



# Ultra-High-Resolution CMOS Monochrome Camera CSC12M25BMP19-01B PRODUCT SPECIFICATION

## CONTENTS

Restriction For Use .....	1
Exemption Clauses .....	2
Notes on using this product .....	3
CAUTIONS ON USE .....	5
1. Overview.....	5
2. Features .....	6
3. Configuration .....	7
4. Option parts .....	7
5. Specification .....	8
6. Command Communication Protocol.....	19
7. Register Map .....	21
8. Function.....	23
9. External-view Drawing.....	33
10. Guarantee .....	35
11. Repair .....	35

**TOSHIBA TELI CORPORATION**

---

## Restriction For Use

---

- Should the equipment be used in the following conditions or environments, give consideration to safety measures and inform us of such usage:
  1. Use of the equipment in the conditions or environment contrary to those specified, or use outdoors.
  2. Use of the equipment in applications expected to cause potential hazard to people or property, which require special safety measures to be adopted.
- This product can be used under diverse operating conditions. Determination of applicability of equipment or devices concerned shall be determined after analysis or testing as necessary by the designer of such equipment or devices, or personal related to the specifications. Such designer or personal shall assure the performance and safety of the equipment or devices.
- This product is not designed or manufactured to be used for control of equipment directly concerned with human life (\*1) or equipment relating to maintenance of public services/functions involving factors of safety (\*2). Therefore, the product shall not be used for such applications.

(\*1): Equipment directly concerned with human life refer to:

Medical equipment such as life-support systems, equipment for operating theaters.

Exhaust control equipment for exhaust gases such as toxic fumes or smoke.

Equipment mandatory to be installed by various laws and regulations such as the Fire Act or Building Standard Law.

Equipment related to the above.

(\*2): Equipment relating to maintenance of public service/functions involving factors of safety refer to:

Traffic control systems for air transportation, railways, roads, or marine transportation.

Equipment for nuclear power generation.

Equipment related to the above.

Although sufficient check is performed about translation of these specifications, we will apply a Japanese sentence, if a doubt should occur.

---

## Exemption Clauses

---

- TELI assumes no responsibility or liability for damage arising from fire, earthquake, an act by a third party or other accidents, or intentional or careless error or misuse by the user, or use under abnormal conditions.
- TELI assumes no responsibility or liability for incidental damages (e.g., loss of business profits or interruption of business) arising from use of or inability to use the camera equipment.
- TELI assumes no responsibility or liability in the case damages or losses are caused by failure to observe the information contained in the operation manual and specifications and interface specifications.
- TELI assumes no responsibility or liability in the case damages or losses are caused by use contrary to the instructions in this operation manual and specifications and interface specifications.
- TELI assumes no responsibility or liability in the case damages or losses are caused by malfunction or other problems resulting from use of equipment or software that is not specified.
- TELI assumes no responsibility or liability in the case damages or losses are caused by repair or modification conducted by the customer or any unauthorized third party (such as an unauthorized service representative).
- Expenses we bear on this product shall be limited to the individual price of the product.
- TELI does NOT guarantee the items that are not described in the specification.

---

## Notes on using this product

---

- Handle carefully

Do not drop the equipment or allow it to be subject to strong impact or vibration, as such action may cause malfunctions. Further, do not damage the connection cable, since this may cause wire breakage.

- Environmental operating conditions

Do not use the product in locations where the ambient temperature or humidity exceeds the specifications.

Otherwise, image quality may be degraded or internal components may be adversely affected. In particular, do not use the product in areas exposed to direct sunlight. Moreover, during shooting under high temperatures, vertical stripes or white spots (noise) may be produced, depending on the subject or camera conditions (such as increased gain). However, such phenomena are not malfunctions.

- Regarding a lens mount

Install a next lens; Dimension of protrusion from flange is equal to or less than 8.1 mm. If a lens does not stand to this condition, it might not be installed to this camera.

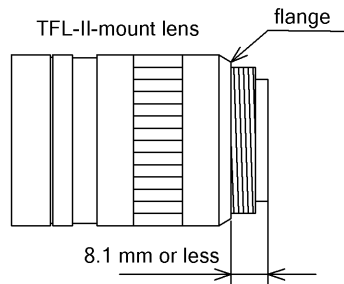

- Check a combination with the lens

Depending on the lens and lighting you use, an image is reflected as a ghost in the imaging area. However, this is not because of a fault of the camera.

In addition, depending on the lens you use, the performance of the camera may not be brought out fully due to deterioration in resolution and brightness in the peripheral area, aberration and others.

Be sure to check a combination with the camera by using the lens and lightning you actually use.

When installing a lens in the camera, make sure carefully that it is not tilted.

In addition, use a mounting screw free from defects and dirt. Otherwise, the camera may be unable to be removed.

---

## Notes on using this product

---

- Avoid intensive light

Do NOT expose the camera's image-pickup-plane to sunlight or other intense light directly. If the part of CMOS sensor is exposed to spot-intensive light, you might get a picture problem like blooming and/or smear. Under the comparison at the same video output level, the shorter the exposure time setting, the more smear is generated.

- Do not expose the camera's image-pickup-plane to sunlight or other intense light directly. Its inner CMOS sensor might be damaged.

- Occurrence of moire

If you shoot thin stripe patterns, moire patterns (interference fringes) may appear. This is not a malfunction.

- Occurrence of noise on the screen

If an intense magnetic or electromagnetic field is generated near the camera or connection cable, noise may be generated on the screen. If this occurs, move the camera or the cable.

- Handling of the protective cap

If the camera is not in use, attach the lens cap to the camera to protect the image pickup surface.

- If the equipment is not to be used for a long duration

Turn off power to the camera for safety.

- Maintenance

Turn off power to the equipment and wipe it with a dry cloth.

If it becomes severely contaminated, gently wipe the affected areas with a soft cloth dampened with diluted neutral detergent. Never use alcohol, benzene, thinner, or other chemicals because such chemicals may damage or discolor the paint and indications.

If the image pickup surface becomes dusty, contaminated, or scratched, consult your sales representative.

---

## CAUTIONS ON USE

---

- When disposing of the camera

Wastes of this product should be separated and discarded in compliance with the various national and local ordinances.

This camera is showing the following symbol to body due to EU environmental regulation (Waste Electrical and Electronic Equipment (WEEE)). However this symbol is applied to only an EU member state.

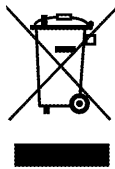

### Phenomena specific to CMOS sensor

- Defective pixels

A CMOS image sensor is composed of photo sensor pixels in a square grid array. Due to the characteristics of CMOS image sensors, over- or under-driving of the pixels results in temporary white or black areas (as if these are noises) appearing on the screen. This phenomenon, which is not a defect is exacerbated under higher temperatures and long exposure times.

- Image shading

The brightness of the upper part of the screen may be different from that of the lower part. Note that this is a characteristic of a CMOS image sensor and is not a fault.

This phenomenon is generated when the shutter speed is fast.

We recommend that the shutter speed of the camera should be slower than 1/100s to reduce the effect by this phenomenon

- Burn-in phenomenon

When it keeps entering light into the camera, the afterimage might be generated. Note that this is a characteristic of a CMOS image sensor and is not a fault.

This phenomenon comes to be generated easily when light enters for the reading period of the image. When the random trigger shutter mode is used, the phenomenon is not generated easily by entering the single-shot light matched to the camera exposure timing with the flash and the LED lighting, etc. If the phenomenon is caused, the phenomenon can be decreased by putting time for a while without entering light.

## 1. Overview

This CMOS camera is an Ultra-High-resolution monochrome camera employing a 12,580 thousand pixel readout system CMOS sensor.

## 2. Features

High speed output at Ultra-High-resolution pixel.

The TOSHIBA TELI's proprietary 1.9 type 12,580 thousand pixel Ultra-High-resolution CMOS sensor outputs the entire 12,580 thousand pixels in a speed as high as 25fps. A high amount of information in 330M Byte/Sec. output data rate is obtainable in 8bit mode and 660M Byte/Sec. output data rate is obtainable in 10bit mode.

WOI (Window Of Interest)

WOI (Window Of Interest) of a partial readout function optimum to diversifying high-speed image processing is available.

It supports a variable frame rate to increase the frame rate by reading an arbitrary area by specifying an address in horizontal and vertical directions.

Global shutter

As it employs a global electronic shutter similar to a CCD image sensor, clear images of even fast-moving object are obtainable with less blur.

Random trigger shutter

Photo images can be imported in any timing by inputting external trigger signals.

Camera Link interface

Image output and camera control interfaces employ the camera link standard.

The dual MDR connector supporting Camera Link Medium Configuration outputs the entire 12,580 thousand pixels in a speed as fast as 25fps. As it also supports Camera Link Base Configuration to output the entire 12,580 thousand pixels in a speed as high as 12.5fps by a single one-sided MDR connector, it can support a wide variety of image processors.

Wide dynamic range

A wide dynamic range can be achieved by compressing brightness information of an object by employing a multi-slope multiple storage method.

Binning

Signals can be output in all effective areas in about 41.8fps by reading 2(H)x2(V) pixels as one pixel.



## 5. Specification

### [Electrical specification]

Imager	CMOS image sensor
▪ Number of active pixels	4096 (H) × 3072 (V)
▪ pixel size	6 μm (H) × 6 μm (V) (Square-grid array)
▪ Scanning area	24.576 mm(H) x 18.432 mm(V)
▪ Optical size	Equivalent to 1.9 type
Scanning system	Progressive
Aspect ratio	4:3
Synchronization method	Internal synchronization
Sensitivity	2000 lx, F5.6, 3000 K
Minimum object illuminance	30 lx (F2.8, GAIN MAX, reading all pixels, image level 50%)
Image output	Compliant with Camera Link standard
▪ Output mode	Switchable between Base and Medium configuration (Factory setting: Medium configuration)
▪ Data	8 / 10 / ex8 bit switching (Factory default: 8 bit)
▪ Readout mode (Medium configuration, Shutter OFF)	
All pixel readout	Approx. 25 fps / 4096(H) × 3072(V)
Binning	Approx. 41.8 fps / 2048(H) × 1536(V)
Sub sampling	2x2 : Approx. 50fps / 2048(H) × 1536(V) 4x4 : Approx. 100fps / 1024(H) × 768(V) 8x8 : Approx. 200 fps / 512(H) × 384(V)
WOI	Depends on the window setting.
Gain	
▪ Digital gain	0 to +18 dB [180step, 1step= Approx. 0.1dB] (Factory default : 0 dB)
Set-up level	0 to Approx.+13% [528step] (Factory default : Approx.+3.9%...264 )
Gamma	1.0 (standard)
Power supply voltage	DC12 V ± 10 % (ripple 50 mV(p-p) or less) The power supply standing up must increase up to the stipulated voltage monotonously.
Power consumption	Approx. 5.4 W

### [Electrical shutter specification]

- |                        |  |
|------------------------|--|
| (1) Shutter Speed      | Shutter OFF or 1/20,000 to 2 sec   |
|                        | The exposure time at shutter OFF is different depending on the reading mode. (Factory default : Shutter OFF) |
| Random Trigger Shutter | ON / OFF switching (Factory default : OFF)   |
| • Fixed mode           | The exposure time depends on the shutter speed setting   |
| • Pulse width mode     | The exposure time depends on the pulse width.  |
|                        | Minimum pulse width : 50 $\mu$ sec   |
|                        | (Minimum exposure time: 50 $\mu$ sec)  |

• Note: The brightness of the upper part of the screen may be different from that of the lower part. Note that this is a characteristic of a CMOS image sensor and is not a fault. This phenomenon is generated when the shutter speed is fast. We recommend that the shutter speed of the camera should be slower than 1/100s to reduce the effect by this phenomenon.

### [Internal sync signal specification]

- |                       |                                    |
|-----------------------|------------------------------------|
| (1) Driving frequency |                                    |
| • Output mode         | *Medium configuration, Shutter OFF |
| All pixel readout     | Horizontal : Approx.75 kHz         |
|                       | Vertical : Approx.25 Hz            |
| Binning               | Horizontal : Approx.64.5 kHz       |
|                       | Vertical : Approx.41.8 Hz          |
| WOI                   | By window setting                  |

### [Input signal specification]

- |                                  |   |
|----------------------------------|---|
| (1) TRIG                         | Camera Link I/F and DC IN connector input               |
| • Signal level (DC IN connector) | TTL level   |
| • Polarity                       | Positive/Negative switching (Factory default: Negative) |
| • Pulse width                    | 50 $\mu$ sec or more                                    |

### [Output signal specification]

None

**[Mechanical spec]**

- (1) Lens mount TOSHIBA TELL's unique TFL-II mount
- Mount screw M48mm P=0.75
  - Positioning engagement part  $\Phi 50\text{mm H7}$
  - Flange back 17.5 mm

Dimensions 75 mm (W) × 75 mm (H) × 69.5 mm (D)  
(Not including protrusion)

Weight Approx.450 g

Camera body grounding: insulation status

Conductive between circuit GND and camera body

**[Optical axis accuracy]**

	Position accuracy of effective pixels		Rotation accuracy of effective pixels ( $\theta$ )	Flange focal distances (Flange back) (For 17.500mm)	Parallel accuracy
	(X)	(Y)			
Optical axis accuracy	$\pm 25\mu\text{m}$	$\pm 25\mu\text{m}$	$\pm 0.07^\circ$	$\pm 50\mu\text{m}$	60 $\mu\text{m}$

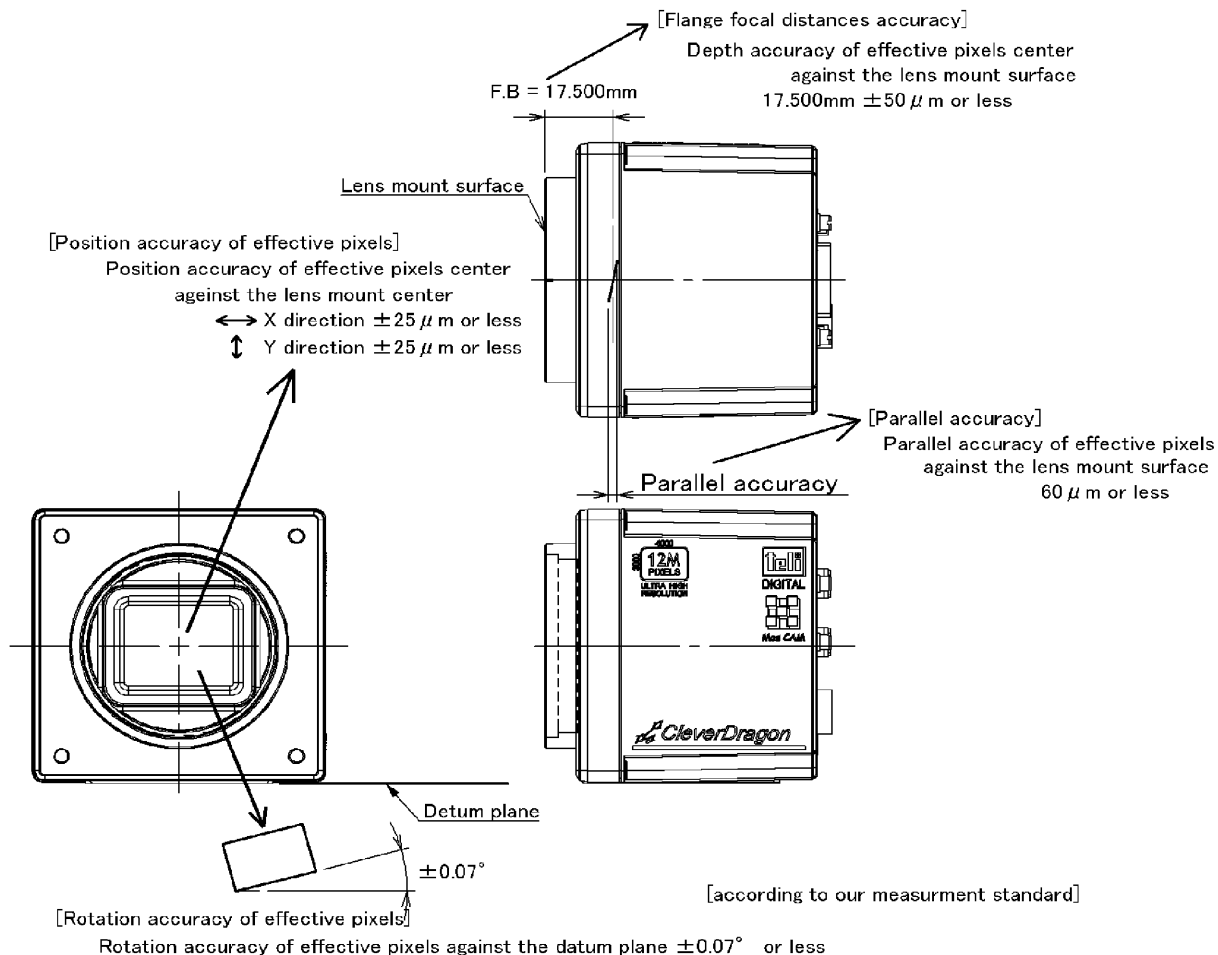

D4175208B

**[Operating ambient conditions]**

(1) Performance assurance	Temperature :	0 to +40 degrees C
	Humidity :	10% to 90% (No dew formation)
Operation guaranteed	Temperature :	-5 to +50 degrees C
	Humidity :	10% to 90% (No dew formation)
Storage	Temperature :	-20 to +60 degrees C
	Humidity :	90% or less (No dew formation)

**[Typical ambient conditions]**

**Spectral Sensitivity Specification for CSC12M25BMP19 -01B**

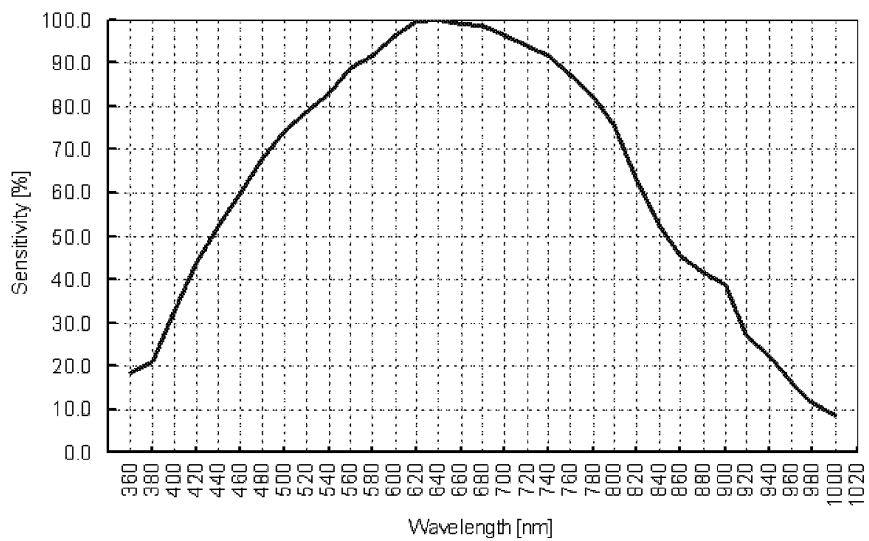

(\*The lens characteristics and light source characteristics are not reflected in table.)

**[Various safety standards]**

- (1) Electro-Magnetic Compatibility
  - EMI(Electro-Magnetic Interference) EN61000-6-4
  - EMS(Electro-Magnetic Susceptibility) EN61000-6-2
- FCC FCC Part 15 Subpart B class A

**THIS DEVICE HAS COMPLIES WITH PART 15 OF THE FCC RULES.  
OPERATION IS SUBJECT TO THE FOLLOWING TWO CONDITIONS:  
(1)THIS DEVICE MAY NOT CAUSE HARMFUL INTERFERENCE, AND (2)THIS DEVICE  
MUST ACCEPT ANY INTERFERENCE RECEIVED. INCLUDING INTERFERENCE THAT  
MAY CAUSE UNDESIRED OPERATION.**

**[Communication specification]**

- (1) Communication speed 9600 / 19200 / 38400 / 57600 bps switching
- Start bit 1bit
- Data bit 8bit
- Stop bit 1bit
- Parity None
- Handshake None

**[Environmental Correspondence]**

It complies with the following instruction.

- (1) RoHS conformity
- (2) Administrative Measure on the Control of Pollution Caused by Electronic Information Products (Popular name : China RoHS)
  - a) Environmental usage period refer to 9.2
  - b) Poisonous substance content table refer to 9.2
  - c) Toxic substance content table refer to 9.2

**[Connector pin assignment]**

(1) Video output/controlling (Camera Link Medium Configuration) CAMERA LINK1・2

・ Connector type: MDR 26-PIN connector 10226-2210PE (Manufactured by 3M)

●Connector name : CAMERALINK1

Pin No.	I/O	Signal name	Pin No.	I/O	Signal name
1	-	GND	14	-	GND
2	O	X0-	15	O	X0+
3	O	X1-	16	O	X1+
4	O	X2-	17	O	X2+
5	O	X CLK OUT-	18	O	X CLK OUT+
6	O	X3-	19	O	X3+
7	I	Ser TC (RxD) +	20	I	Ser TC (RxD) -
8	O	Ser TFG (TxD) -	21	O	Ser TFG (TxD) +
9	I	CC1 (TRIG) -	22	I	CC1 (TRIG) +
10	I	CC2 (MULTI) +	23	I	CC2 (MULTI) -
11	I	CC3-	24	I	CC3+
12	I	CC4+	25	I	CC4-
13	-	GND	26	-	GND

●Connector name : CAMERALINK2

Pin No.	I/O	Signal name	Pin No.	I/O	Signal name
1	-	GND	14	-	GND
2	O	Y0-	15	O	Y0+
3	O	Y1-	16	O	Y1+
4	O	Y2-	17	O	Y2+
5	O	Y CLK OUT-	18	O	Y CLK OUT+
6	O	Y3-	19	O	Y3+
7	-	100ohm terminated(20)	20	-	100ohm terminated(7)
8	-	N.C.	21	-	N.C.
9	-	N.C.	22	-	N.C.
10	-	N.C.	23	-	N.C.
11	-	N.C.	24	-	N.C.
12	-	N.C.	25	-	N.C.
13	-	GND	26	-	GND

Power supply connector DC IN

- Connector (camera side) : HR10A-10R-12PB(71) (HIROSE ELECTRIC)
- Compatible plug (cable side): Equivalent to HR10A-10P-12S(73) (HIROSE ELECTRIC) or equivalent

Pin No.	I/O	Signal name
1	-	GND
2	I	+12V
3	-	GND
4	-	N.C.
5	-	GND
6	-	N.C.
7	-	N.C.
8	-	GND
9	-	N.C.
10	-	N.C.
11	I	TRIG
12	-	GND

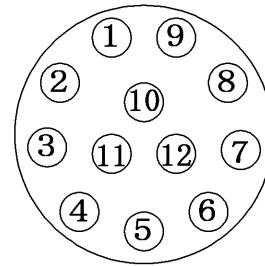

Rearview

[Camera bit assignment]

**Medium Configuration**

Camera Out	8bit	10bit
DATA OUT1 =	A[7:0]	A[9:0]
DATA OUT2 =	B[7:0]	B[9:0]
DATA OUT3 =	C[7:0]	C[9:0]
DATA OUT4 =	D[7:0]	D[9:0]

Port/bit	8bit	10bit
Port A0	A0	A0
Port A1	A1	A1
Port A2	A2	A2
Port A3	A3	A3
Port A4	A4	A4
Port A5	A5	A5
Port A6	A6	A6
Port A7	A7	A7
Port B0	B0	A8
Port B1	B1	A9
Port B2	B2	n/a
Port B3	B3	n/a
Port B4	B4	B8
Port B5	B5	B9
Port B6	B6	n/a
Port B7	B7	n/a
Port C0	C0	B0
Port C1	C1	B1
Port C2	C2	B2
Port C3	C3	B3
Port C4	C4	B4
Port C5	C5	B5
Port C6	C6	B6
Port C7	C7	B7
Port D0	D0	D0
Port D1	D1	D1
Port D2	D2	D2
Port D3	D3	D3
Port D4	D4	D4
Port D5	D5	D5
Port D6	D6	D6
Port D7	D7	D7
Port E0	n/a	C0
Port E1	n/a	C1
Port E2	n/a	C2
Port E3	n/a	C3
Port E4	n/a	C4
Port E5	n/a	C5
Port E6	n/a	C6
Port E7	n/a	C7
Port F0	n/a	C8
Port F1	n/a	C9
Port F2	n/a	n/a
Port F3	n/a	n/a
Port F4	n/a	D8
Port F5	n/a	D9
Port F6	n/a	n/a
Port F7	n/a	n/a

**Base Configuration**

Camera Out	8bit	10bit
DATA OUT1 =	A[7:0]	A[9:0]
DATA OUT2 =	B[7:0]	B[9:0]
DATA OUT3 =	(N/A)	(N/A)
DATA OUT4 =	(N/A)	(N/A)

Port/bit	8bit	10bit
Port A0	A0	A0
Port A1	A1	A1
Port A2	A2	A2
Port A3	A3	A3
Port A4	A4	A4
Port A5	A5	A5
Port A6	A6	A6
Port A7	A7	A7
Port B0	B0	A8
Port B1	B1	A9
Port B2	B2	n/a
Port B3	B3	n/a
Port B4	B4	B8
Port B5	B5	B9
Port B6	B6	n/a
Port B7	B7	n/a
Port C0	C0	B0
Port C1	C1	B1
Port C2	C2	B2
Port C3	C3	B3
Port C4	C4	B4
Port C5	C5	B5
Port C6	C6	B6
Port C7	C7	B7

The allocation of the port conforms to the Camera Link standard.

## [Dip switch setting]

Various settings are available with the dip switch on the back.

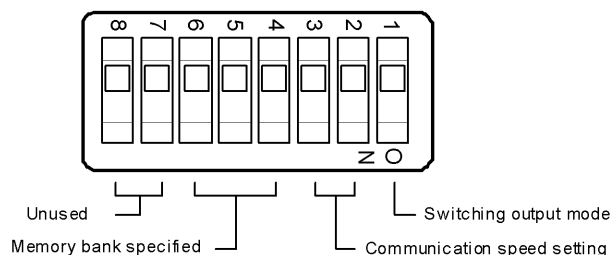

“\*” is Factory default

### (1) Output mode switching

Switch between Medium Configuration and Base Configuration.

The power of the camera needs be turned on again to switch modes.

SW1	Output mode
OFF	* Medium Configuration
ON	Base Configuration

### (2) Baud rate setting

The speed of the serial communication can be set by the camera link.

The power of the camera needs be turned on again to switch modes.

SW2	SW3	Baud rate
OFF	OFF	* 9600 bps
ON	OFF	19200 bps
OFF	ON	38400 bps
ON	ON	57600 bps

### (3) Specifying a memory bank before starting

Specify a memory bank to be referenced before turning on the power of the camera for

SW4 through SW6. The power of the camera needs be turned on again to switch modes.

SW4	SW5	SW6	Memory bank
OFF	OFF	OFF	* Bank 1
ON	OFF	OFF	Bank 2
OFF	ON	OFF	Bank 3
ON	ON	OFF	Bank 4
OFF	OFF	ON	Bank 5
ON	OFF	ON	Bank 6
OFF	ON	ON	Bank 7
ON	ON	ON	Bank 8

\*SW7 and SW8 are not used. (Fixed to OFF)

**[Timing Chart]**

(1) Horizontal Timing

\* For Medium configuration    Figures in parentheses are for Base configuration

1) Reading all pixels

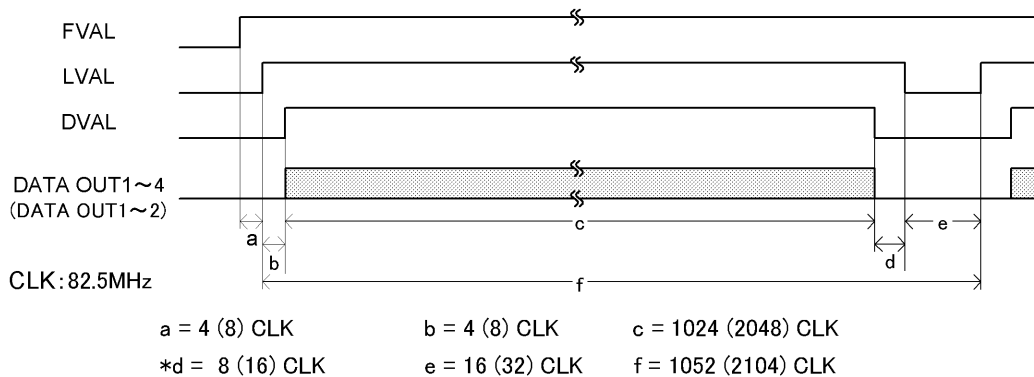

(\* The sign is that the number of CLKs might change. )

2) CLK rate

•Medium Configuration

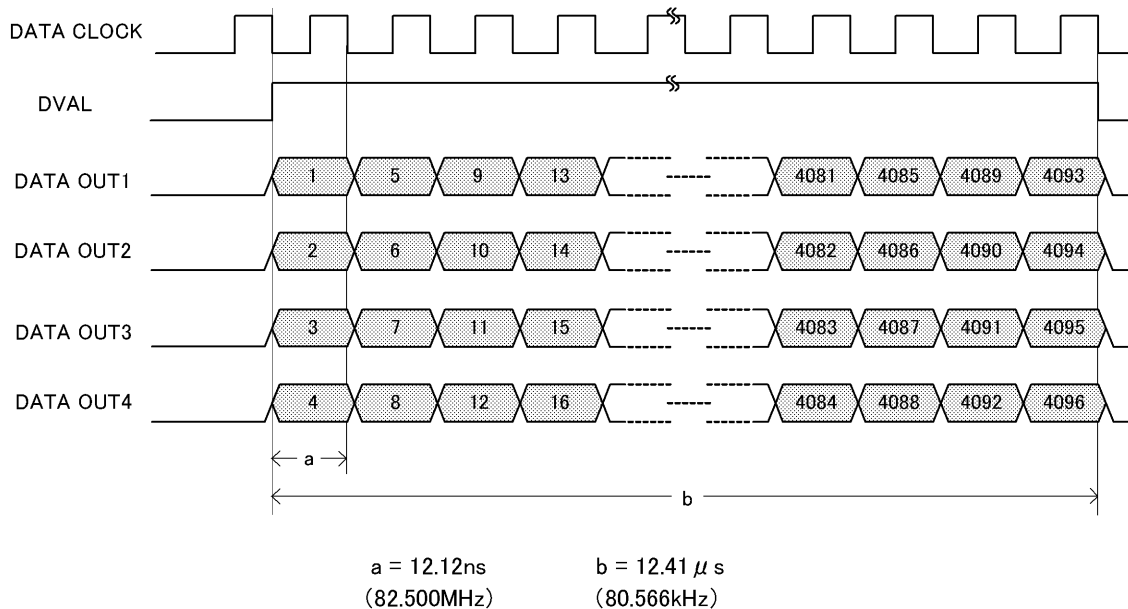

●Base Configuration

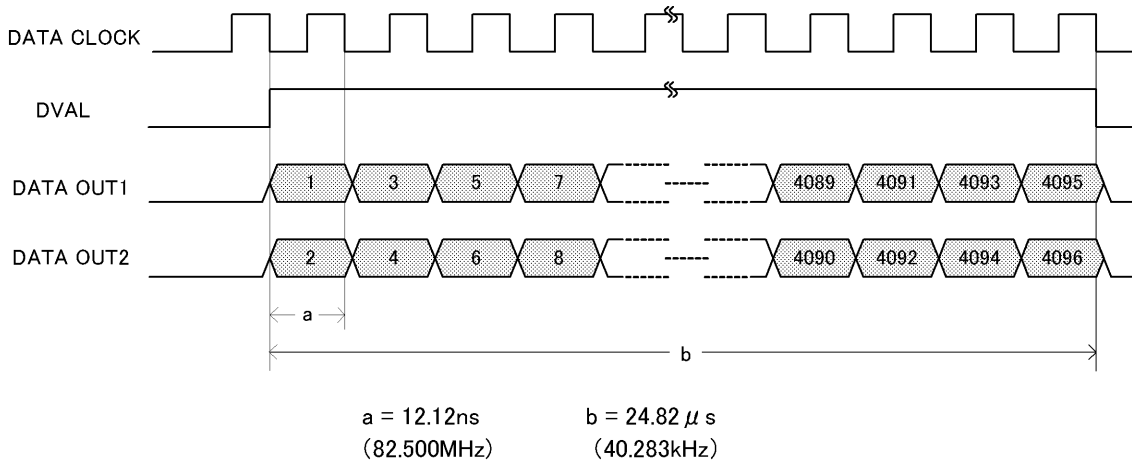

(2) Vertical Timing

\*For Medium configuration    Figures in parentheses are for Base configuration

1) All pixel readout

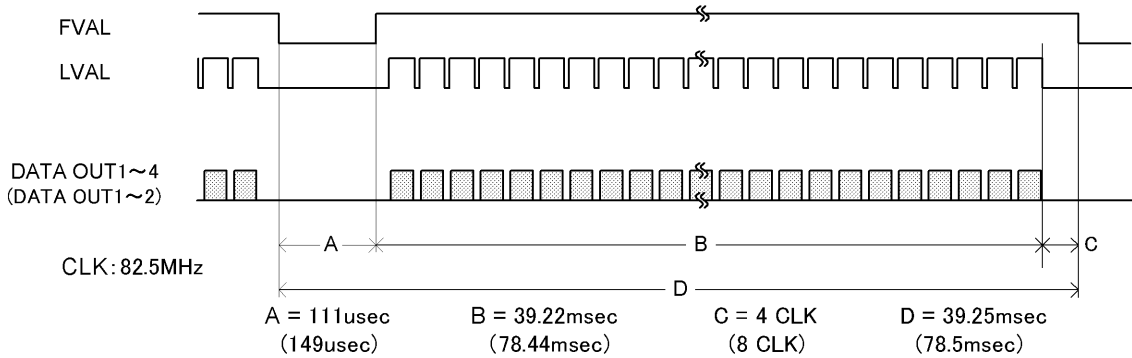

⚠Note: The frame rate changes according to the shutter speed when the shutter is ON.  
 (The period "A" in the chart indicates the period of the shutter speed.)

## 6. Command Communication Protocol

The command communication protocol is the TELL standard method (method in which parameters are set in the registers in the camera).

In command send/receive operation, hexadecimal address and data are converted to ASCII data.

All ASCII alphabetic characters used are uppercase characters.

### (1) Write to a register

To write data in a register, send a command, as follows. (Address' max-length is 2 bytes, and Data's max-length is 8 bytes)

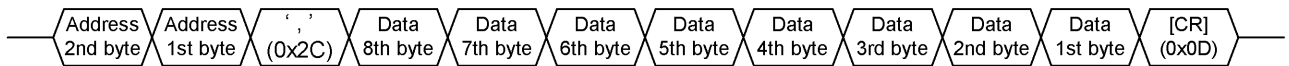

For example, to write data 0x38 to address 0x76, send a command, as follows:

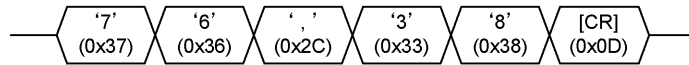

Moreover, because the data size of each address that can be set is decided, the transmission for the width of data to exceed the data size is not accepted.

For instance, five bytes or more cannot be received though it is possible to receive up to four bytes because the data size of address 0xA0 (shutter speed denominator register) is two bytes.

("A0,00001000" cannot be received though "A0,1000" can be received. )

The camera responds to the write command with No Error (ACK) or Error (NAK), as follows:

No Error (ACK):

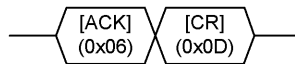

Error (NAK):

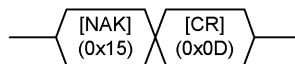

\*Because max five kinds of data is needed for the setting about a part of the register that relates to WOI, the setting is reflected by writing the register for "Set value application".

\*The response to the command might become about three seconds by the internal processing of camera.

\*It is not possible to communicate for the exposure period at the random trigger shutter.

(2) Reading the register

To read data from a register, send ' , (comma)', 'R', 'Q' and [CR] code following the address.

For example, to read data in address 0x91, send a command, as follows:

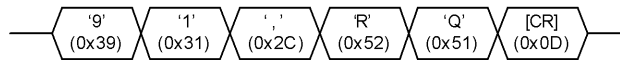

The camera responds to the read request, as follows (Data's max-length is 8 bytes):

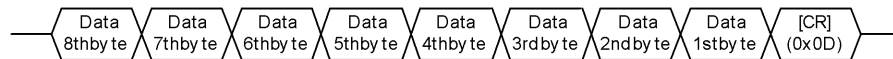

Actually, the camera responds to the read request as minimum data length: For example, to read data 0x10 to address 0x91, the camera responds as follows:

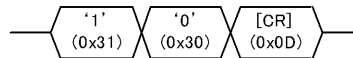

## 7. Register Map

The following accesses are available via the camera link serial interface.

Address	Access	Memory	CMOS Monochrome Camera CSC12M25BMP19-01B
0x00	R. O.	—	Manufacturer(Maker) name ASCII format
		—	
0x0F	R. O.	—	Model name ASCII format
0x10	R. O.	—	
		—	Serial number ASCII format
0x2F	R. O.	—	
0x30	R. O.	—	Firmware version ASCII format
		—	
0x47	R. O.	—	FPGA1 version ASCII format
0x48	R. O.	—	
		—	FPGA2 version ASCII format
0x4F	R. O.	—	
0x50	R. O.	—	CPLD1 version ASCII format
		—	
0x57	R. O.	—	Register map version ASCII format
0x58	R. O.	—	
		—	Reserved
0x5F	R. O.	—	
0x60	R. O.	—	Status
		—	
0x67	R. O.	—	Extended status
0x68	N. A.	—	
0x69	R. O.	—	Reserved
0x6A	R. O.	—	
0x6B	N. A.	—	Check memory bank
		—	
0x6C	R. O.	—	Save memory
0x6D	W. O.	—	
0x6E	R/W	—	Call memory
0x6F	W. O.	—	
0x70	R/W	○	Initialize memory
		—	
0x72	N. A.	—	Setup
		—	
0x75	N. A.	—	Reserved
0x76	R/W	○	
0x77	N. A.	—	Gain
		—	
0x85	N. A.	—	Reserved
0x86	R/W	—	
0x87	R/W	○	Output control
0x88	R/W	—	
0x89	N. A.	—	Number of output bits
		—	
0x8A	N. A.	—	Test pattern
0x8B	R/W	○	
0x8C	N. A.	—	Reserved
0x8D	N. A.	—	
0x8E	N. A.	—	Defective pixel correction
0x8F	N. A.	—	
0x90	R/W	○	Reserved
		—	
0x91	R/W	○	Scan mode
0x92	R/W	○	
0x93	R/W	○	Shutter mode
		—	
0x94	R/W	○	Random trigger mode
0x95	N. A.	—	
		—	Trigger polarity
0x9F	N. A.	—	

Access
R/W : Read/Write possible
R. O. : Read Only
W. O. : Write Only
N. A. : Not Available

Address	Access	Memory	CMOS Monochrome Camera CSC12M25BMP19-01B
0xA0	R/W	○	Shutter speed denominator
0xA2	N. A.	—	Reserved
0xA3	N. A.	—	Reserved
0xA4	R/W	○	Shutter speed numerator
0xA5	N. A.	—	Reserved
		—	
0xBF	N. A.	—	Reserved
0xC0	W. O.	—	WOI update
0xC1	R/W	○	WOI area number
0xC2	R/W	○	WOI horizontal start coordinate
0xC4	R/W	○	WOI vertical start coordinate
0xC6	R/W	○	WOI horizontal width
0xC8	R/W	○	WOI vertical height
0xCA	N. A.	—	Reserved
0xCB	R/W	—	Save/call WOI bank
0xCC	R/W	○	WOI area effective
0xD0	R/W	—	Defect pixel correction data /addressing
0xD2	N. A.	—	Reserved
0xD3	W. O.	—	Defect pixel correction data/save
0xD4	R/W	—	Defect pixel correction data/data
0xD8	R/W	—	Specify user area/address
0xDA	R/W	—	Specify user area/data
0xDB	W. O.	—	Erase user area
0xDC	R/W	○	Number of bytes to read user area
0xDD	N. A.	—	Reserved
0xDE	N. A.	—	Reserved
0xDF	N. A.	—	Reserved
0xE0	N. A.	—	Reserved
0xE1	R/W	○	Multi slope
0xE2	R/W	○	Step correction
0xE3	R/W	○	Step interpolation
0xE4	R/W	○	FPN correction
0xE5	W. O.	—	FPN correction data/save
0xE6	R/W	○	FPN correction data/call
0xE7	W. O.	—	FPN correction data/creation
0xE8	R/W	○	Low gain
		—	
0xFF	N. A.	—	Reserved

<b>Access</b> R/W : Read/Write possible R.O. : Read Only W.O. : Write Only N.A. : Not Available
---

## 8. Function

### 8.1. Scan mode

The image output is output from the camera link connector, and can take the output image by Frame grabber board. The frame rate and the resolution of the output image that this camera corresponds are as follows. (At Medium configuration, shutter OFF. )

Output mode	Setting	Frame rate	Output size
All pixel readout		Approx.25 fps	4096 (H) × 3072 (V)
Binning		Approx.41.8 fps	2048 (H) × 1536 (V)
Sub sampling	2 x 2	Approx. 50 fps	2048 (H) × 1536 (V)
	4 x 4	Approx. 100 fps	1024 (H) × 768 (V)
	8 x 8	Approx. 200 fps	512 (H) × 384 (V)
WOI		Depends on the window setting	
Binning-WOI		Depends on the window setting	

\*As for the frame that switched the mode when continuously operating, the image of the brightness not intended might be output.

#### 8.1.1. All pixel readout

The camera reads all pixels (4096(H) × 3072(V) pixels) in about 25 fps.

#### 8.1.2. Binning

The camera reads all effective areas in about 41.8fps by binning (2x2) for all pixels (4096(H) × 3072(V) pixels). As it reads adjacent 4 pixels as one pixel, the resolution reduces. However, as the pixel noise is averaged, it can output lower noise than that is produced when it reads all pixels.

Complex operation with WOI and sub sampling is not available.

#### 8.1.3. Sub sampling

It reads all effective areas in high speed by scanning in pixel skipping.

Complex operation with binning and WOI is not available.

#### 8.1.4. WOI

Only arbitrary area can be read. Areas can be read in high speed by skipping unwanted areas.

Complex operation with binning and sub sampling is not available.

### 8.1.5. Binning-WOI

Only arbitrary area can be read. Areas can be read in high speed by skipping unwanted areas.

Complex operation with binning and sub sampling is not available.

## 8.2. Shutter mode

### 8.2.1 Shutter OFF

The shutter speed changes in this mode depending on the frame rate.

Shutter speed is defined by the following calculation.

$$\text{Shutter speed} = \text{Frame rate (msec)} - 32.6(\mu \text{ sec})$$

### 8.2.2 Shutter ON

In this mode, the shutter speed can be handled by the value in the register.

( From 1/20,000 sec to 2 sec : selectable)

$$\text{Frame rate} = \text{Shutter speed} + \text{Readout time}$$

### 8.2.3 Random trigger shutter

Images can be taken and imported at any timing by inputting an external trigger signal in a random trigger shutter mode.

- External trigger signals can be input from either the camera link I/F CC1 or the DC IN connector. However, signals cannot be input at the same time. Fix an unused input to Low.
- It starts exposure at a rising trigger edge when the polarity is set to positive polarity while it starts exposure at a negative-going trigger edge when the polarity is set to negative polarity.
- Random trigger shutter operates in either the fixed mode and the pulse width mode and has different ways to determine the exposure time depending on the mode.
- The command communication is not available for the exposure period.

### 8.2.3.1. Fix mode

- The exposure time is determined by the set value of the shutter speed.

\*Example of timing charts to expose all pixels

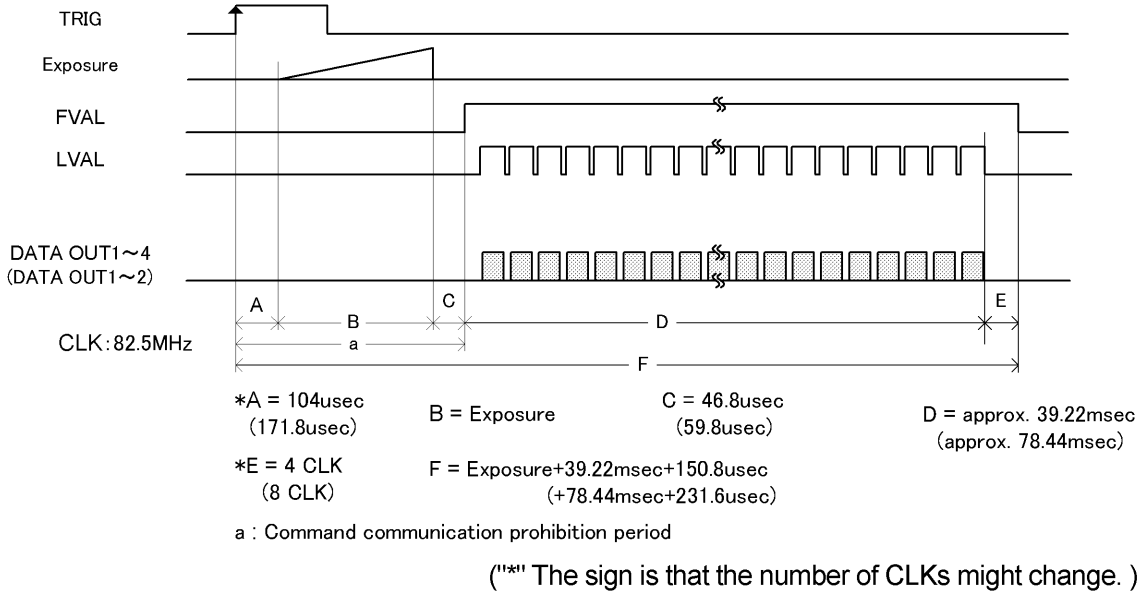

### 8.2.3.2. Pulse width mode

- The exposure time is determined by the pulse width (exposure time = pulse width + 2CLK).
- The pulse width should be more than 50 μsec.

\*Example of timing charts to expose all pixels

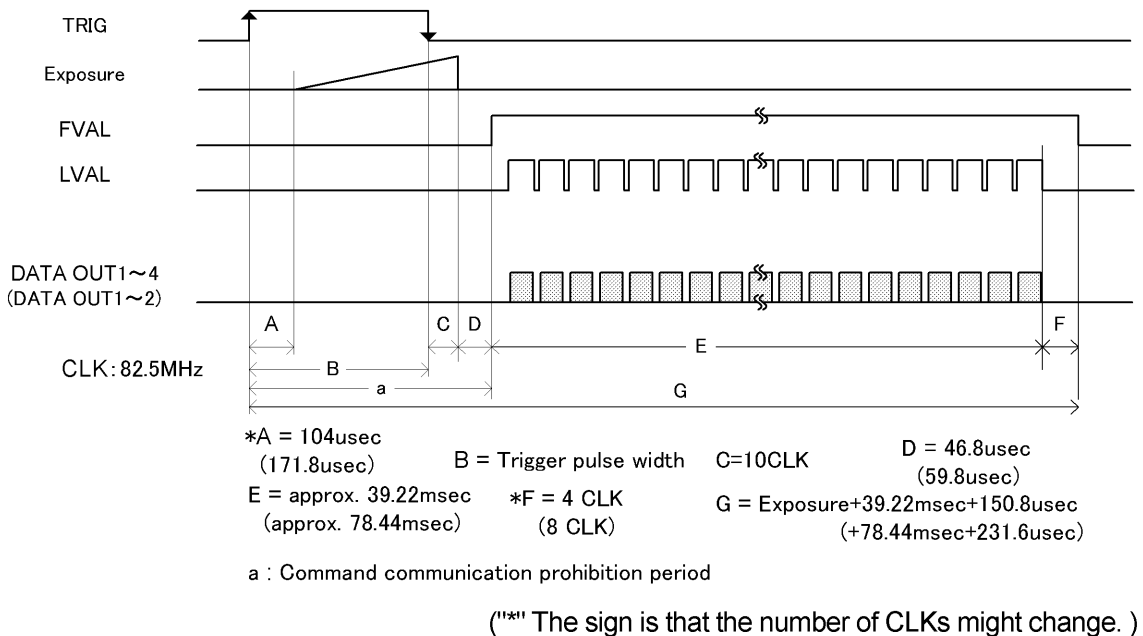

### 8.3. WOI (Window Of Interest)

Only arbitrary areas can be read by specifying an address in horizontal and vertical directions.

Area setting has the following conditions.

- Number of windows: 1 to 28
- Setting position: H: Integral multiple of 4 columns  
V: Integral multiple of one row
- Window size: H: Integral multiple of 4 columns (minimum size: 16)  
V: Integral multiple of one row (minimum size: 1)
- Overlapping of windows: Possible
- Others
  - (1)Frame rate There is no proportional relation between the window area and the frame rate.
  - (2)Set values of the coordinate and the size Set the coordinate and the size to fit the effective pixel area. Values cannot set beyond the effective pixel area.
  - (3)Memory WOI setting can be saved in memory banks 1- 8.

#### 8.3.1 Image output for WOI

Images are outputted per line. Therefore, when multiple windows are set on the same line, images of multiple windows are included in the image output of the line.

##### (1) When multiple windows are set on the same line

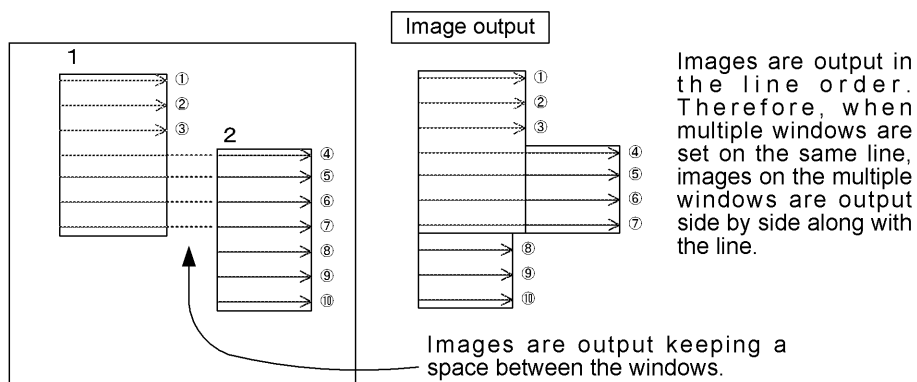

(2) When multiple windows overlap

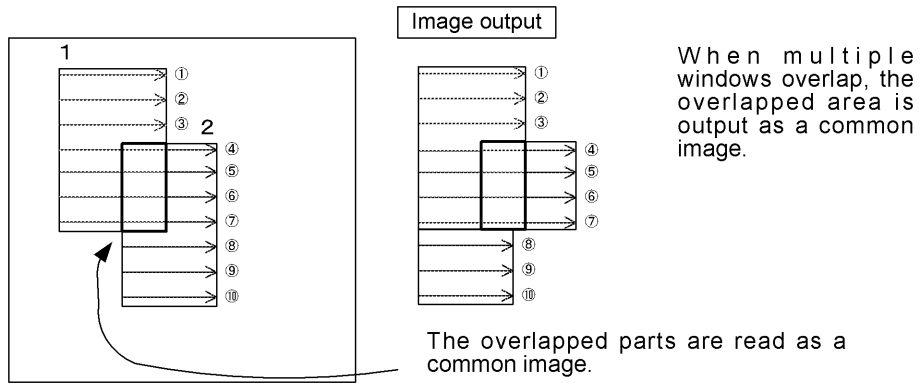

8.4 Binning-WOI mode

Only arbitrary areas can be read by specifying an address in horizontal and vertical directions.

Area setting has the following conditions.

- Number of windows: 1 to 28
- Setting position: H: Integral multiple of 8 columns  
V: Integral multiple of 2 rows
- Window size: H: Integral multiple of 8 columns (minimum size: 16)  
V: Integral multiple of 2 rows (minimum size: 2)
- Overlapping of windows: Possible
- Others

(1)Frame rate There is no proportional relation between the window area and the frame rate.

(2)Set values of the coordinate and the size Set the coordinate and the size to fit the effective pixel area. Values cannot set beyond the effective pixel area.

(3)Memory WOI setting can be saved in memory banks 1- 8.

### 8.5 Multi-slope (to be implemented)

A wide dynamic range is obtainable through exposure up to two times.

Note that the tone may not be correctly represented for the point where the slope switches.

Fixed pattern noise may increase depending on the setting.

With this camera, three modes from which the shutter speed of 2nd slope differs by shutter speed setup of 1st slope can be chosen. However, the shutter speed of 2nd slope does not become shorter than 50microsec.

It cannot be used in the time of Shutter OFF, and random trigger shutter pulse width mode.

Mode	Reset level of 1 <sup>st</sup> slope	Exposure time of 2 <sup>nd</sup> slope
1	Approx. 75%	1/4 of 1 <sup>st</sup> slope
2	Approx. 75%	1/16 of 1 <sup>st</sup> slope
3	Approx. 75%	1/64 of 1 <sup>st</sup> slope

\*Example of timing charts to random trigger shutter fix mode.

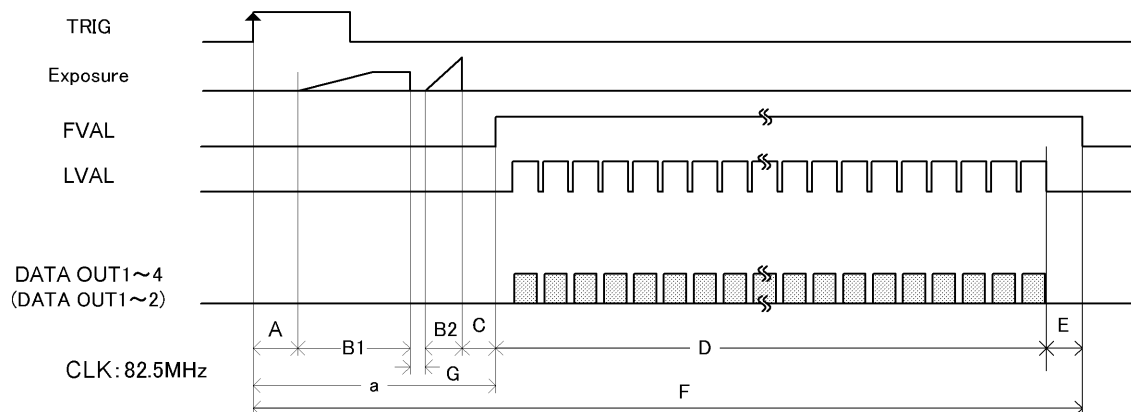

\*A = 104usec (171.8usec)      B1 = 1st slope of exposure      B2 = 2nd slope of exposure  
 C = 46.8usec (59.8usec)      D = approx. 39.22msec (approx. 78.44msec)      \*E = 4 CLK (8 CLK)  
 G = 12CLK      F = Exposure+39.22msec+150.8usec (+78.44msec+231.6usec)  
 a : Command communication prohibition period

(\*\*) The sign is that the number of CLKs might change. )

## 8.6 FPN correction

FPN(Fixed Pattern Noise) is corrected by taking the black image, and doing the subtraction processing in the camera.

FPN data corresponds to a normal shutter and the random trigger shutter and the data is preserved in "Memory 0" before shipment . Please call and load data in each shutter mode.

The preserved data becomes two patterns though the correction data can be acquired in any camera settings. Because FPN is changed by the setting and the environment of the camera, the re-acquisition of the correction data might become necessary by the state of the camera at that time. It is not possible to write it in "Memory 0".

Area..... All pixels

Number of saving data..... 2 ("Memory 1, 2")

\*Please shut out the light and maintain it in the state that the image is regularly output.

\*It is not possible to correct the sensitivity varies of pixels.

\*It takes about 1-2 minutes to acquire and to preserve the correction data. Meanwhile, please do not turn off the power supply of the camera.

\*FPN collection does not work in Multi-slope mode.

\*Please refer to the interface specifications for a concrete manner of operation.

## 8.7 Defect pixels correction

This is the correction functionality that can average the next both right and left pixels.

Therefore the effectiveness of this collection would get weak in case that the defective pixels are located at the both edge of the window or that the defective pixels lie in a line.

The user can select any pixels.

The correction data that can be preserved doesn't obtain the corrective effect in Binning and the Sub-sampling mode with different field angle because of one kind of. In that case, please correct the correction data according to the output mode.

The maximum pixel that can be set..... 2048 pix

\*Please refer to the interface specifications for a concrete manner of operation.

## 8.8 Gradation

The bit depth of the video is selectable either 8 bit or 10 bit.

Because of the specification of the sensor, all of the data and the depth cannot perform at 100%. The data is adjusted so that the video data can perform at maximum by adding the digital gain. Therefore some of data might be lost.

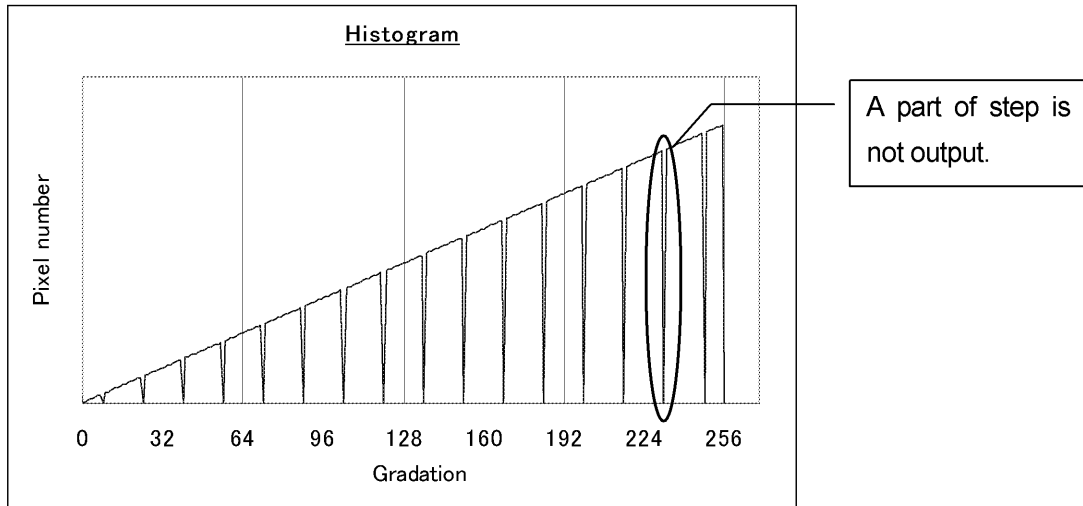

Fig 8.8. Example of outputting step of this camera(8bit output)

The expression of the step can be changed by the following functions.

### 8.8.1 Step correction

OFF/ON can be operated (factory setting: ON).

If this function is turned off, the digital gain in camera is turned off. Therefore, the lack of the step is lost. However, the saturation point might not reach up to the maximum step.

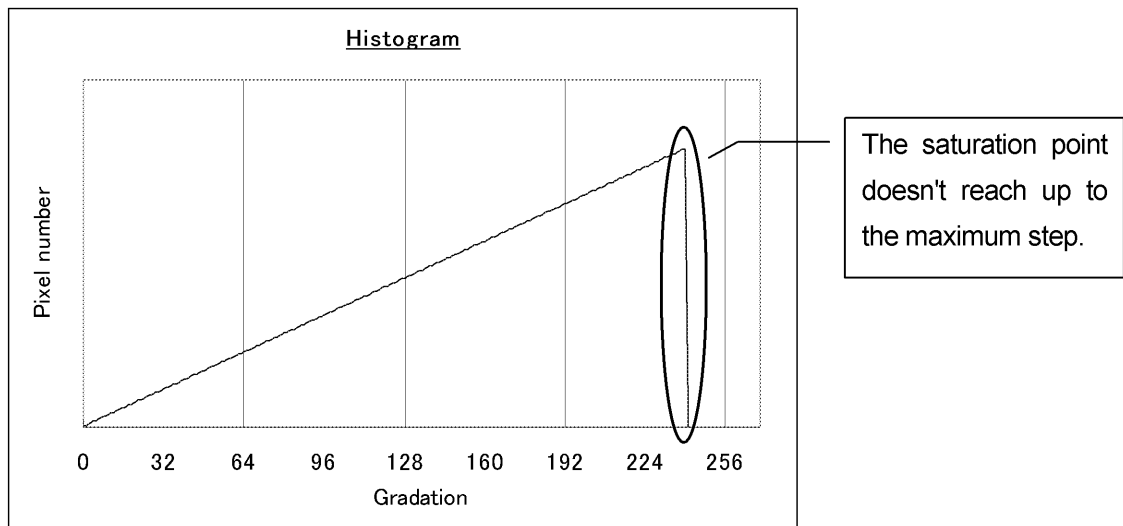

Fig 8.8.1. Example of step correction function (8bit output)

### 8.8.2 Step interpolation

OFF/ON can be operated (factory setting: OFF).

The step missed by turning on this function is interpolated.

However, the lack step is not completely interpolated.

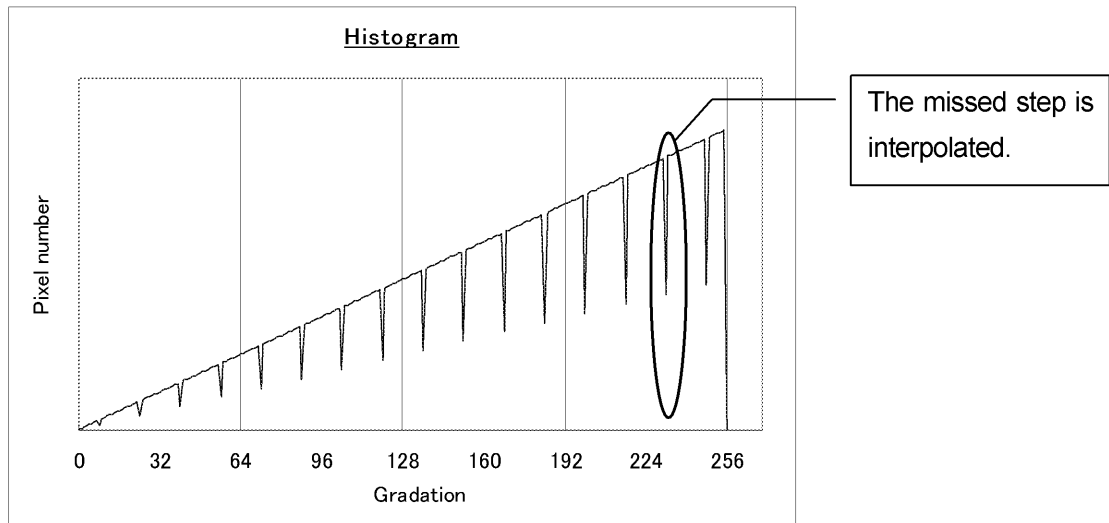

Fig 8.8.2. Example of step interpolation function (8bit output)

### 8.8.3 Extended 8bit output mode

It is an extended mode of 8bit output.

It becomes the same speed as 10 bit output of the readout speed of WOI and Binning mode though the lack of the step decreases in this mode.

### 8.9 Low gain

OFF/ON can be operated (factory setting: OFF).

Sensitivity usually becomes about 75% at turning on this function. The image that suppresses the noise can be acquired though sensitivity decreases.

### 8.10 Output of test pattern

Some test patterns can be output by cutting the output of the sensor.

It is output by the frame rate matched to each shutter mode and the scanning mode.

However, the test pattern cannot be output in the WOI mode and Binning-WOI mode.

It is output for the random trigger shutter by the external trigger signal input.

The shutter speed, the setup, and the gain become invalid.

The FPN correction, pixel defect correction, and the step correction function, etc. become invalid.

The kind of the test pattern that can be output is as follows.

- (1) Black
- (2) White
- (3) Gray(25%) / Gray(75%)
- (4) Gray(50%)
- (5) Stripe
- (6) 16-Step
- (7) Ramp
- (8) Mix (factory setting)

The test pattern can reverse the brightness and change direction of the pattern (horizontal and vertical) (Part is excluded).

Moreover, it is possible to display it by superimposing the following enhancing patterns.

- (1) Line
- (2) Center marker
- (3) Character

9. Appended figure

9.1 External-view Drawing

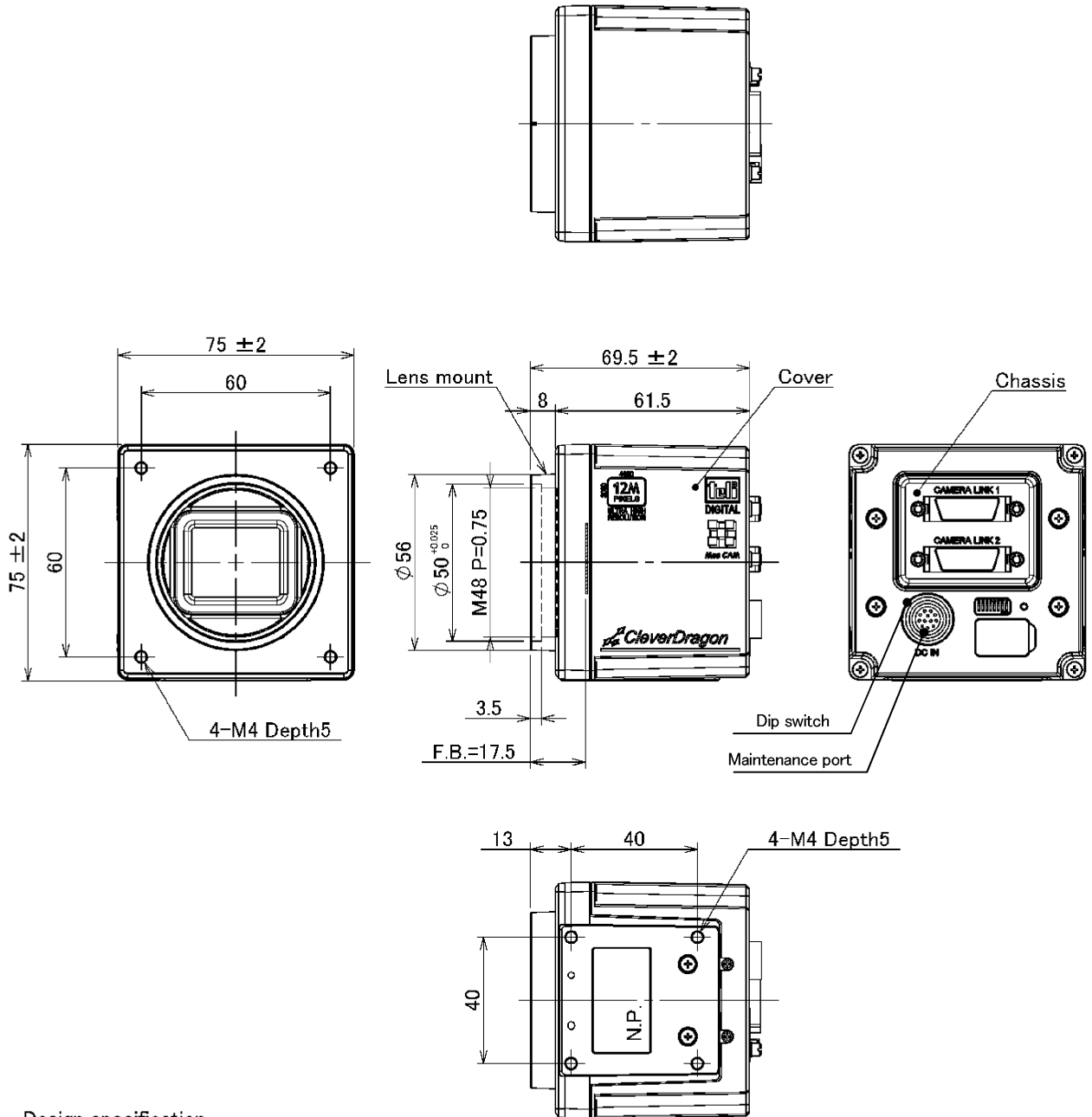

Design specification

Material

Lens mount,Cover : Aluminum die cast

Chassis : Cold-rolled steel sheet

Processing

Lens mount,Cover : Cation electro-painting(black)

Chassis : Nickel plating

9.2 Administrative Measure on the Control of Pollution Caused by Electronic Information Products  
(Popular name : China RoHS) Related information

 中华人民共和国 环保使用期限	<p>环保使用期限标识，是根据电子信息产品污染控制管理办法以及，电子信息产品污染控制标识要求(SJ/T11364-2006)、电子信息产品环保使用期限通则，制定的适用于中国境内销售的电子信息产品的标识。</p> <p>电子信息产品只要按照安全及使用说明内容，正常使用情况下，从生产月期算起，在此期限内，产品中含有的有毒有害物质不致发生外泄或突变，不致对环境造成严重污染或对其人身、财产造成严重损害。</p> <p>产品正常使用后，要废弃在环保使用年限内或者刚到年限的产品时，请根据国家标准采取适当的方法进行处置。</p> <p>另外，此期限不同于质量/功能的保证期限。</p> <p>The Mark and Information are applicable for People's Republic of China only.</p>
--	--

<产品中有毒有害物质或元素的名称及含量>

部件名称	有毒有害物质或元素					
	铅 (Pb)	汞 (Hg)	镉 (Cd)	六价铬 (Cr(VI))	多溴联苯 (PBB)	多溴二苯醚 (PBDE)
相机本体	×	○	○	○	○	○



○：表示该有毒有害物质在该部件所有均质材料中的含量均在电子信息产品中有毒有害物质的限量要求标准规定的限量要求(SJ/T11363-2006)以下  
 ×：表示该有毒有害物质至少在该部件的某一均质材料中的含量超出电子信息产品中有毒有害物质的限量要求标准规定的限量要求(SJ/T11363-2006)

This information is applicable for People's Republic of China only.

リサイクルに関する情報 (包装物)

有关再利用的信息(包装物)

Information on recycling of wrapping composition

<p>箱／箱子／Box</p>  <p>段ボール 瓦楞纸板 Corrugated cardboard</p>	<p>内部緩衝材料・袋 内部缓冲材料・袋 Internal buffer materials・</p>  <p>LDPE</p>
---	--

## 10. Warranty

The term of a warranty is one year after the product delivery.

If by any chance trouble by responsibility of our company occurs before an above period, TELI repairs it free of charge.

- During terms of a guarantee, when the trouble cause is the case of below, TELI charges the repair costs.

- (1) Troubles and the damages that causes by misuse, unsuitable repair or remodeling.
- (2) Distribution hazards like drops and vibrations after purchase. Troubles and damages by transportation.
- (3) Troubles and damages by fire, natural calamity (earthquake, storm and flood damage, thunderbolt), damages from salty breeze, gas harm, abnormal voltage.

## 11. Repair

Condition for repair

Basically, has to return it to our company when the user requests us to repair product.

Beside that, customer should pay these expenses (travel expenses, camera disassembly technology costs) of both customer and end user. Also customer should pay in themselves costs for return camera to us.

The period of repairing product

- (1) Repair free of charge ... Refer to Clause 10.
- (2) Charged repair ..... Basically, repair period is 7 years after the last production end of products.



## **TOSHIBA TELI CORPORATION**

---

**Head Office** : 7-1, 4 chome, Asahigaoka, Hino-shi, Tokyo, 191-0065, Japan  
(International Business Department)

Phone : +81-42-589-8771

Fax : +81-42-589-8774

URL : <http://www.toshiba-teli.co.jp/>

---

<b>Distributor</b>
--------------------

- This product must be classified for disposal according to the laws of each country and municipal laws.
  - Information contained in this document is subject to change without prior notice.
-