



# High-Resolution CCD B/W Camera

## MODEL CS3970CL

### Specifications

#### Contents

1. Overview .....	1
2. Features .....	1
3. Configuration .....	1
4. Optional parts .....	2
5. Specifications .....	2
6. Serial control .....	9
7. Explanation of operation .....	10
8. Outline Drawing.....	14
9. Cases for indemnity (Limited warranty) .....	15
10. Restriction for use .....	15

**TOSHIBA TELI CORPORATION**

Printed on recycled paper

D4134165A

## **1. Overview**

This CCD B/W camera is a high-resolution camera that features all pixel readout mode 1/1.8 CCD.

## **2. Features**

### (1) High resolution

High pixel density CCD (number of effective pixels 2.01 M, number of total pixels 2.11 M) is used.

### (2) Square grids

The CCD pixels arrayed in square grids facilitates computation for image processing.

### (3) Full-frame shutter

Since all pixels are output even by shutter operation, high resolution can be achieved, without deteriorating the vertical resolution.

### (4) Camera link interface

The interface for image output and camera control complies with the camera link standard.

By using a camera link frame grabber board for camera link, the shot image can be transferred to PC at high speed, and various camera controls can be performed from PC.

### (5) All-pixel readout mode (normal mode)

All pixel signals (in the effective area) are output in approximately 1/15 second.

### (6) Partial scan mode

Partial scanning of 552 lines in the center of the screen is possible.

### (7) High-speed draft readout mode

By reading 2 lines from every 8 lines, all signals in the effective area are output in approximately in 1/48 second.

### (8) Random trigger shutter

By external trigger signal input, the shot image can be grabbed at an arbitrary timing.

### (9) Multiple-shutter

By external trigger signal input, the shot image can be grabbed at an arbitrary timing and the accumulated shot images can be output at an arbitrary timing.

## **3. Configuration**

- (1) Camera body..... 1
- (2) Accessories
  - Instruction Manual (Japanese)..... 1
  - Instruction Manual (English) ..... 1

## 4. Optional parts

- |                         |                                |
|-------------------------|--------------------------------|
| (1) Power cable         | Model name: CPRC3700-**        |
| (2) Camera Link cable   | Model name: 14B26-SZLB-***-0LC |
| (3) Camera adapter      | Model name: CA170              |
| (4) Camera mounting kit | Model name: CPT4000CL          |

\*NOTE: Application software is not supplied as a standard item.

### Notes on optional parts and compliance with safety standard conditions:

We assure the compliance of this camera with the safety standard when it is used in combination with the optional parts listed above.

If you use the camera in combination with parts other than specified by our company, you are responsible for finally confirming the compliance with the safety standard by using the entire machine/equipment.

## 5. Specifications

### [Electrical specification]

- |                                  |  |
|----------------------------------|--|
| (1) Imager                       | Interline CCD  |
| • Number of total pixels         | 1688 (H) x 1248 (V)  |
| • Number of effective pixels     | 1628 (H) x 1236 (V)  |
| • Pixel size                     | 4.4 $\mu$ m (H) x 4.4 $\mu$ m (V)  |
| • Optical size                   | 1/1.8 type   |
| (2) Scan method                  | Progressive  |
| (3) Aspect ratio                 | 4:3  |
| (4) Synchronization method       | Internal synchronization   |
| (5) Standard subject illuminance | 400 lx, F8, 3000 K   |
| (6) Minimum subject illuminance  | 2 lx (F1.4, GAIN MAX, all pixel readout, video level 50 %)                       |
| (7) Video output                 | Compliant with the camera link standard.   |
| • Data                           | 12 / 10 / 8 bit switching  |
| • Readout mode                   |  |
| All pixel readout                | Approximately 15 fps / 1628(H) x 1236(V)   |
| Partial scan                     | Approximately 30 fps / 1628(H) x 552(V)  |
| High-speed draft readout         | Approximately 48 fps / 1628(H) x 309(V)  |
| (8) Gain                         | 0 to +12 dB (512 levels) (initial factory setting: 0 dB)                         |
| (9) Setup                        | 88 to 272 LSB (32 levels) (initial factory setting: 264 LSB (calculated value) ) |
| (10) Gamma correction            | OFF( $\gamma = 1.0$ ) fixed  |
| (11) Power supply voltage        | DC12 V $\pm$ 10% (ripple 50 mV(p-p) or less)                                     |
| (12) Power consumption           | Approximately 2.8 W  |

**[Electronic shutter specification]**

- |                            |   |
|----------------------------|---|
| (1) Shutter speed          |   |
| • Readout mode             |   |
| All pixel readout          | 1/15 to 1/35000 s (1250 levels)                         |
| Partial scan               | 1/30 to 1/35000 s (625 levels)                          |
| High-speed draft readout   | 1/48 to 1/35000 s (313 levels)                          |
| (2) Random trigger shutter | ON/OFF switching (initial factory setting: OFF)         |
| • Fixed mode               | The exposure time depends on the shutter speed setting. |
| • Pulse width mode         | The exposure time depends on the pulse width.           |
| (3) Multiple-shutter       | ON/OFF switching (initial factory setting: OFF)         |
|                            | Exposure by TRIG input, readout by MULTI input          |
|                            | * Enabled when random trigger shutter is ON.            |

**[Internal sync signal specification]**

- |                          |                        |
|--------------------------|------------------------|
| (1) Driving frequency    | 36.000 MHz             |
| (2) Scanning frequency   |                        |
| • Readout mode           |                        |
| All pixel readout        | Horizontal :18.750 kHz |
|                          | Vertical :15.000 Hz    |
| Partial scan             | Horizontal :18.750 kHz |
|                          | Vertical :30.000 Hz    |
| High-speed draft readout | Horizontal :15.000 kHz |
|                          | Vertical :47.293 Hz    |

**[Input signal specification]**

- |                              |   |
|------------------------------|---|
| (1) TRIG                     | Camera link I/F and DC IN connector input   |
| • Signal level (DC IN input) | TTL level   |
| • Polarity                   | Positive/Negative polarity switching possible (initial factory setting: Negative) |
| • Pulse width                | 53.3 $\mu$ s or more  |
| (2) MULTI                    | Camera link I/F input   |
| • Polarity                   | Negative polarity   |
| • Pulse width                | 53.3 $\mu$ s to 10 ms   |

**[Output signal specification]**

- |                |                            |
|----------------|----------------------------|
| (1) WEN        | DC IN connector output     |
| • Signal level | 4 V (p-p)                  |
| • Polarity     | Positive polarity          |
| • Pulse width  | Approximately 53.3 $\mu$ s |

**[Dimensions]**

- |  |  |
|--|--|
| (1) Lens mount                               | C-mount<br>*Depending on the lens you use, the performance of the camera may not be brought out fully due to the deterioration in resolution and brightness in the peripheral area, occurrence of a ghost, aberration and others.<br>When you check the combination between the lens and camera, be sure to use the lens you actually use. |
| (2) Flange back                              | 17.526 mm  |
| (3) Dimensions                               | 54 mm (W) x 43 mm (H) x 59 mm (D)  |
| (4) Mass                                     | Approximately 150 g  |
| (5) Camera body grounding: insulation status | Conductive between circuit GND and camera body   |

**[Operating ambient conditions]**

- |                           |  |
|---------------------------|--|
| (1) Performance assurance | Temperature : 0 to 40°C<br>Humidity : 10 to 90% (no condensation)    |
| (2) Operating assurance   | Temperature : -5 to 45°C<br>Humidity : 90% or less (no condensation) |

**[Typical spectral response]**

The lens characteristics and light source characteristics is not reflected in table.

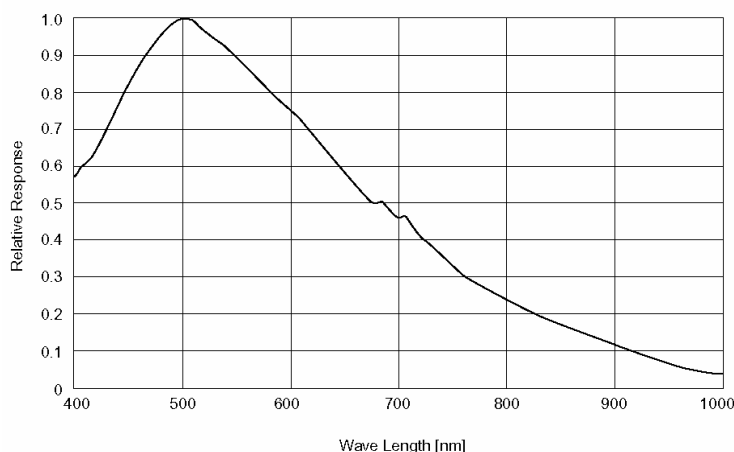
**[Applicable safety standards]**

- |  |                                 |
|--|---------------------------------|
| (1) EMC (Electro-Magnetic Compatibility) |                                 |
| EMI (Electro-Magnetic Interference)      | : EN61000-6-4 / 2001            |
| EMS (Electro-Magnetic Susceptibility)    | : EN61000-6-2 / 2001            |
| (2) FCC                                  | : FCC Part 15 Subpart B class A |

**[Communication specification]**

(1) Communication speed	9600/19200/38400 bps
(2) Data bit	None
(3) Parity	8
(4) Stop bit	1
(5) Parity bit	None
(6) Handshake	None

**[Connector pin assignment]**

(1) Video output/controlling connector (Camera Link Base Configuration) CAMERA LINK

• Connector model : MDR 26-PIN connector 10226-2210VE (manufactured by 3M).

Pin No.	I/O	Signal Name	Pin No.	I/O	Signal Name
1	-	GND	14	-	GND
2	O	Tx OUT0-	15	O	Tx OUT0+
3	O	Tx OUT1-	16	O	Tx OUT1+
4	O	Tx OUT2-	17	O	Tx OUT2+
5	O	Tx CLK OUT-	18	O	Tx CLK OUT+
6	O	Tx OUT3-	19	O	Tx OUT3+
7	I	Ser TC (RxD) +	20	I	Ser TC (RxD) -
8	O	Ser TFG (TxD) -	21	O	Ser TFG (TxD) +
9	I	CC1 (TRIG) -	22	I	CC1 (TRIG) +
10	I	CC2 (MULTI) +	23	I	CC2 (MULTI) -
11	I	CC3-	24	I	CC3+
12	I	CC4+	25	I	CC4-
13	-	GND	26	-	GND

(2) Connector for power supply and sync signal input/output DC IN

• Connector (Camera side) : HR10A-10R-12PB (Manufactured by HIROSE DENKI)

• Plug (Cable side) : HR10A-10P-12S (Manufactured by HIROSE DENKI) or equivalents

Pin No.	I/O	Signal Name
1	-	GND
2	I	+12V
3	-	N.C.
4	-	N.C.
5	-	GND
6	-	N.C.
7	-	N.C.
8	-	GND
9	-	N.C.
10	O	WEN
11	I	TRIG
12	-	GND

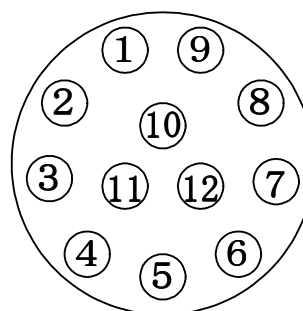

Rearview

[Switch setting]

By using the DIP switches on the back surface of the camera body, you can set serial transmission speed and memory readout for when the power supply is turned on.

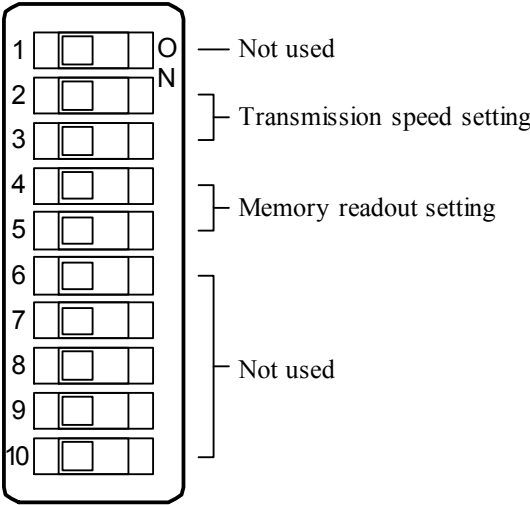

(1) Transmission speed setting

You can set the speed of serial transmission by camera link.

SW2	SW3	Transmission speed
OFF	OFF	9600 bps
ON	OFF	19200 bps
OFF	ON	38400 bps

(2) Memory readout setting

You can set the number of the setting value saving memory bank to be called when the power supply is turned on. The memory consists of 4 banks.

SW4	SW5	Memory number
OFF	OFF	0
ON	OFF	1
OFF	ON	2
ON	ON	3

[Timing chart]

(1) Horizontal timing

1) All pixel readout, Partial scan

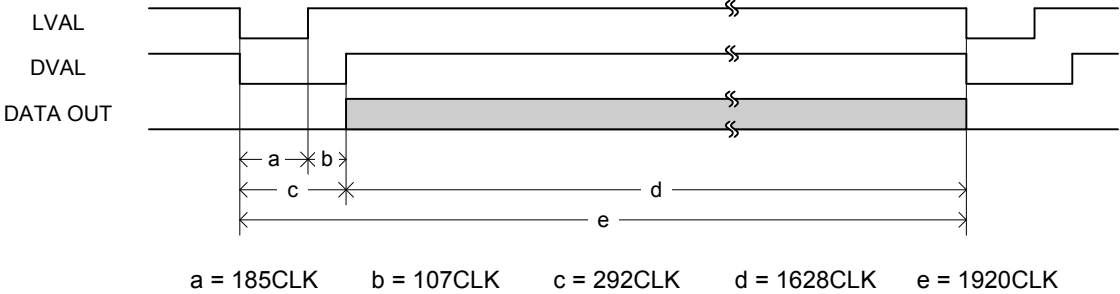

2) High-speed draft readout

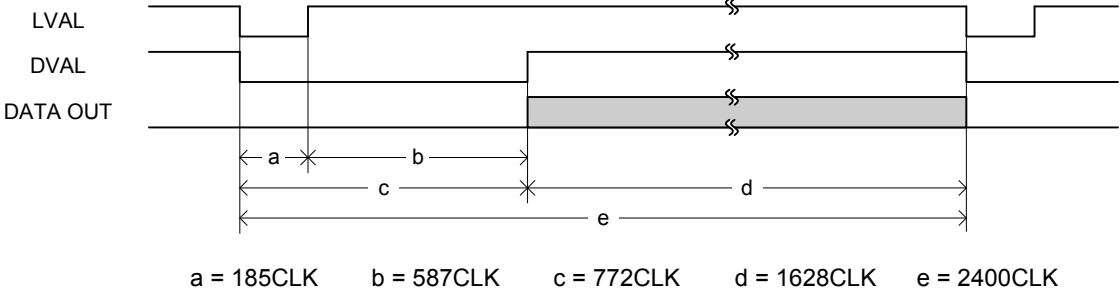

(2) Vertical timing

1) All pixel readout

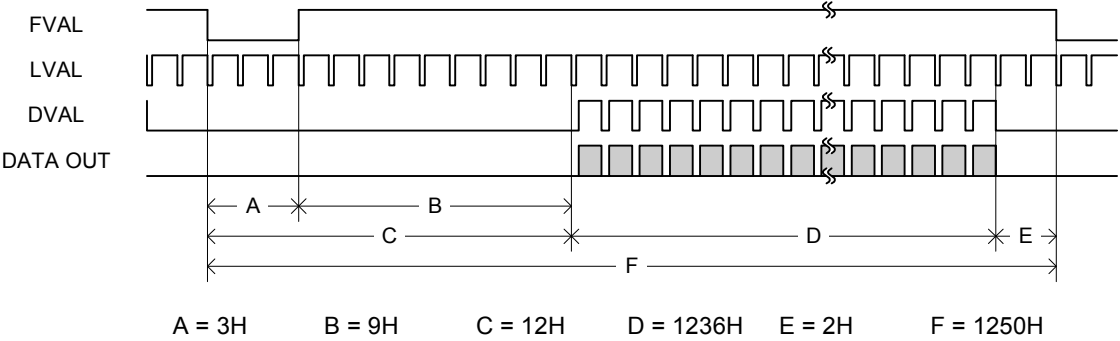

2) Partial scan

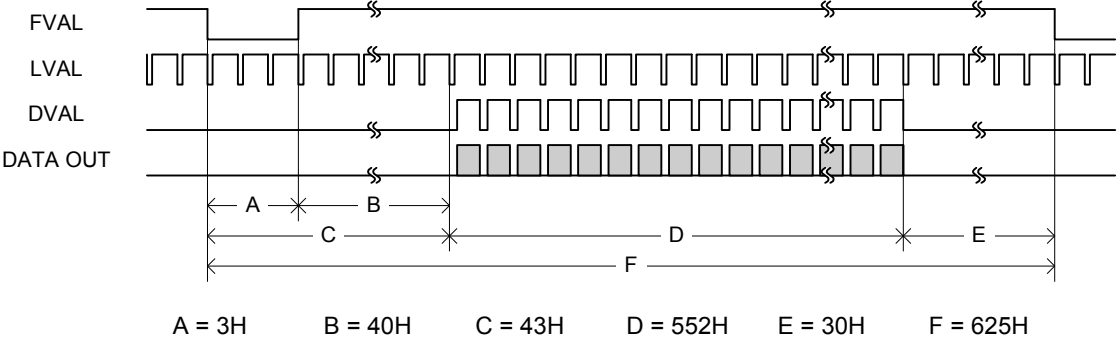

3) High-speed draft readout

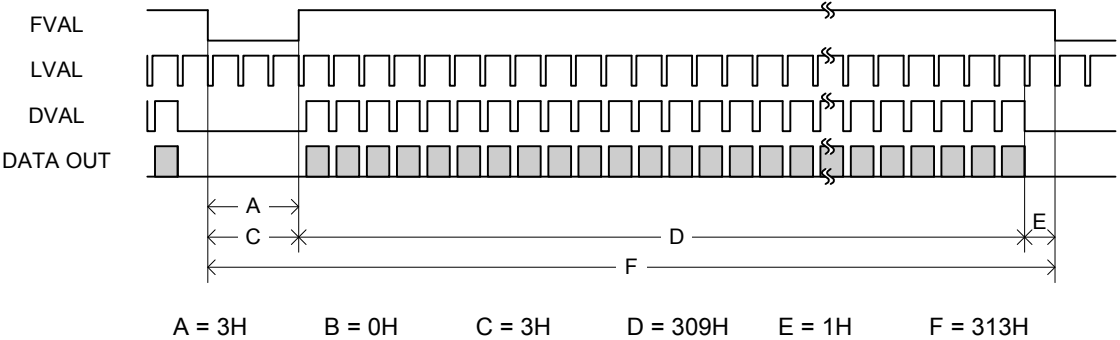



# 7. Explanation of operation

## 7.1 Readout mode

Video is output from the camera link connector. The output video can be grabbed by the frame grabber board. The frame rate and resolution of output images that this model supports are as follows:

- 1) All pixel readout : Approximately 15 fps / 1628(H) x 1236(V)
- 2) Partial scan : Approximately 30 fps / 1628(H) x 552(V)
- 3) High-speed draft readout : Approximately 48 fps / 1628(H) x 309(V)

### 1) All pixel readout

Reads out all pixels in about 1/15 second.

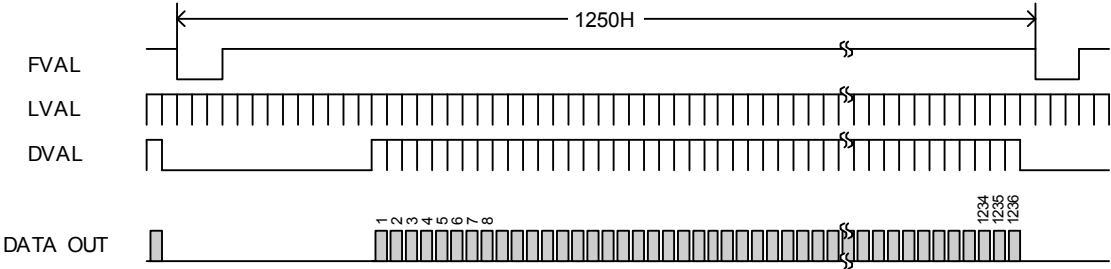

2) Partial scan

Skips the top and bottom of the effective area and reads out 552 lines in the center area in approximately 1/30 second.

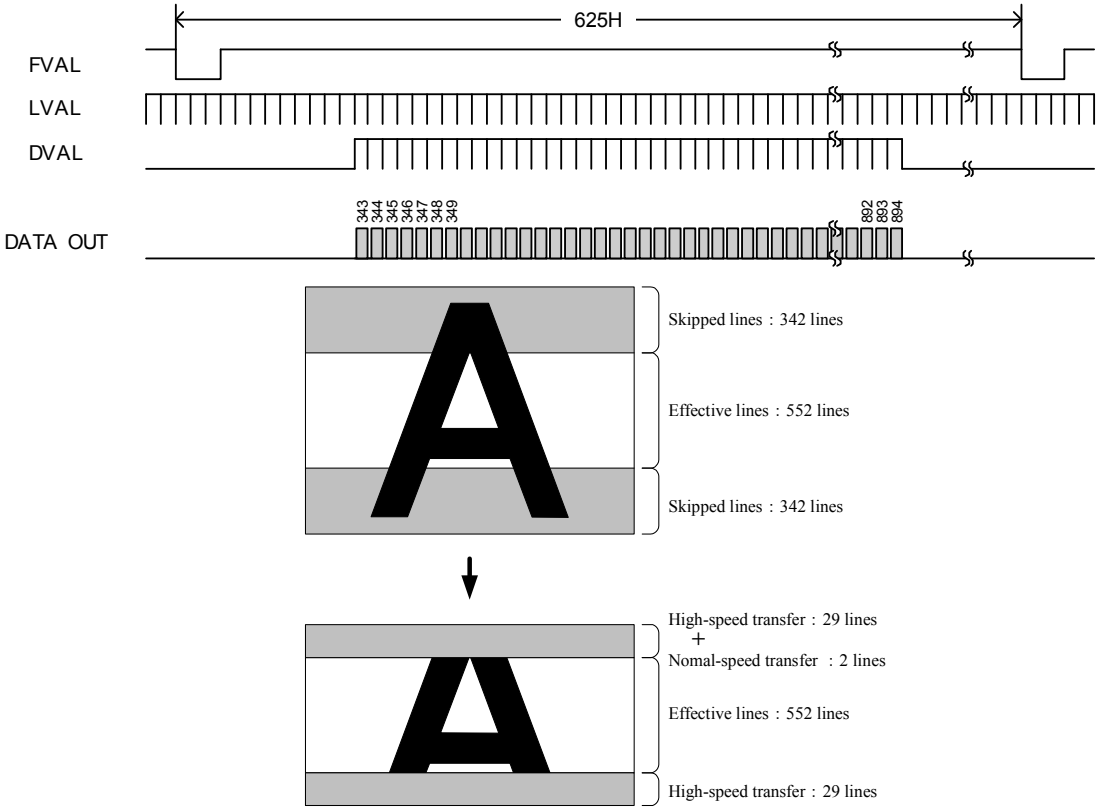

3) High-speed draft readout

By reading 2 lines out of every 8 lines, reads out the whole valid area in approximately 1/48 seconds.

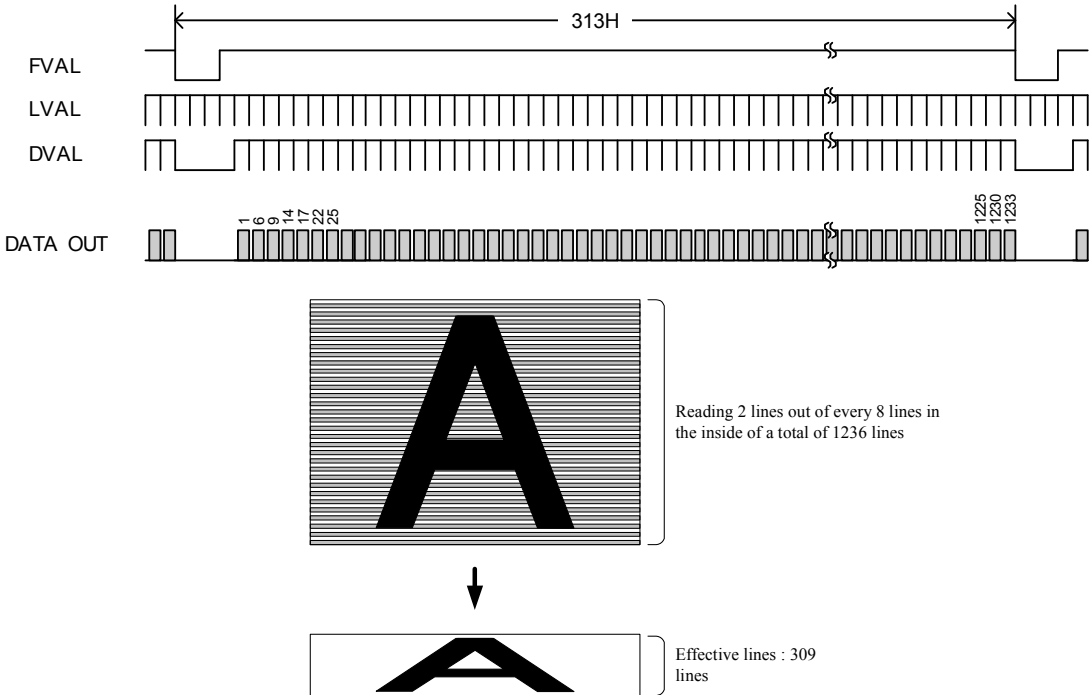

### 7.2 Random trigger shutter

In the random trigger shutter mode, you can shoot and grab an image at an arbitrary timing by trigger signal input from the external.

- External trigger signals can be input either from the camera link I/F CC1 or DC IN connector.
- If polarity is set to negative polarity, exposure starts at the falling edge of the trigger.
- The random trigger shutter of this camera can be operated in two types of mode: fixed mode and pulse width mode. How to determine the exposure time differs depending on the mode.

#### 1) Fixed mode

- The exposure time is determined by the setting value for the shutter speed.
- FVAL is output in sync with the first LVAL after the end of exposure time.

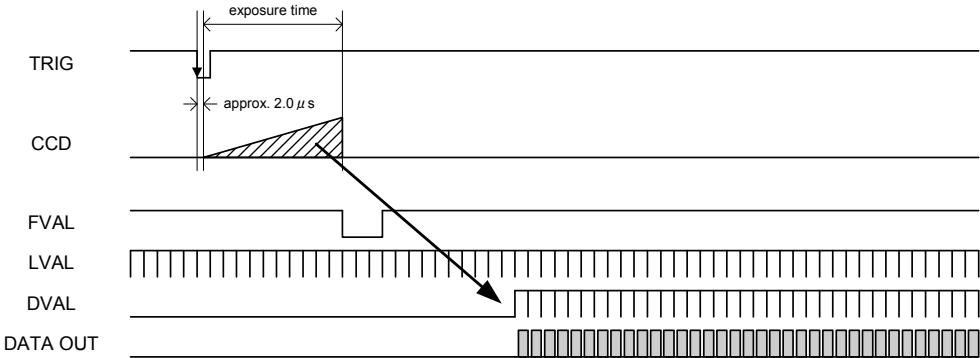

#### 2) Pulse width mode

- The exposure time is determined by the pulse width (exposure time = pulse width + approximately 28 μs).
- Set a pulse width of 1H (approximately 53.3 μs) or more.
- FVAL is output in sync with the first LVAL after the end of exposure time.

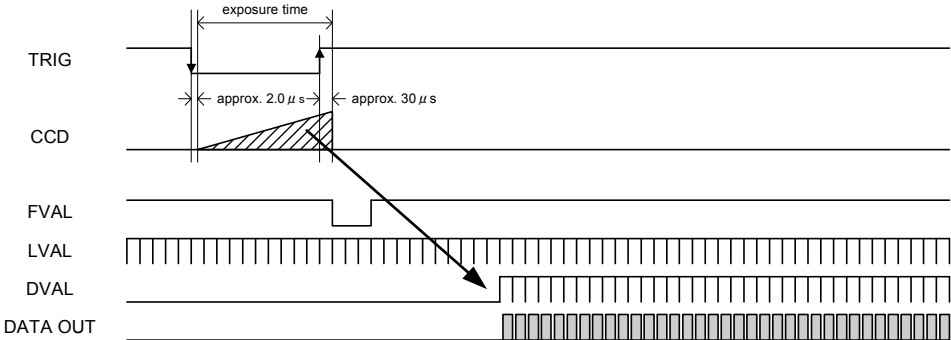

7.3 Multiple-shutter mode

In the multiple-shutter mode, video is output in sync with a MULTI signal from the external after the end of exposure time.

- Valid only when the random trigger shutter mode is ON.
- MULTI signals can be input from the camera link I/F CC2.
- If exposure is executed several times before MULTI signal input, the images are output superposed.
- The exposure time is determined by the random trigger shutter mode setting and its determination method.
- The pulse width must be set to negative polarity and 1H (approximately 53.3  $\mu$  s) to 10 ms.
- FVAL is output in sync with the first LVAL after the end of MULTI signal input.

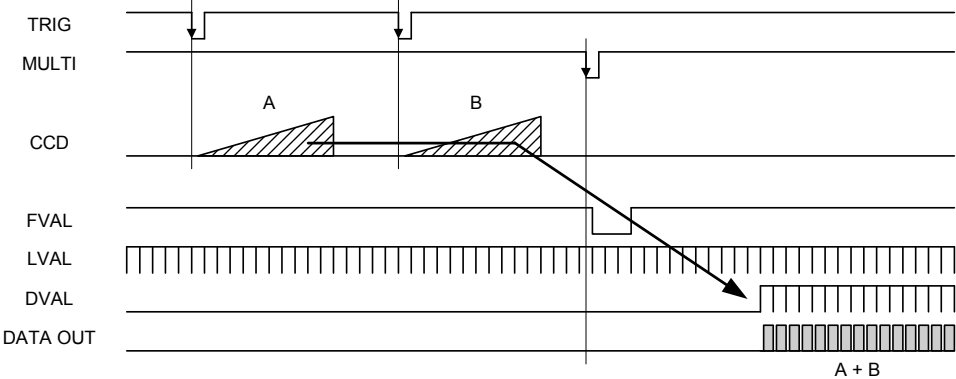

**8. Outline Drawing**

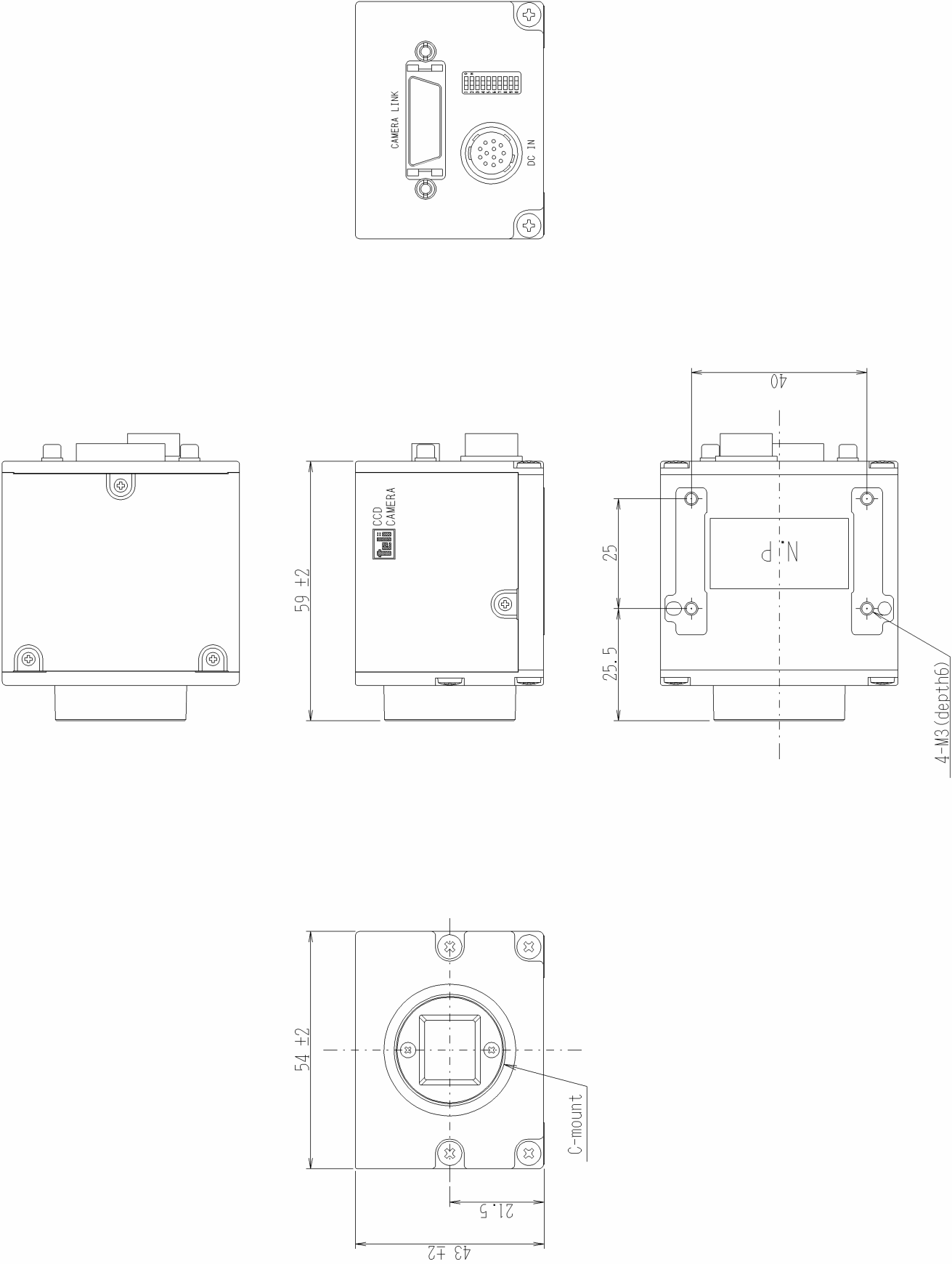

## **9. Cases for indemnity (Limited warranty)**

We shall be exempted from taking responsibility and held harmless for damage or losses incurred by the user in the following cases

- In the case damage or losses are caused by fire, earthquake, or other acts of God, acts by a third party, deliberate or accidental misuse by the user, or use under extreme operating conditions.
- In the case of indirect, additional, consequential damages (loss of business interests, suspension of business activities) are incurred as result of malfunction or non-function of the equipment, we shall be exempted from responsibility for such damages.
- In the case damage or losses are caused by failure to observe the information contained in the instructions in this instruction manual and specifications.
- In the case damage or losses are caused by use contrary to the instructions in this instruction manual and specifications.
- In the case damage or losses are caused by malfunction or other problems resulting from use of equipment or software that is not specified.
- In the case damage or losses are caused by repair or modification conducted by the customer or any unauthorized third party (such as an unauthorized service representative).
- Expenses we bear on this product shall be limited to the individual price of the product.

## **10. Restriction for use**

- Should the equipment be used in the following conditions or environments, give consideration to safety measures and inform us of such usage:
  1. Use of the equipment in the conditions or environment contrary to those specified, or use outdoors.
  2. Use of the equipment in applications expected to cause potential hazard to people or property, which require special safety measures to be adopted.
- This product can be used under diverse operating conditions. Determination of applicability of equipment or devices concerned shall be determined after analysis or testing as necessary by the designer of such equipment or devices, or personnel related to the specifications. Such designer or personnel shall assure the performance and safety of the equipment or devices.
- This product is not designed or manufactured to be used for control of equipment directly concerned with human life (\*1) or equipment relating to maintenance of public services/functions involving factors of safety (\*2). Therefore, the product shall not be used for such applications.
  - (\*1): Equipment directly concerned with human life refers to.
    - Medical equipment such as life-support systems, equipment for operating theaters.
    - Exhaust control equipment for exhaust gases such as toxic fumes or smoke.
    - Equipment mandatory to be installed by various laws and regulations such as the Fire Act or Building Standard Law
    - Equipment related to the above
  - (\*2) :Equipment relating to maintenance of public services/functions involving factors of safety refers to.
    - Traffic control systems for air transportation, railways, roads, or marine transportation
    - Equipment for nuclear power generation
    - Equipment related to the above



## **TOSHIBA TELI CORPORATION**

---

**Head Office:** 7-1, 4 chome, Asahigaoka, Hino-shi, Tokyo, 191-0065, Japan  
(Overseas Sales Department)

Phone : +81-42-589-8771

Fax : +81-42-589-8774

URL : <http://www.toshiba-teli.co.jp>

---

**Distributor**

- This product must be classified for disposal according to the laws of each country and municipal laws.
  - Information contained in this document is subject to change without prior notice.
-