



B/W CCD Camera

Model CS8550Di

Specifications

Contents

1. Product Description	2
2. Features.....	2
3. Configuration.....	3
4. Option Unit.....	3
5. Operation Mode	3
6. Specifications	19
7. Timing Chart	26
8. External View Drawing	32

TOSHIBA TELI CORPORATION

1. PRODUCT DESCRIPTION

Model CS8550Di is an integrated type B/W CCD camera with a VGA format all-pixel-data readout CCD. This model has twice greater driving frequency of conventional cameras to achieve fast-speed data-processing. The model is suited for high-speed, high-resolution image processing use. Its compact, light-weight body is ideal for system integration.

2. FEATURES

(1) Double-speed scan

This model reads out image-data twice as fast as conventional cameras do.

(2) All pixel's data readout

With its built-in all-pixel-data-readout CCD, this model can read out image-data just in approximately 1/60 sec. A frame-shutter reads out all data even under RTS (Random Trigger Shutter) mode.

(3) High vertical resolution

As all pixel's data are read out even under RTS mode (in 1/60 sec.), images with no deterioration in vertical resolution are obtained.

(4) Square grid pattern CCD

Pixel's in CCD are aligned in square grid pattern. This makes it easier to perform computation correctly for image processing use.

(5) External Sync.

The camera is switched over to external synchronization operation automatically when external HD signal is input.

(6) Random trigger shutter function

With a built-in RTS, the camera's CCD starts light-exposure in synchronization with external trigger signals. This function enables the camera to capture fast-moving subjects at constant position for precise image processing.

(7) Restart / Reset

Under the restart / reset mode, this model can capture images at an arbitrary timing cued by external VD signal.

(8) Multiple shutter

With this shutter, this model capture images at an arbitrary timing cued by external trigger signal, and then outputs video at an arbitrary timing cued by external VD signal.

(9) Partial-scan

Under the partial scan mode, only 1/2 or 1/4 screen center portion of image information is read out, resulting in a faster operation.

(10) Ultra-compact & light-weight camera head

The model features its ultra-compact and light-weight camera head, freeing you from your integration-space-problem. In addition, it has an excellent shock and vibration resistance.

3. CONFIGURATION

- (1) Camera body..... 1
- (2) Accessory
 - Operation Manual(Japanese) 1
 - Operation Manual(English) 1

4. OPTION UNIT

- (1) DC SYNC IN cable
- (2) Camera adapter
- (3) Camera-mounting kit
- (4) Camera-connector fixing hardware
 - *Contact your dealer / distributor for details of option units.

5. OPERATION MODE

- (1) GAIN selection (Camera rear-panel SW)
 - Switches sensitivity setting
 - (1-1) FIX ----- Factory-prefixed gain
 - (1-2) MANU ----- Gain is adjustable via the manual gain potentiometer (M.GAIN)
- (2) Video output mode selection (Camera rear-panel DIP SW)
 - Switches video format
 - (2-1) 1/60: 1/60s----- Non-interlace mode
 - As all pixels are read out in 1/60s, you will get images with the higher V resolution.
 - (2-2) 1/120: 1/120s----- 2:1 interlace MIX mode
 - As vertical pixels are added in readout, the sensitivity is same as that of 1/60s non-interlace mode during electronic shutter OFF.
 - Twice greater sensitivity is obtained under shutter-speed range of 1/200 – 1/20000.
- (3) TRIG selection (Camera rear-panel DIP SW)
 - Switches TRIG input signal polarity used under RTS mode
 - (3-1) POSI----- Positive polarity (rising edge detection)
 - (3-2) NEGA----- Negative polarity (falling edge detection)
- (4) RTS (Random Trigger Shutter) exposure selection (Camera rear-panel DIP SW)
 - Switches light exposure mode under RTS mode
 - (4-1) FIX mode----- Rear DIP SW
 - Exposure-time control via rear-panel DIP switch
 - (4-2) PULSE W mode---- TRIG signal pulse width control
 - Exposure-time control via TRIG signal pulse width
- (5) Shutter mode selection (Camera rear-panel DIP SW or TRIG signal IN [Automatic])
 - Switches shutter mode
 - (5-1) NOR mode ----- Normal electronic shutter
 - Exposure control via internal sync signal
 - High-speed shutter: From 1/20,000s through OFF (8 position)
 - (5-2) RTS mode ----- Random trigger shutter
 - Exposure control via ext. trigger or ext. sync input
 - Timing charts are shown below. (TRIG timing: Positive)
 - Notes: * RTS selection is automatic with TRIG status
 - ** Neither under FIX nor PULSE W mode, RTS doesn't work if Electronic shutter speed SW is set in OFF position.

(a) Non-reset mode (Under internal sync / external sync --- Consecutive VD IN)

Exposure starts at the timing of TRIG signal IN. After each exposure is completed, the camera outputs video at each next VD IN timing.

□ 1/60s Non-interlace

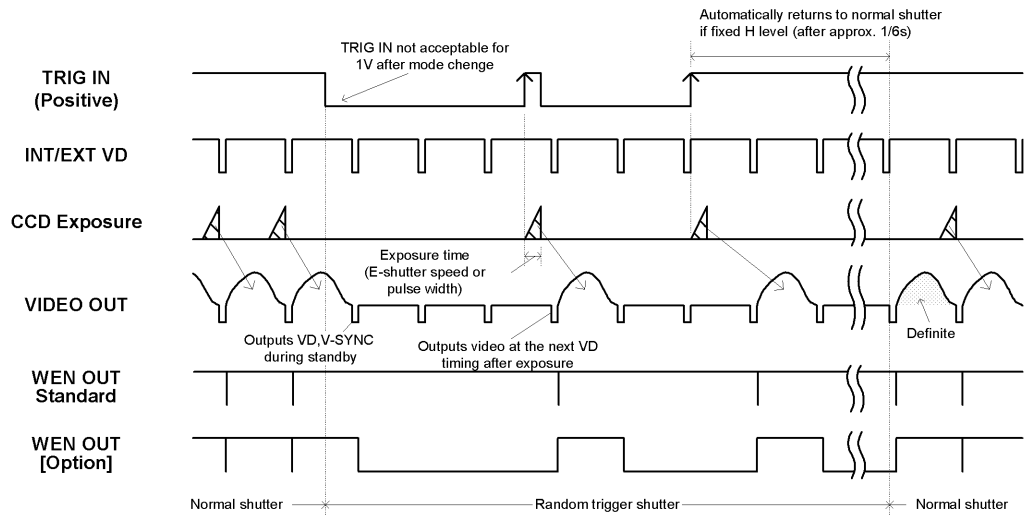

□ 1/120s 2:1 Interlace

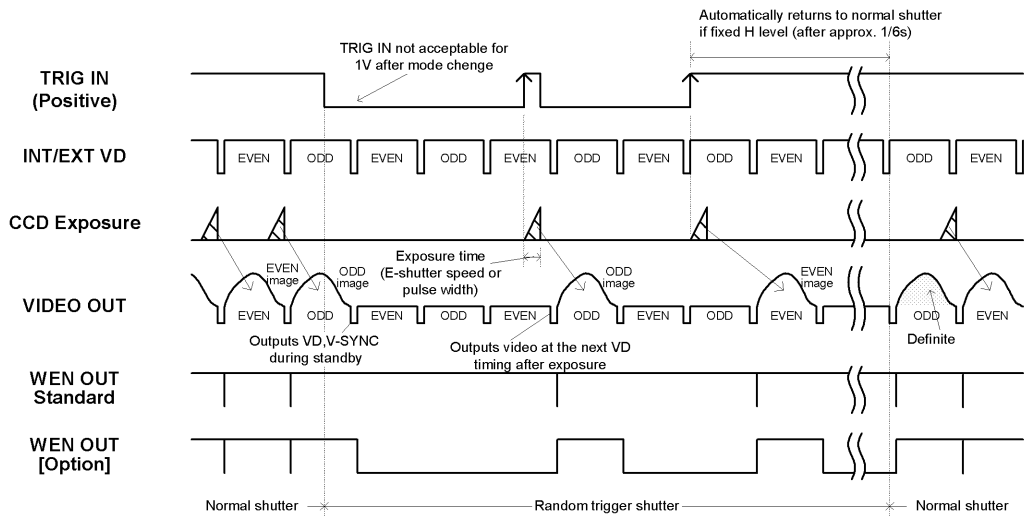

(b) Non-reset mode (Under external sync --- Single VD IN)

After TRIG IN and exposure, the camera goes into standby until next ext. VD IN.

□ 1/60s Non-interlace

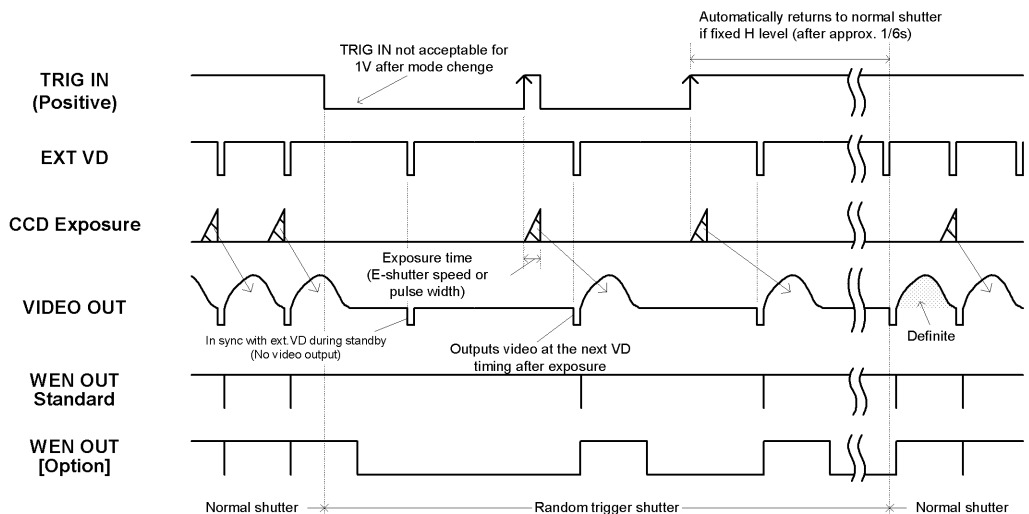

*Don't provide ext. VD IN during exposure.

** After automatic return, fix ext. VD IN at Hi.

□ 1/120s 2:1 Interlace

Video output field (ODD/EVEN) is determined by ext. VD falling edge and ext. HD phase.

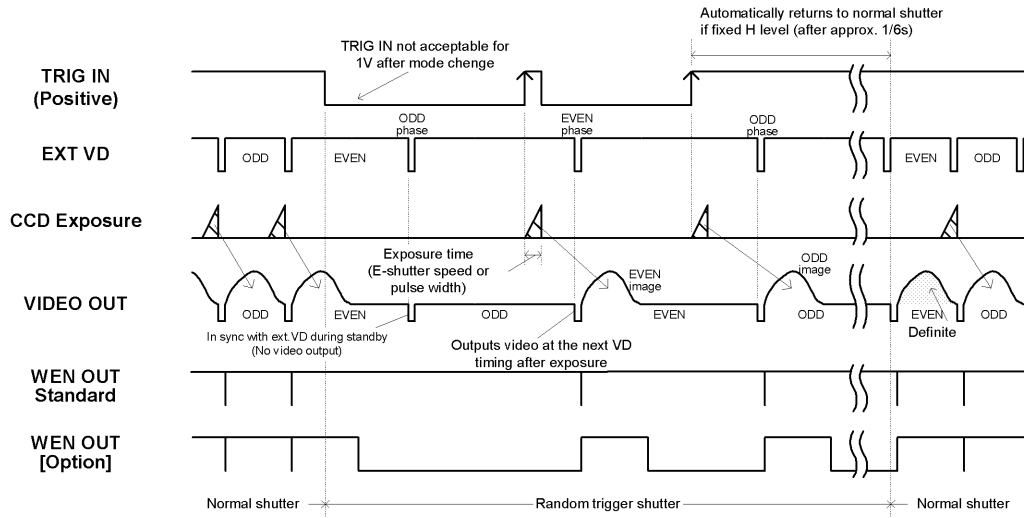

*Don't provide ext. VD IN during exposure.

** After automatic return, fix ext. VD IN at Hi.

(c) V-reset mode (Under internal sync / external sync --- No VD IN)

Exposure starts at the timing of TRIG signal IN. After each exposure is completed, the camera outputs video immediately by resetting VD. (HD is not reset)

□ 1/60s Non-interlace

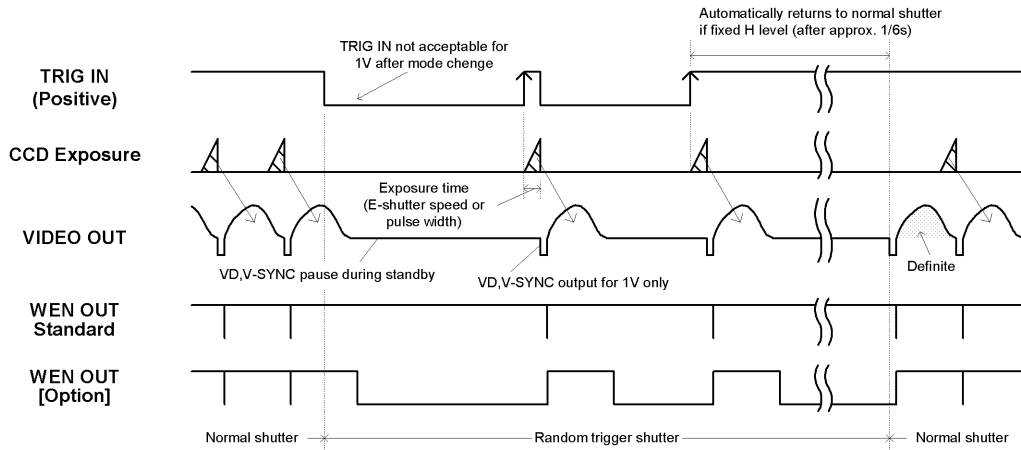

□ 1/120s 2:1 Interlace

Irrespective of TRIG IN phase, the camera always outputs ODD field image.

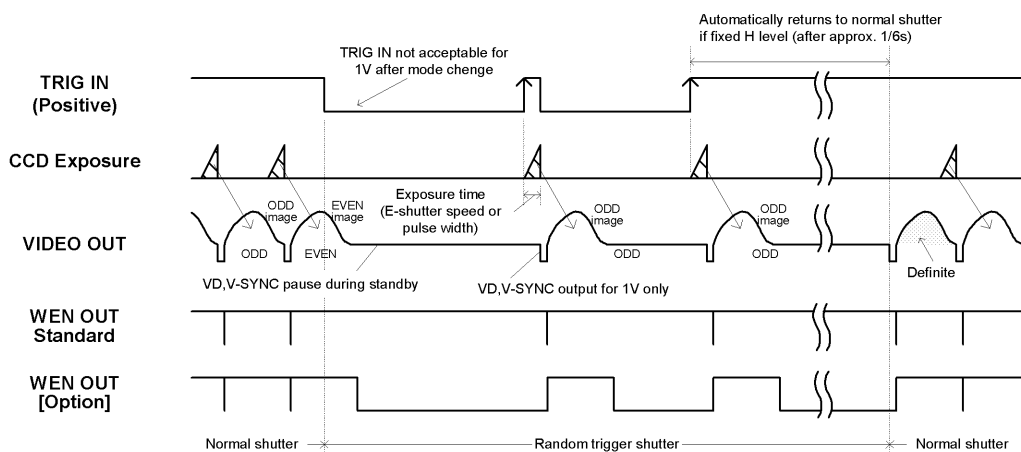

(d) SYNC reset mode (Under internal sync)

Exposure starts at TRIG signal input timing, resets HD, and outputs video immediately after exposure by resetting VD.

* Available under FIX mode only.

□ 1/60s Non-interlace

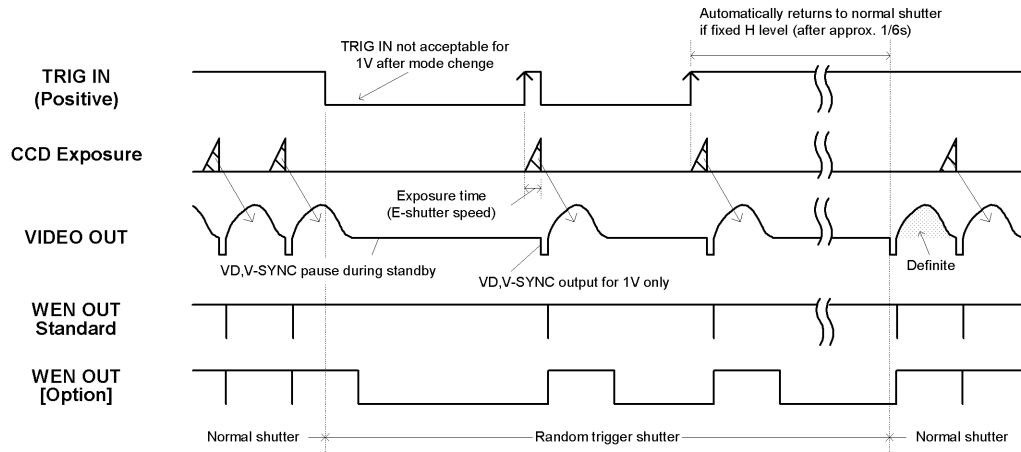

□ 1/120s 2:1 Interlace

Irrespective of TRIG IN phase, the camera always outputs ODD field image.

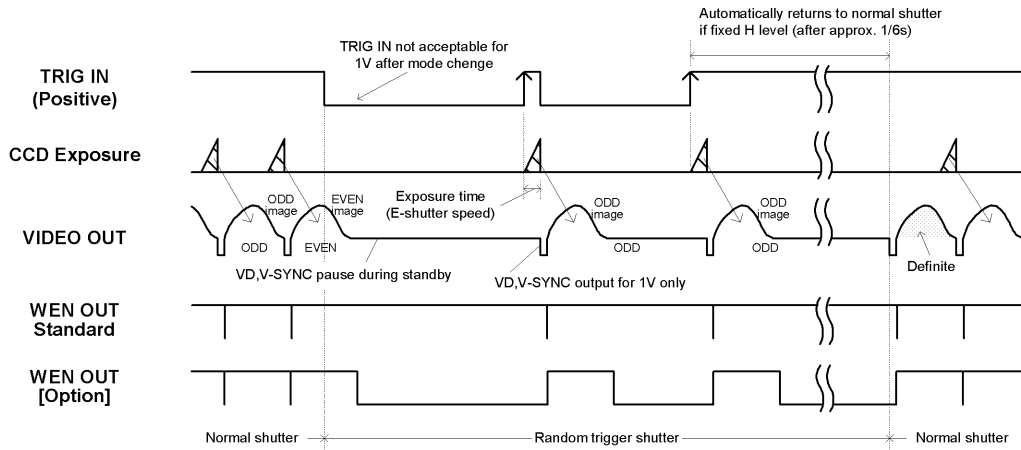

(5-3) MULTIPLE SHUTTER mode

Multiple shutter operation is available by providing TRIG IN more than one time before ext. VD IN. (Non-reset mode, single VD, consecutive VD IN)

□ 1/60s Non-interlace

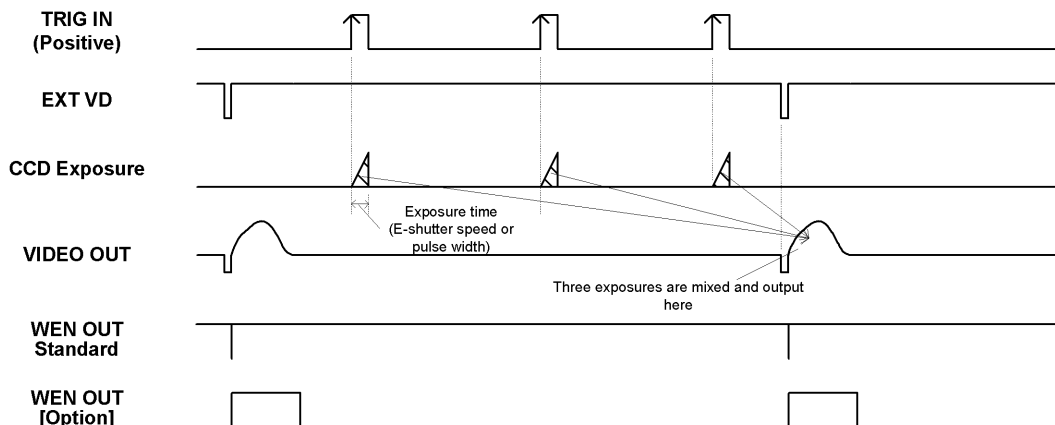

□ 1/120s 2:1 Interlace

Video output field (ODD/EVEN) is determined by ext. VD falling edge and ext. HD phase.

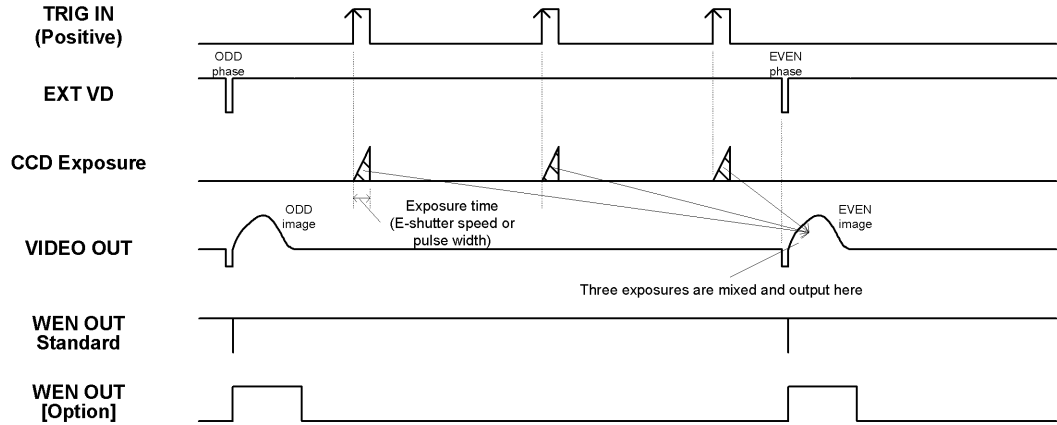

■ Exposure time delay under RTS

When the RTS is active, both in FIX mode and PULSE W mode, there is a time delay of approximately 1.4 micro s until the start of exposure after the rising edge of TRIG signal (positive).

■ Exposure time under pulse width mode

Under RTS pulse mode, the exposure time is determined by the pulse width. More exactly, the actual time is the pulse width plus approximately 19.1 micro s.

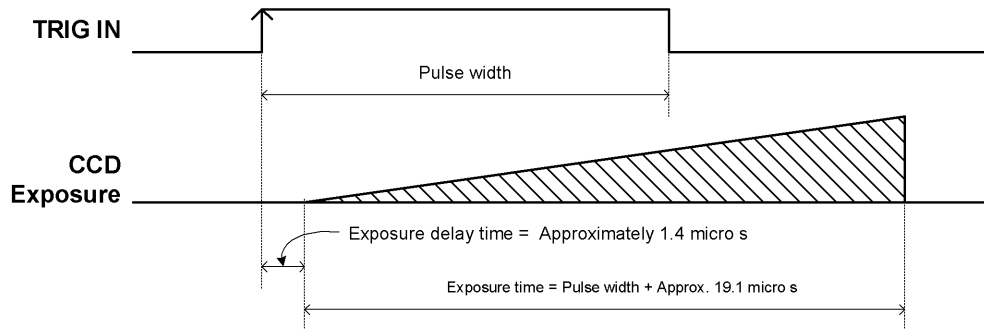

(5-4) Restart / Reset

The restart / reset function is available with the ext.VD signal. You can get an arbitrary slower shutter speed than normal shutter and random trigger shutter.

Here are some notes;

- * The shutter speed (exposure time) is determined by ext. VD signal interval.
- ** This function is enabled when the rear-panel shutter speed DIP SW is OFF.
- *** Supply consecutive HD.

1/60s Non-interlace

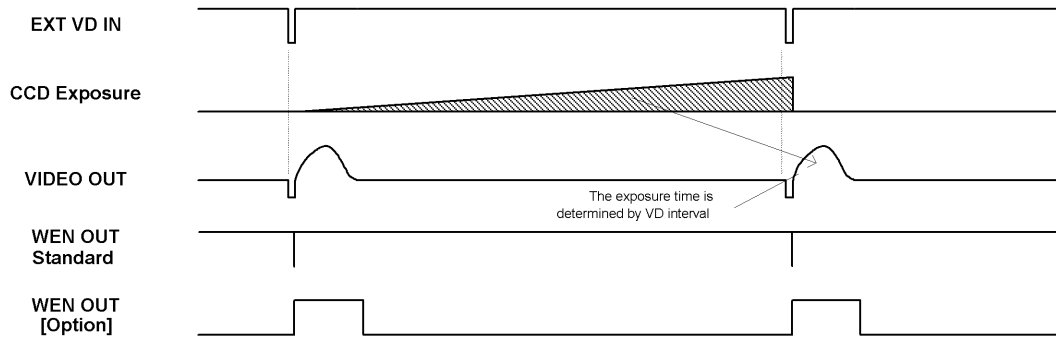

1/120s 2:1 Interlace

Video output field (ODD/EVEN) is determined by ext. VD falling edge and ext. HD phase.

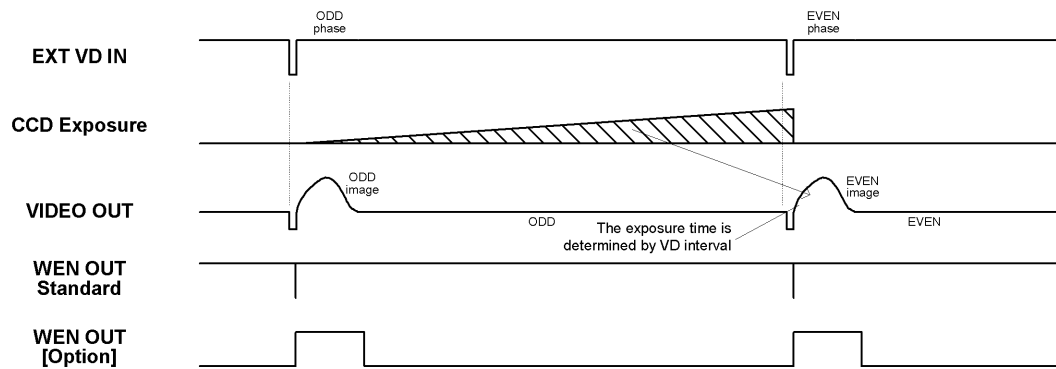

(6) Partial-scan mode selection (Camera rear-panel DIP SW)
Switches partial-scan mode

Note: Sometimes phenomenon called as “whiteout” occurs at the top of the screen when there is strong incident light entering in the wide area of a CCD, however, this is not a malfunction. If this occurs, reduce the amount of incoming rays.

(6-1) 1/2 Partial-scan (Rear-panel SW: #7-OFF, #8-ON) --- Screen center 1/2 readout

1/60s Non-interlace

Under 1/60s non-interlace mode, only the center portion of 220H out of the total effective lines 492H (excluding BLK time) is read out. Available both under external / internal mode.

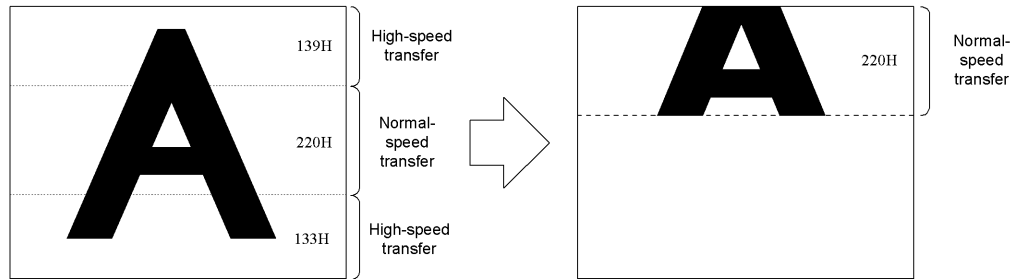

■ Under normal shutter (Electronic shutter OFF)

Notes: * Under ext. sync, the ext. VD should be 1V = 262H.

** Under normal shutter, set the rear-panel DIP SW #5, #6 in OFF.

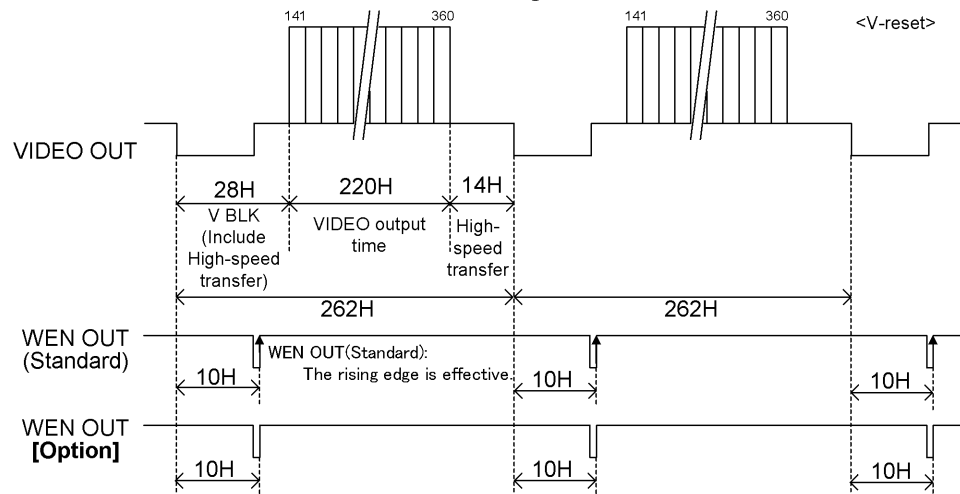

■ Under other shutter modes

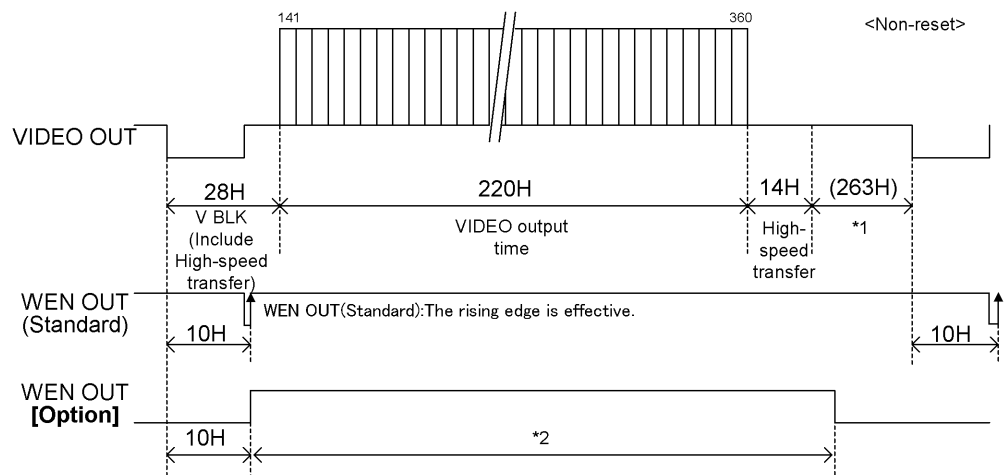

*1:Arbitrary under ext.sync

*2:See "7.TIMING CHART (4)WEN timing".

□ 1/120s 2:1 Interlace

Under 1/120s interlace mode, only the center portion of 207H out of the total effective lines 485H (excluding BLK time) is read out. Available both under external / internal mode.

ODD Field

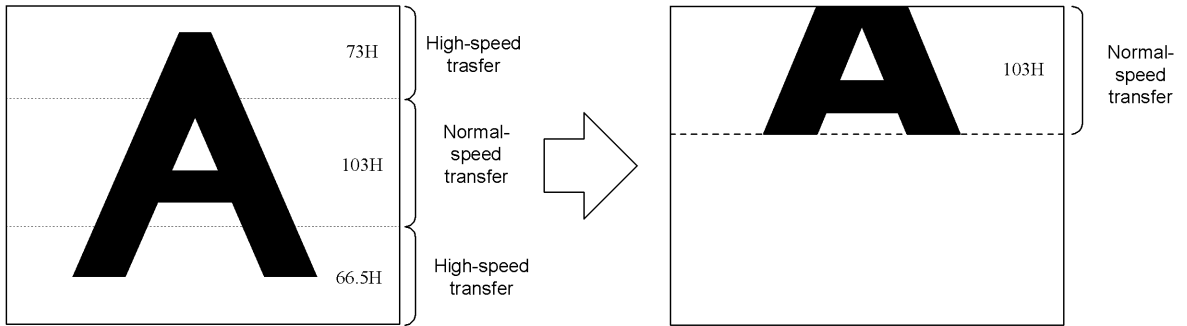

EVEN Field

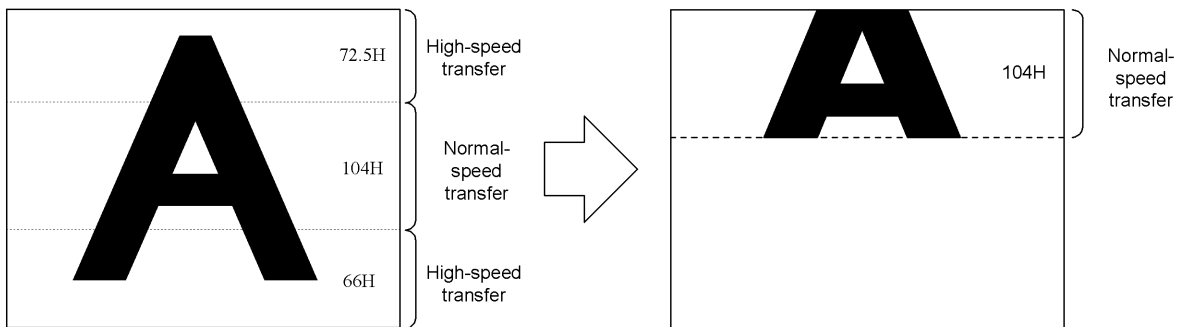

■ Under normal shutter (Electronic shutter OFF)

Notes: * Under ext. sync, the ext. VD should be $1V = 131.5H$.

** Under normal shutter, set the rear-panel DIP SW #5, #6 in OFF.

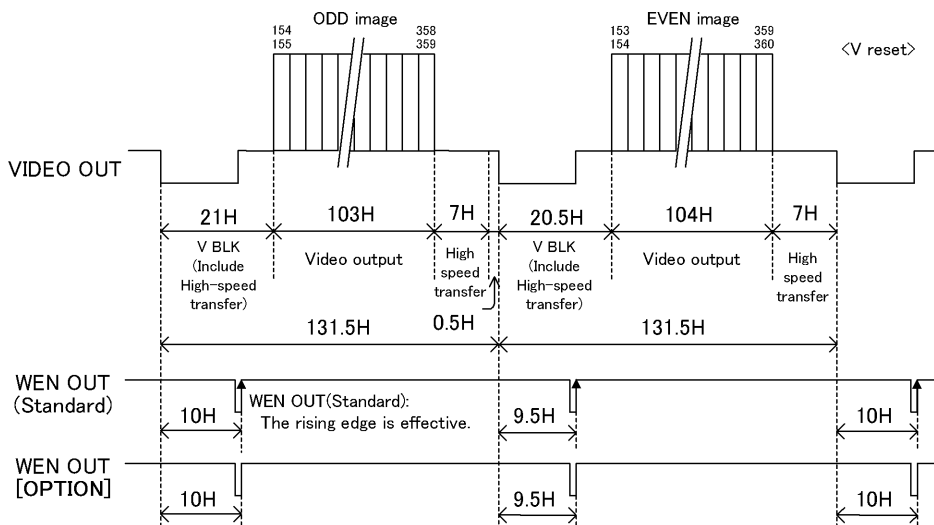

■ Under other shutter modes

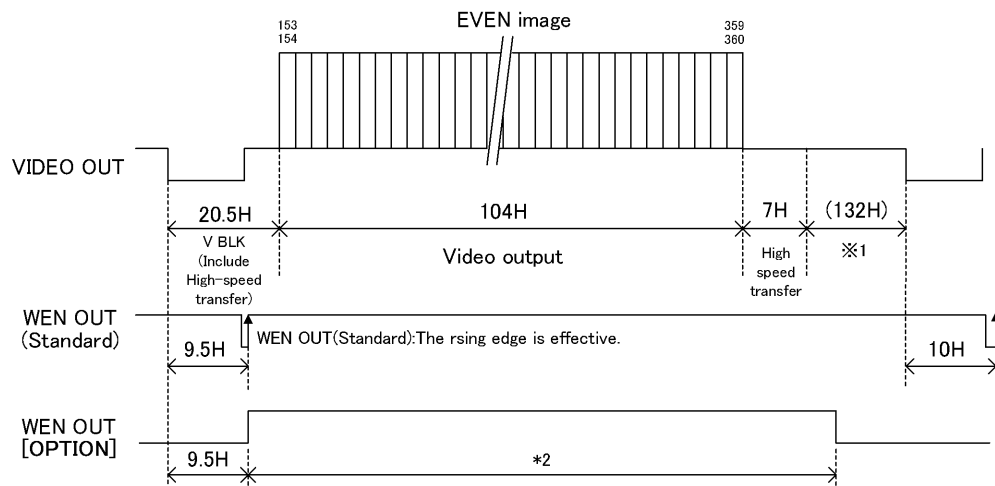
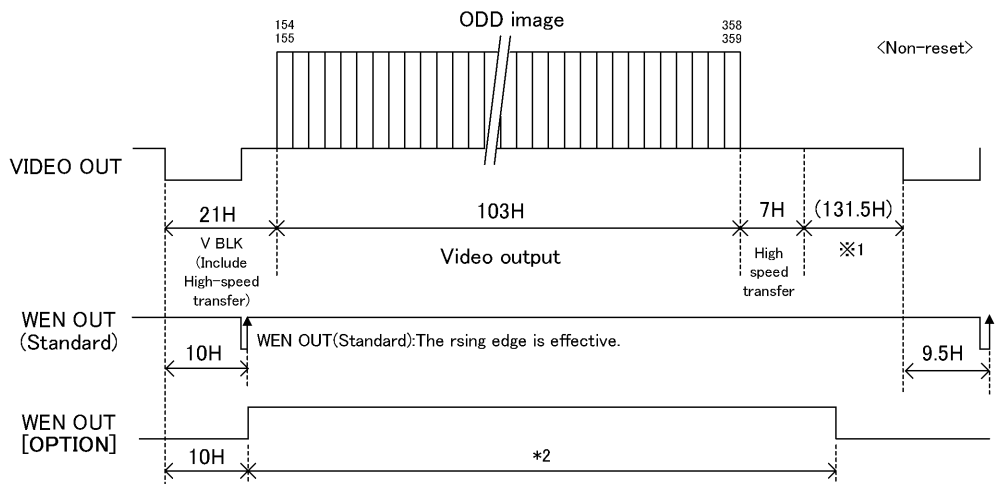

*1:Arbitrary under ex-sync
 *2:See "7.TIMING CHART (4) WEN timing".

(6-2)1/4 Partial-scan (Rear-panel SW: #7-ON, #8-ON) --- Screen center 1/4 readout

□ 1/60s Non-interlace

Under 1/60s non-interlace mode, only the center portion of 75H out of the total effective lines 492H (excluding BLK time) is read out. Available both under external / internal mode.

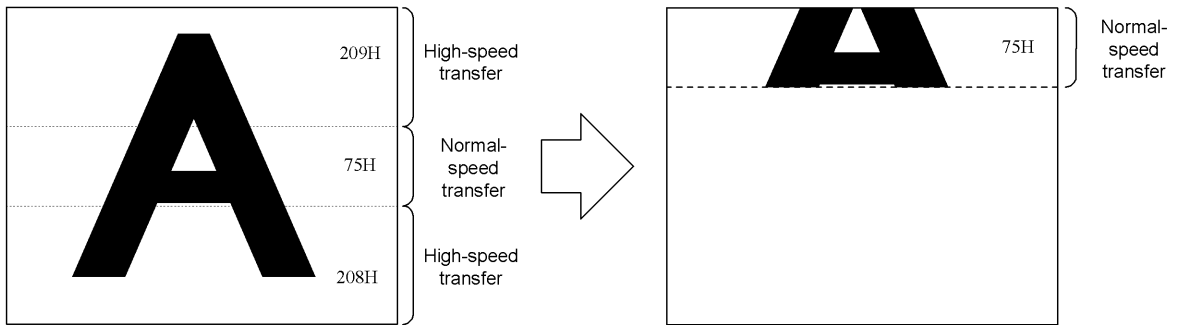

■ Under normal shutter (Electronic shutter OFF)

Notes: * Under ext. sync, the ext. VD should be 1V = 131H.

** Under normal shutter, set the rear-panel DIP SW #5, #6 in OFF.

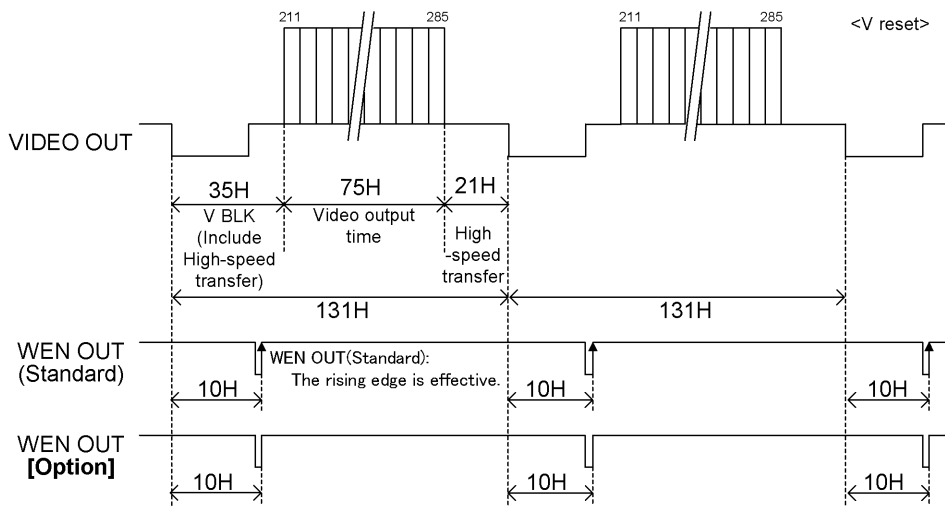

■ Under other shutter modes

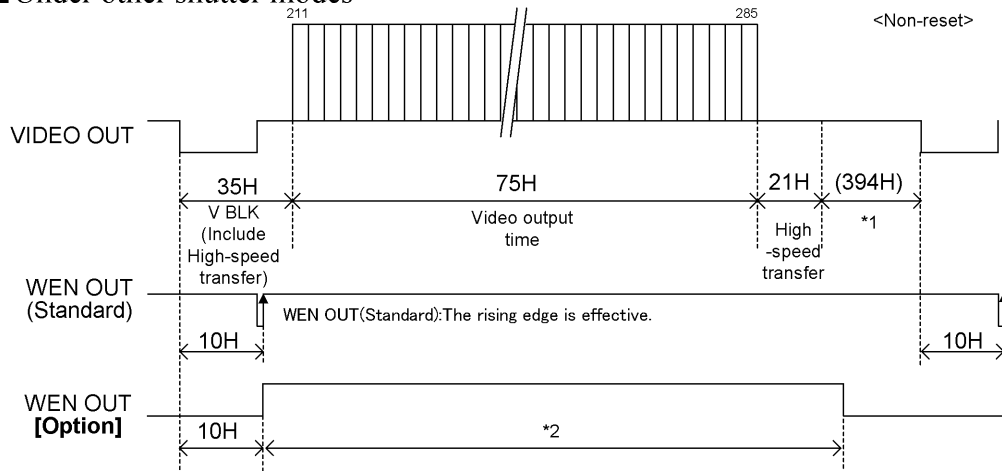

*1:Arbitrary under ext.sync

*2:See "7.TIMING CHART (4)WEN timing".

□ 1/120s 2:1 Interlace

Under 1/120s interlace mode, only the center portion of 61H out of the total effective lines 485H (excluding BLK time) is read out. Available both under external / internal mode.

ODD Field

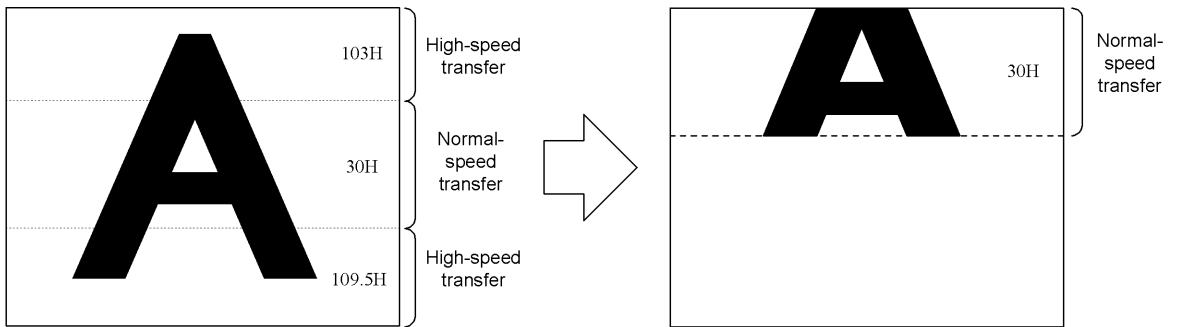

EVEN Field

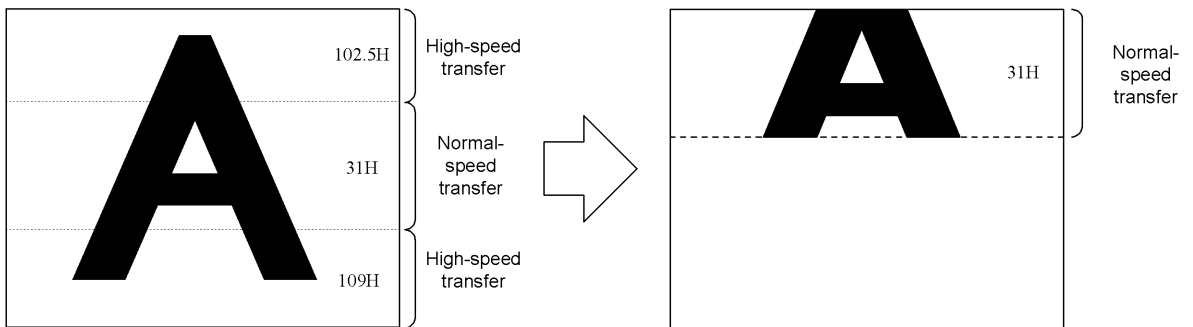

■ Under normal shutter (Electronic shutter OFF)

Notes: * Under ext. sync, the ext. VD should be $1V = 65.5H$.

** Under normal shutter, set the rear-panel DIP SW #5, #6 in OFF.

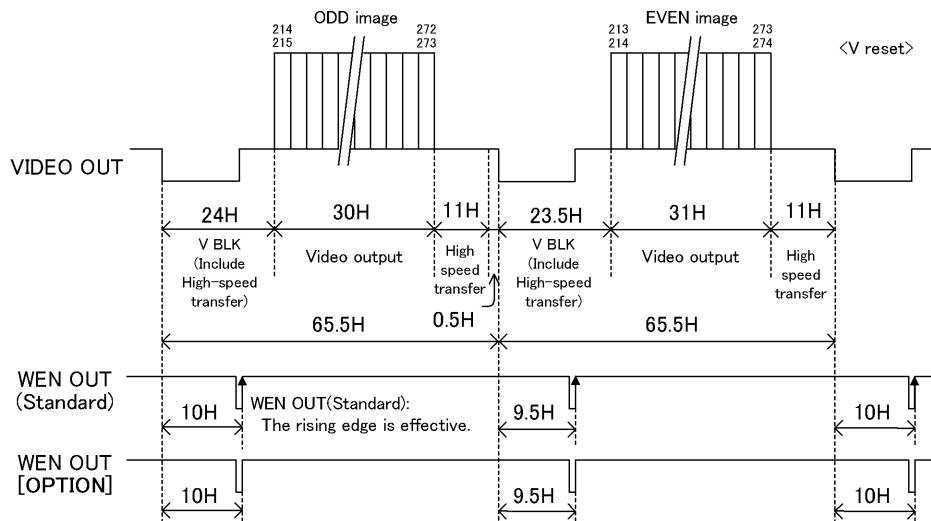

■ Under other shutter modes

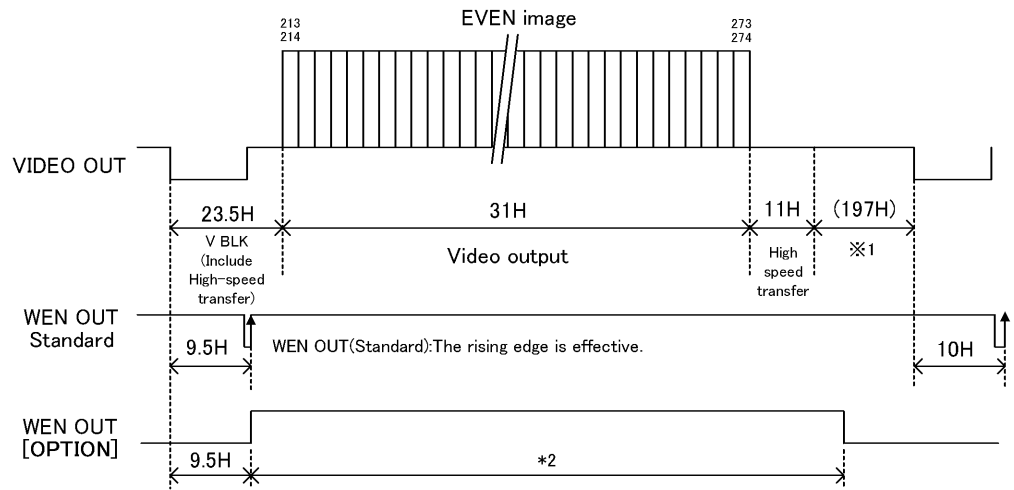
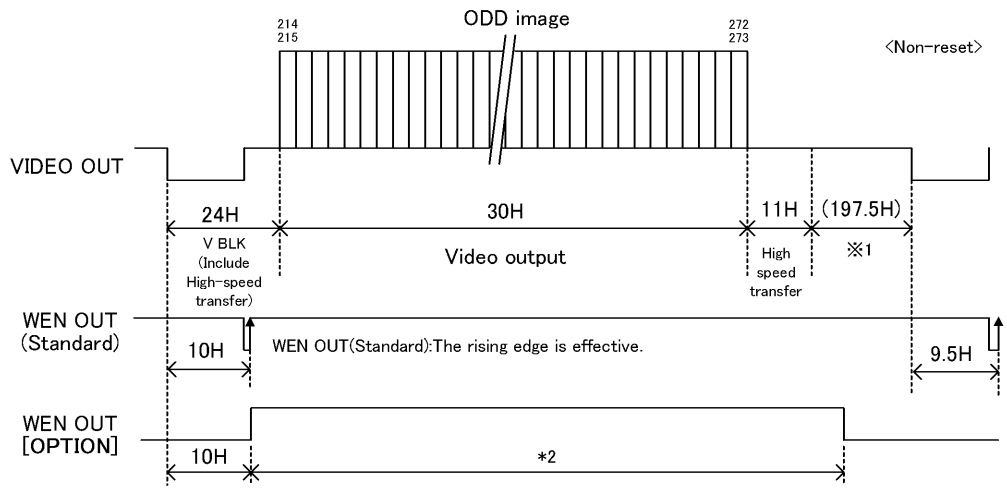

*1:Arbitrary under ex-sync
*2:See "7.TIMING CHART (4) WEN timing".

(6-3) Programmable partial **[Option]**

By designating the high-speed transfer portion with external PARTIAL signal input, the camera read out only the portion of CCD area necessary for your application. This is available under ext. sync.

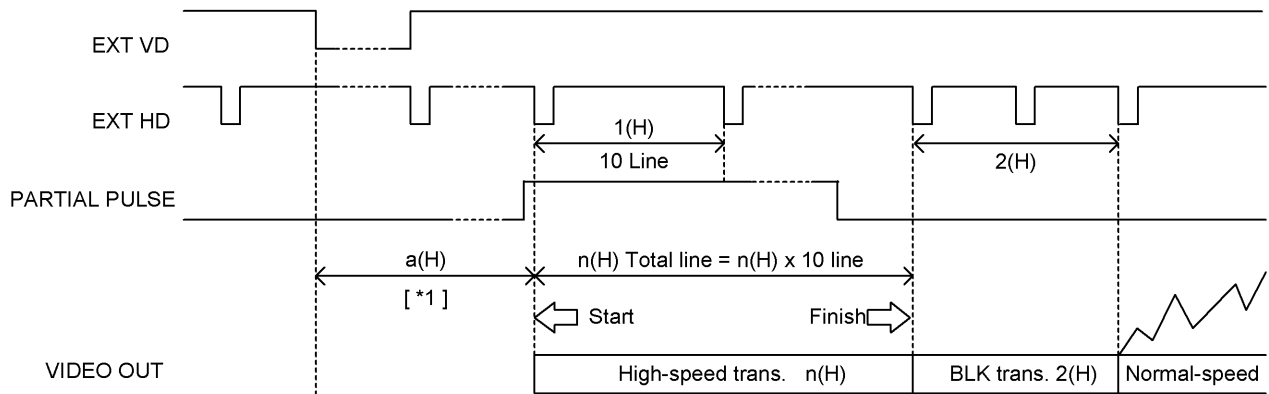

(Conditions)

- The starting point of external partial signal is [*1] from the falling edge of ext. VD.
- The external partial signal is controlled at each ext. HD falling edge. Set the start / finish of the external partial signal in 1H increments.
- The number of 1H high-speed transfer line is 10 lines. The actual lines are determined by the external partial signal “hi” period. (Minimum: 2H = 20 lines)
- After high-speed transfer, 2H is allocated to blank transfer period. Normal transfer starts at the next line.
- VIDEO OUT vertical blanking is;

$$V. \text{ blanking} = [*1](H) + n(H) + \text{BLK transfer } [2(H)] - 1H$$

Example follows below.

(High-speed 2H = 20 lines (minimum), Normal-speed 70 lines + BLK 2H)

Note: Items shown as [Option] in this document is not included in your purchase as standard components. Contact our dealer / distributor for details.

□ 1/60s Non-interlace

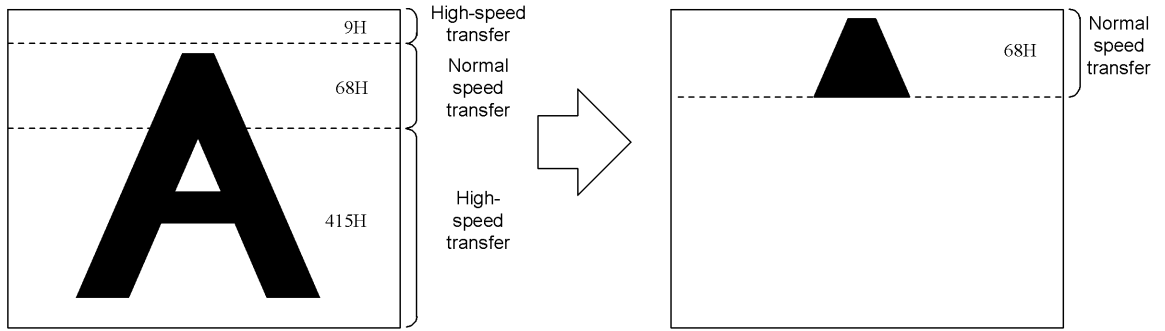

The timing is as follows;

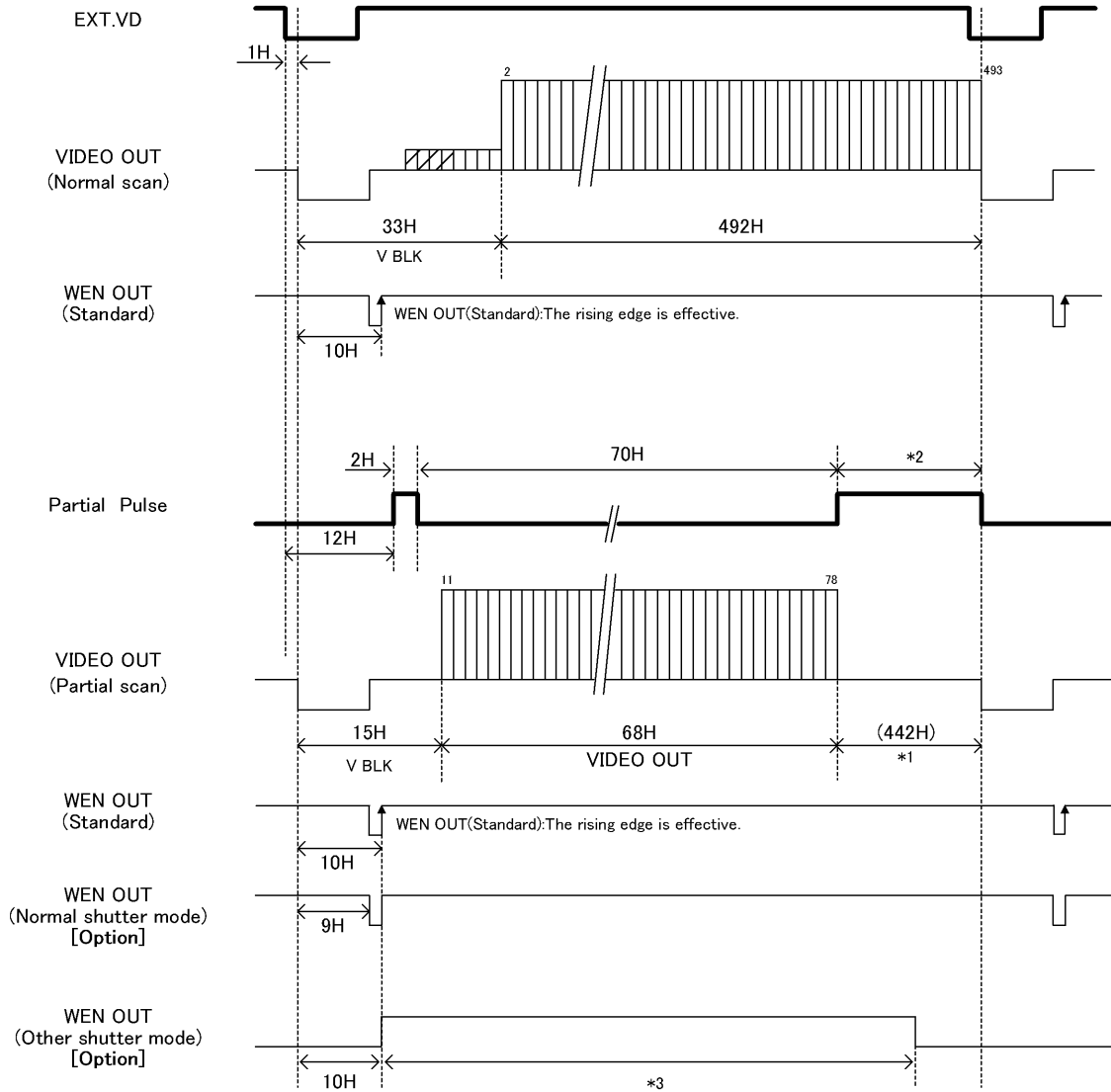

*1:Arbitrary under ext.sync.
 *2:Partial over actual line is OK.
 *3:See "7.TIMING CHART (4)WEN Timing".

□ 1/120s 2:1 Interlace, ODD field

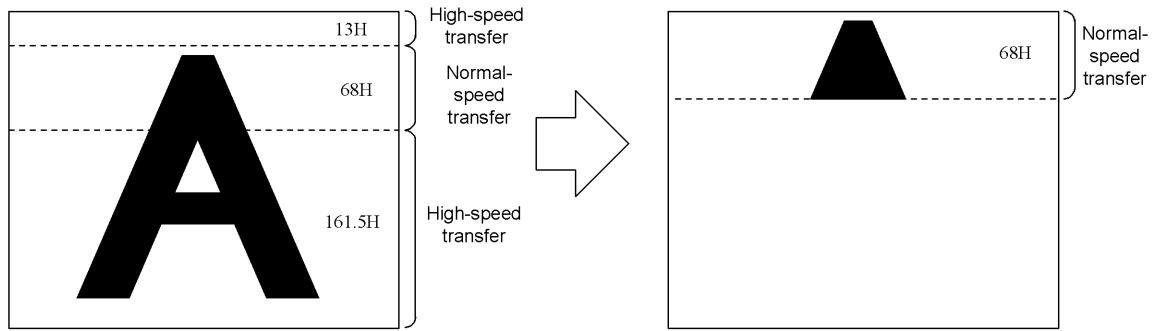

The timing is as follows;

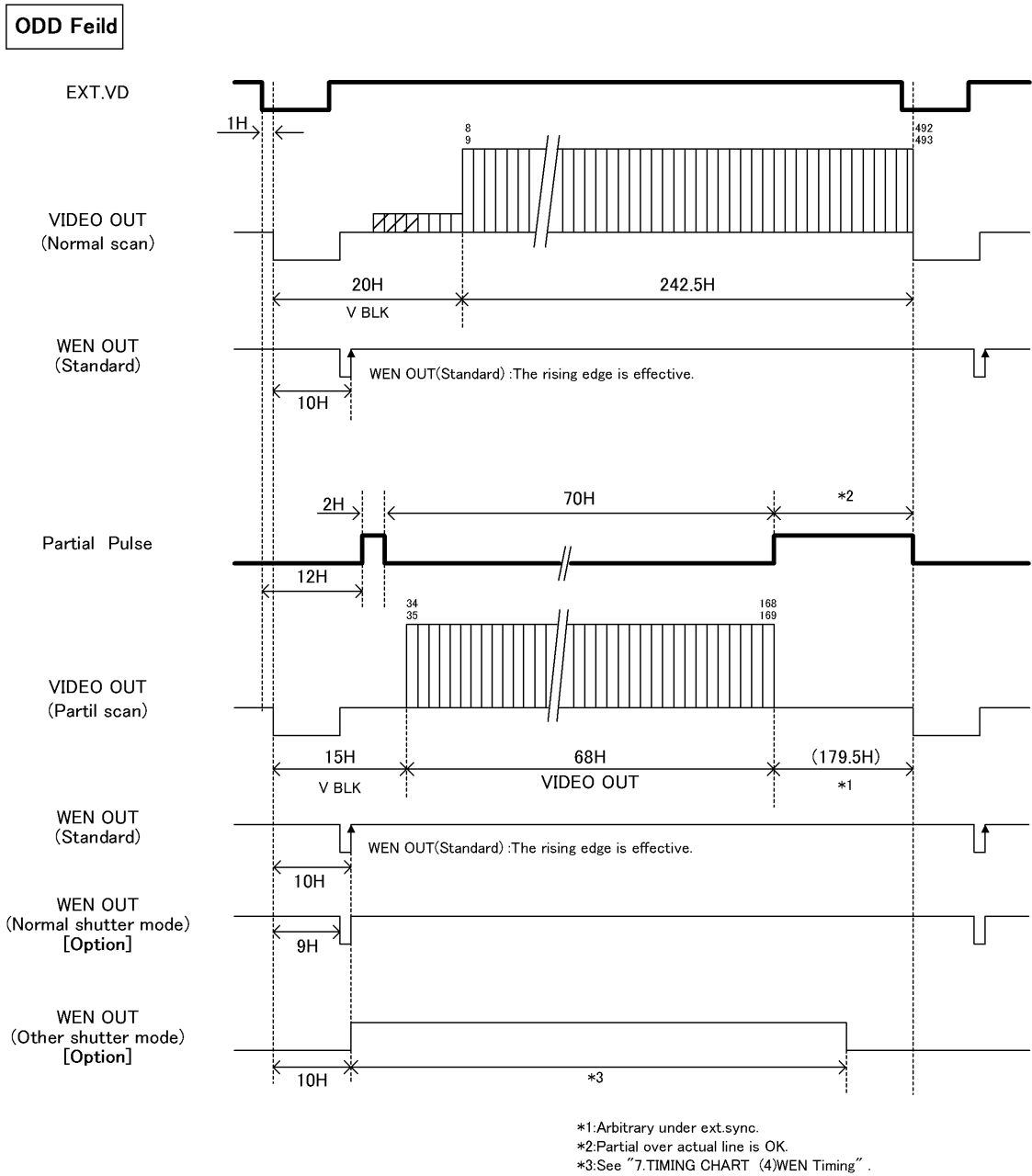

□ 1/120s 2:1 Interlace, EVEN field

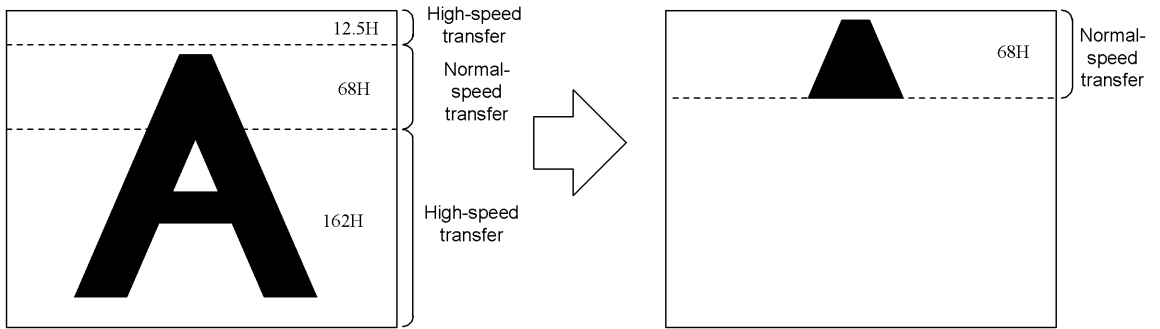

The timing is as follows;

EVEN Field

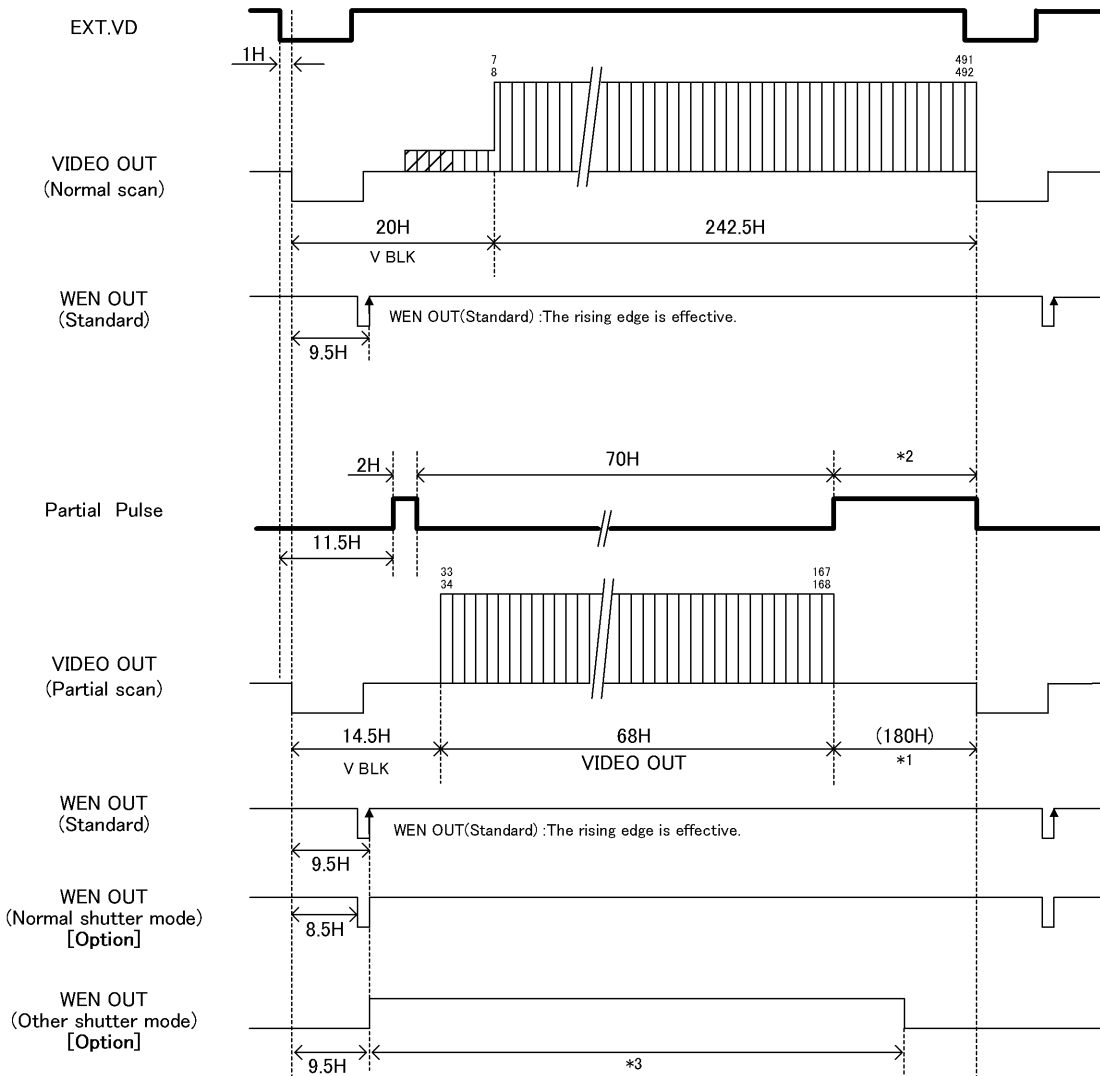

*1:Arbitrary under ext.sync.
 *2:Partial over actual line is OK.
 *3:See "7.TIMING CHART (4)WEN Timing".

(6-4) Partial-scan ON/OFF external control [Option]

Partial-scan ON/OFF is externally controllable without using rear-panel DIP SW. This external control is available under 1/2 partial mode only, not under 1/4 partial and programmable partial scan. (Rear-panel 8 pin connector: High --- 1/2 partial ON, LOW --- Partial OFF)

Note: Items shown as [Option] in this document is not included in your purchase as standard components. Contact our dealer / distributor for details.

6. SPECIFICATIONS

[Basic spec]

(1) Image sensor	All Pixel's Data Read-out Interline CCD
Total pixels	692(H) x 504(V)
Active pixel	659(H) x 494(V)
Video output pixels	648(H) x 492(V) (Under non-interlace)
Scanning area	4.88(H) x 3.66(V) mm (=Equivalent to 1/3 type CCD size)
Unit cell size	7.4(H) x 7.4(V) micro m (Square-grid array)
(2) TV system	Special format (Non-conforming to EIA)
(3) Scanning lines	525 lines
(4) Interlace	1/60s Non-interlace mode 1/120s 2:1 Interlace mode Switching via rear-panel DIP SW
(5) Sync system	Internal/External automatic switch-over
(6) Aspect ratio	4:3
(7) Video output	VS 1.0V(p-p) / 75 Ω , DC coupled, 1 line (AC as [Option])
(8) Resolution	485 TV lines(H) 485 lines (350 TV lines)(V)
(9) S/N	Standard: 52dB(p-p)/rms (Initial factory setting)
(10) Illumination	Standard 400 lx (F5.6) Minimum 4 lx (F1.4) (GAIN MAX, Approx. 50% video output)
(11) Gain	FIX (Fixed) gain: Factory-shipped preset level MANU (Manual) gain: Setting through GAIN VR FIX / MANU switching via rear-panel DIP SW
(12) Gamma correction	Gamma = 1 (Fixed)
(13) White-clip level	Approx. 840mV(p-p) (Excluding SYNC)
(14) Power source	DC12V \pm 10% Ripple voltage: 50mV(p-p) or less
(15) Power consumption	Approx. 1.8W

[Internal sync spec]

(1) Base clock frequency	24.545MHz (1CLK) \pm 200ppm
(2) H sync frequency	31.468kHz (1H = 780CLK)
(3) V sync frequency	59.94Hz (Under non-interlace) 119.88Hz (Under 2:1 interlace)

Note: Items shown as [Option] in this document is not included in your purchase as standard components. Contact our dealer / distributor for details.

[External sync spec]

- | | |
|----------------------------|--|
| (1) Ext. sync input signal | HD/VD |
| (2) Input level | From 2 through 4V (p-p) |
| (3) Input impedance | 75-ohm / High impedance 10k-ohm (switching via rear-panel SW)
(Initial factory setting: High) |
| (4) Interlace | 1/60s non-interlace or 1/120s 2:1 interlace |
| (5) Polarity | Negative |
| (6) Pulse width | HD: 3.2 +/- 1 micro s (LOW)
VD: From 125 through 400 micro s (LOW) |
| (7) Repeating frequency | $f_H = 31.468\text{kHz} \pm 1\%$
$f_V = f_H/262.5$ or $f_H/525$ |
| (8) Phase difference | HD/VD: 0 +/- 5.0 micro s, $1/f_H/2 \pm 5.0$ micro s |

[Shutter trigger spec]

- | | |
|---------------------|---|
| | Exposure-starting-cue signal in random trigger shutter mode |
| (1) Input level | LOW level: From 0 through 0.5V(p-p)
HIGH level: From 4 through 5V(p-p) |
| (2) Input impedance | High impedance (10k-ohm) |
| (3) Capture timing | Rising edge detection (Positive) / Falling edge detection (Negative)
(Switching via rear-panel DIP SW)
(Initial factory setting: Rising edge) |
| (4) Pulse width | Minimum 2 micro s
Maximum 1/8s |

[Sync signal spec]

- | | |
|--------------------|---|
| (1) Readout signal | WEN readout timing signal (No output in use of CS8550Di-01) |
| (2) Polarity | Rising edge (Positive under 1V mode [Option]) |
| (3) Output circuit | |

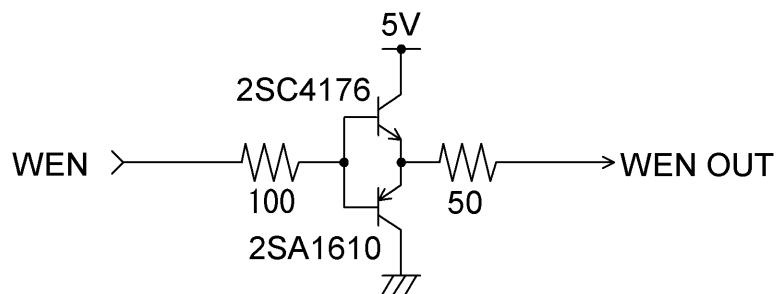

Note: Items shown as [Option] in this document is not included in your purchase as standard components. Contact our dealer / distributor for details.

[Electronic shutter spec]

(1)Normal shutter

Shutter-speed setting via rear-panel SW (Initial: OFF)

8 steps switch-able (= OFF, 1/200s, 1/500s, 1/1000s, 1/2000s, 1/4000s, 1/8000s, 1/20000s)

(2)RTS

(a)Operation mode

No.	Reset	Exposure	Sync
1	Non-reset	Rear SW (FIX mode)	Internal
2			Consecutive HD / Consecutive VD IN
3			Consecutive HD / Single VD IN
4		TRIG pulse width (PULSE width mode)	Internal
5			Consecutive HD / Consecutive VD IN
6			Consecutive HD / Single VD IN
7	V-reset	Rear SW (FIX mode)	Internal
8			Consecutive HD IN
9	SYNC reset		Internal
10	V reset	TRIG pulse width (PULSE width mode)	Internal
11			Consecutive HD IN

Notes : * RTS mode automatically switches over through TRIG IN

**RTS disabled under Electronic shutter OFF

(b)Multiple shutter

Multiple shutter via ext. trigger signal and ext. VD signal

Notes : * Operation like No.3, 6 above

(3)Restart / Reset

Restart / reset available via ext. VD signal

(Switching via rear panel DIP SW, Initial OFF)

Notes : * The exposure-time (shutter-speed) is determined by ext. VD interval.

** Enabled when rear-panel DIP SW OFF.

***Provide Consecutive HD.

[Partial scan]

(1)Operation mode

No	Scan mode	Sync	Reset	E-shutter Normal	E-shutter RTS
1	1/2 partial	Internal	Non-reset	Enabled [Option]	Enabled
2			V-reset	Disabled	
3		Consecutive HD VD IN	Non-reset	Enabled [Option]	Enabled
4		Consecutive HD (VD) IN	V-reset	Disabled	
5	1/4 partial	Internal	Non-reset	Enabled [Option]	Enabled
6			V-reset	Disabled	
7		Consecutive HD VD IN	Non-reset	Enabled [Option]	Enabled
8		Consecutive HD (VD) IN	V-reset	Disabled	
9	Programmable	Consecutive HD VD IN	Non-reset	Enabled [Option]	Enabled [Option]

Note: Items shown as [Option] in this document is not included in your purchase as standard components. Contact our dealer / distributor for details.

(2) Reset mode

As shown in (1) above, non-reset and V-reset is available.

([Option]: Doesn't come as standard. Contact our dealer / distributor for details)

(a) non-reset (Electronic shutter enabled)

VD doesn't get reset after video readout. The interval of VD signal is as follows.

	1/2 partial scan	1/4 partial scan
1/60s non-interlace	525H	525H
1/120s interlace	262.5H	262.5H

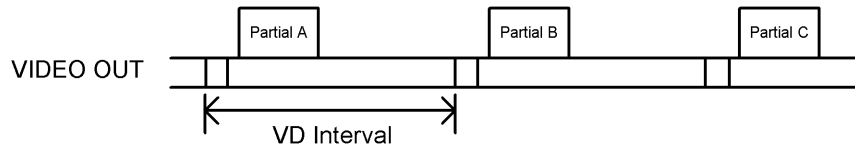

*Note: Under normal shutter mode, when non-reset is selected on partial scan, electronic shutter is valid.

Please note that the exposure time is shortened than the setting value when the external VD is input at shorter than the above VD interval.

(b) V-reset (Electronic shutter disabled)

VD does get reset after video readout. Under internal sync, the interval of VD signal is as follows.

	1/2 partial scan	1/4 partial scan
1/60s non-interlace	262H	131H
1/120s interlace	131.5H	65.5H

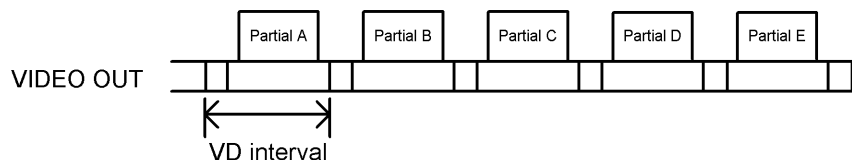

(3) Partial signal **[Option]**

Programmable mode input signal

- (a) Input level LOW level: From 0 through 0.5V
 HIGH level: From 4 through 5V
- (b) Input impedance High impedance (10kΩ)
- (c) Polarity Positive (Hi: High-speed transfer)

(4) PAR CONT signal **[Option]**

Partial-scan ON/OFF external control mode input signal

- (a) Input level LOW level: From 0 through 0.5V
 HIGH level: From 4 through 5V
- (b) Input impedance High impedance (10kΩ)
- (c) Polarity High: 1/2 partial scan ON
 Low: Partial scan OFF

Note: Items shown as [Option] in this document is not included in your purchase as standard components. Contact our dealer / distributor for details.

[Mechanical spec]

- (1) External dimension 29 x 29 x 39.5(D) mm (Not including protrusion)
Refer to the attached external view drawing
- (2) Weight Approximately 50g
- (3) Lens mount C mount
- (4) GND / insulation Circuit GND - Chassis electrically conducted

[Ambient condition]

- Performance guaranteed Temperature: From 0 through 40 °C
Humidity: From 30 through 90 % (No condensing)
- Operation guaranteed Temperature: From -5 through 50 °C
Humidity: From 10 through 90 % (No condensing)
- Storage Temperature: From -20 through 60 °C
Humidity: From 10 through 90 % (No condensing)
- EMI Conforms to EN61000-6-4

[Connector pin assignment]

- (1) Compatible connector HR10A-10P-12S (Supplied by HIROSE ELEC.)
- (2) Pin assignment

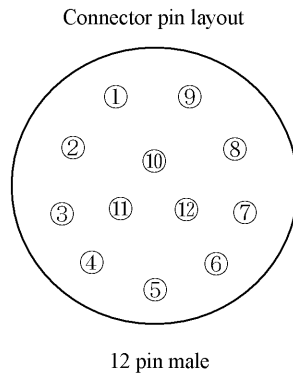

Picture Rear-panel camera connector (Rear-view)

Pin No.	Signal (Standard)	Signal [Option]		CS8550Di	CS8550Di-01
1	DC12V GND			DC12V GND	
2	DC12V			DC12V	
3	VIDEO GND			VIDEO GND	
4	VIDEO OUT			VIDEO OUT	
5	HD GND			HD GND	
6	HD IN			HD IN	
7	VD IN			VD IN	
8	TRIG GND	NC	PAR CONT	TRIG GND	
9	NC	TRIG IN		NC	TRIG IN
10	WEN OUT	GND		WEN OUT	GND
11	TRIG IN	DC12V	NC	TRIG IN	DC12V
12	VD GND	PARTIAL		VD GND	

Notes : *Before connecting / disconnecting the connector, make sure the camera power is OFF.
**For board connection, check compatibility.

Note: Items shown as [Option] in this document is not included in your purchase as standard components. Contact our dealer / distributor for details.

[Switch setting]

(1) CCU rear-panel DIP SW

No.	Function	OFF	ON
1	E-shutter-speed (SHUT)	See shutter-speed table (Table 1)	
2			
3			
4	Video output mode (VIDEO)	1/60s non-interlace	1/120s interlace
5	Shutter mode (SMODE)	See shutter-mode table (Table 3)	
6			
7	Partial scan (PART)	See partial-scan table (Table 2)	
8			
9	TRIG polarity (TRIG)	Positive (Rising edge)	Negative (Falling edge)
0	RTS Exposure (EXP)	FIX mode	PULSE W mode

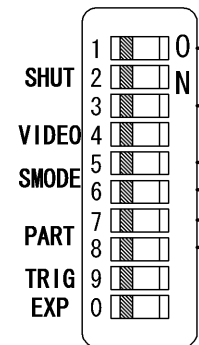

Notes: *Initial factory setting: All OFF

**Set No.9 OFF when TRIG IN OPEN.

(Table 1) Electronic shutter-speed

Shutter-speed	No.1	No.2	No.3
OFF	OFF	OFF	OFF
1/200s	ON	OFF	OFF
1/500s	OFF	ON	OFF
1/1000s	ON	ON	OFF
1/2000s	OFF	OFF	ON
1/4000s	ON	OFF	ON
1/8000s	OFF	ON	ON
1/20000s	ON	ON	ON

(Table 2) Partial-scan

Partial scan	No.7	No.8
OFF	OFF	OFF
Not acceptable	ON	OFF
1/2 partial	OFF	ON
1/4 partial	ON	ON

Notes : *Don't set Electronic shutter-speed in OFF under RTS mode.

(Table 3) Shutter-mode

Shutter mode		No.5	No.6	SYNC	
Random trigger	V reset	OFF	OFF	Internal sync	
	SYNC reset	ON	OFF		
	Non-reset	OFF	ON		
Not acceptable		ON	ON		
Random trigger	Non-reset (Multiple shutter)	OFF	OFF	Single VD	Ext. sync HD IN
	Non-reset	ON	OFF	Consecutive VD	
	V reset	OFF	ON	No VD	
Restart / Reset		ON	ON	Single VD	

Notes : * Under normal shutter mode partial-scan, set No.5, 6 in OFF.

**Under PULSE W mode, SYNC reset is disabled.

(2)CCU rear-panel SW

Function	SW	Selected Function
Ext. SYNC IN impedance (HD/VD)	HIGH	HIGH impedance (Initial factory setting)
	75Ω	75Ω
GAIN selection (GAIN)	F	Factory-set GAIN
	M	Manual GAIN adjustable via GAIN potentiometer

[Relative Spectrum Response]

*Including lens characteristics, Excluding light source characteristics

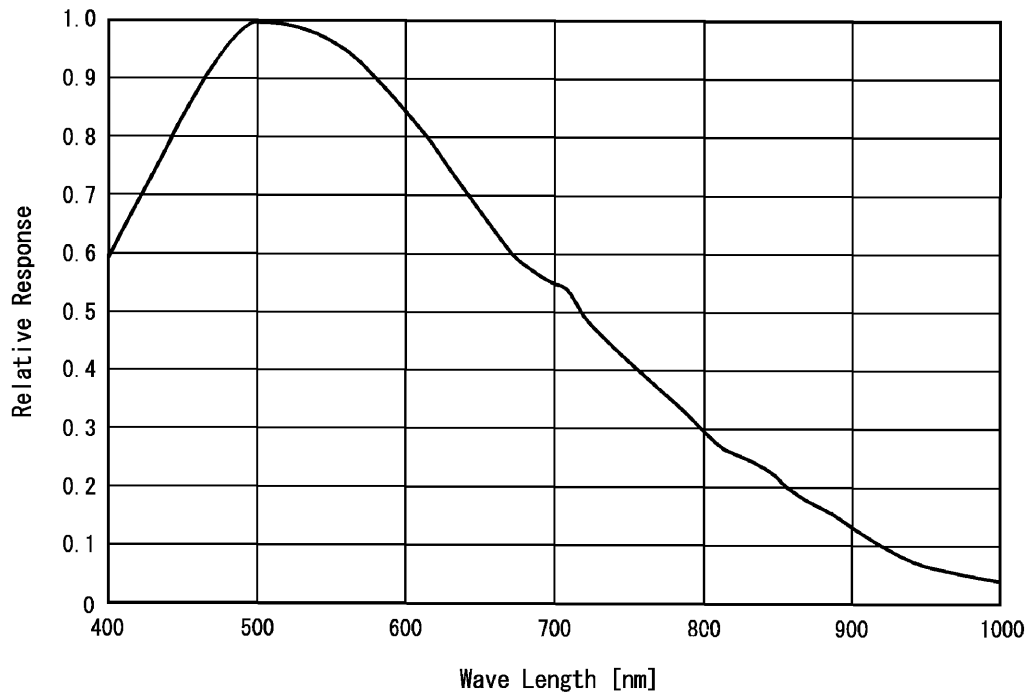

[Optical black characteristics]

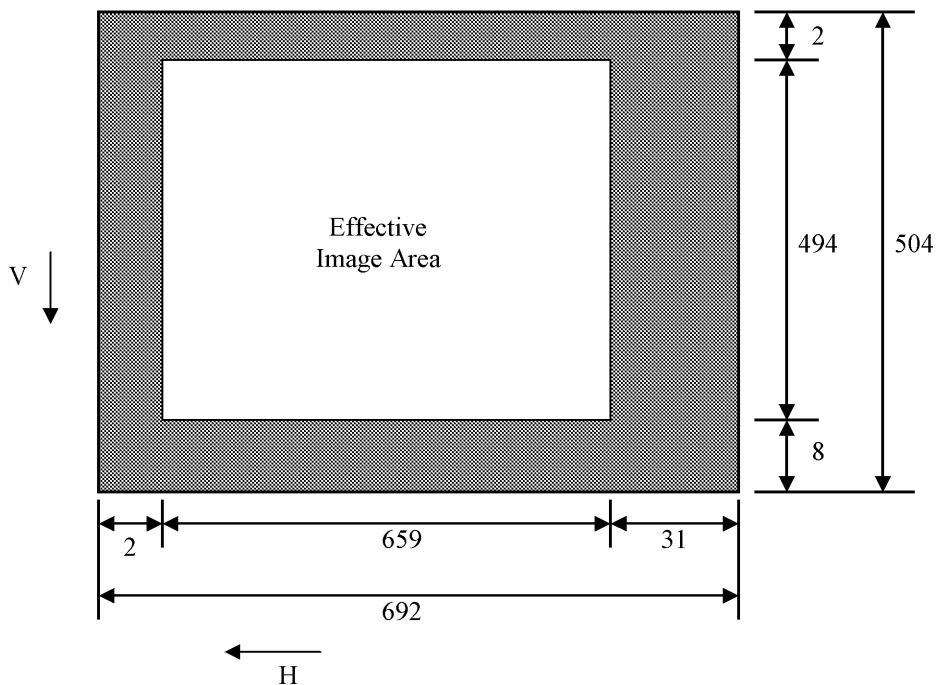

Total pixels : 692(H) x 504(V)
 Effective pixels : 659(H) x 494(V)
 Optical black
 Horizontal : 2pixels --- 31pixels
 Vertical : 8pixels --- 2pixels

7. TIMING CHART

(1) H rate timing

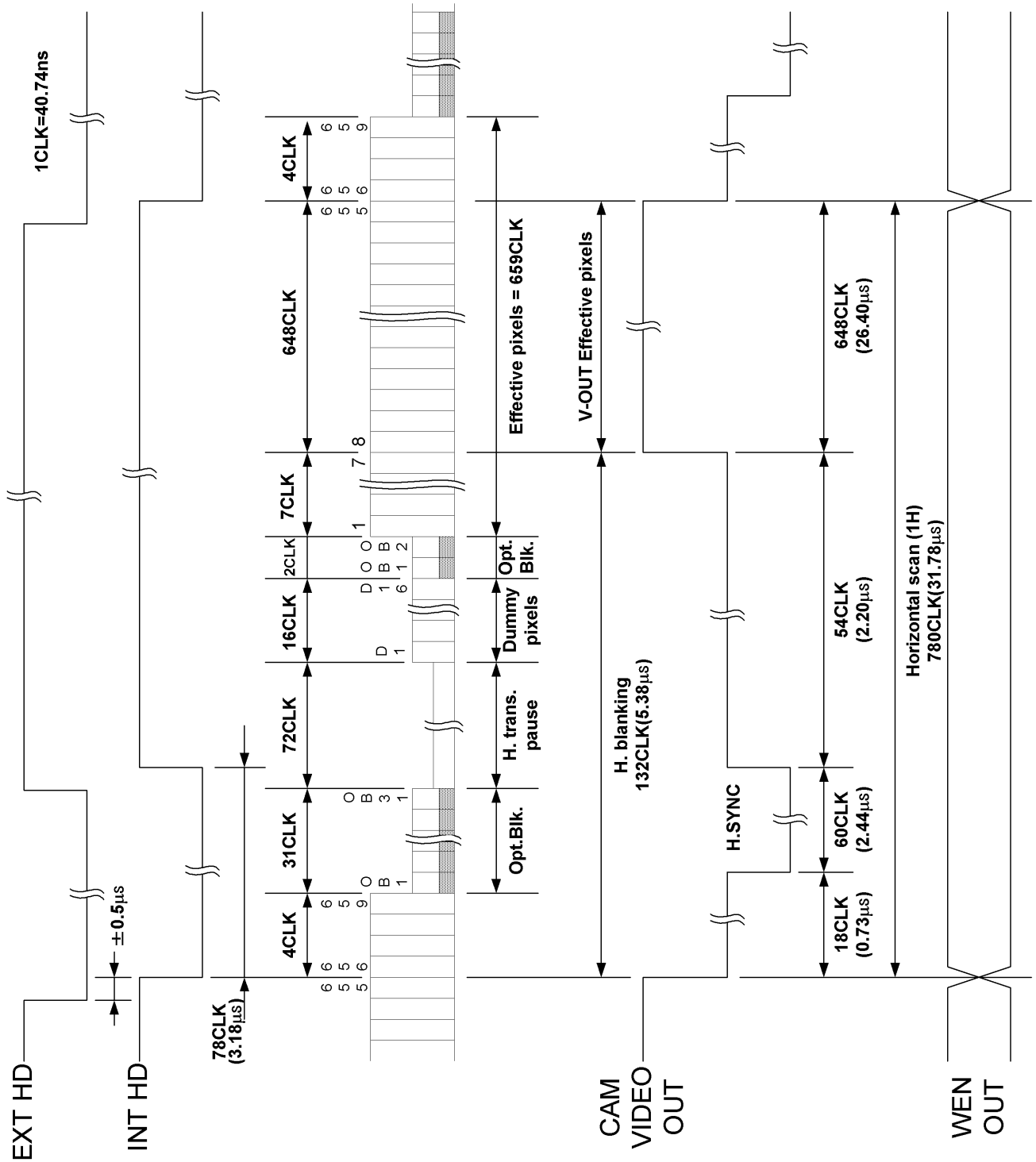

(2) 1/60s Non-interlace mode

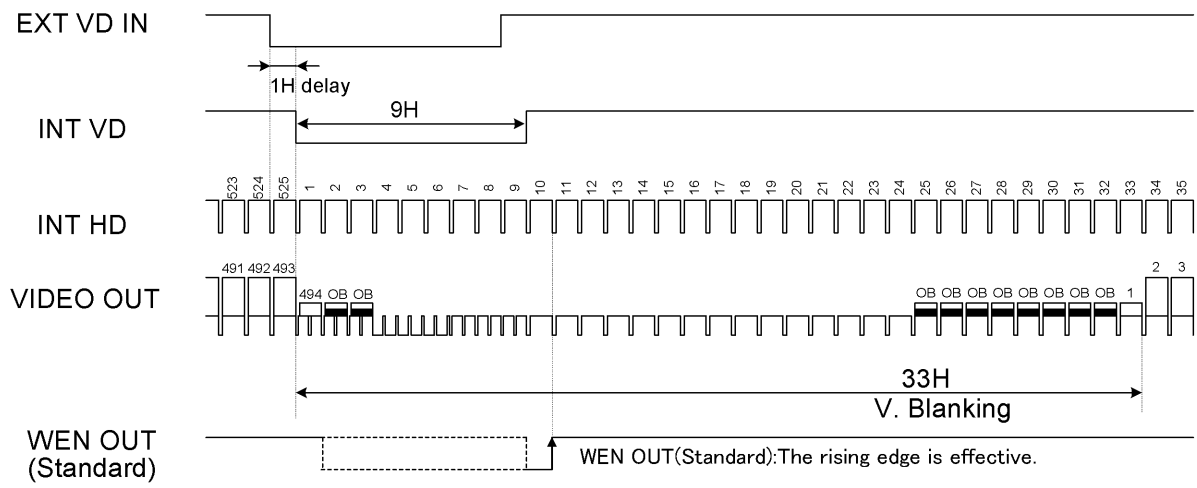

Ext. VD – Ext. HD phase difference

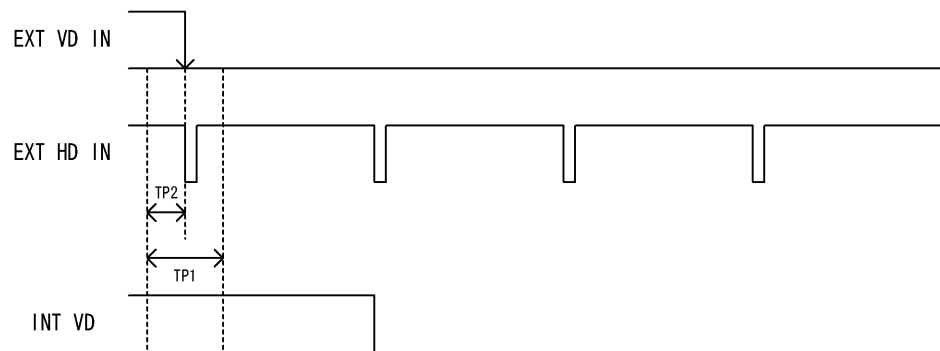

TP1 : 10.0 us
TP2 : 5.0 us

(3) 1/120s 2:1 Interlace mode

ODD (1st field)

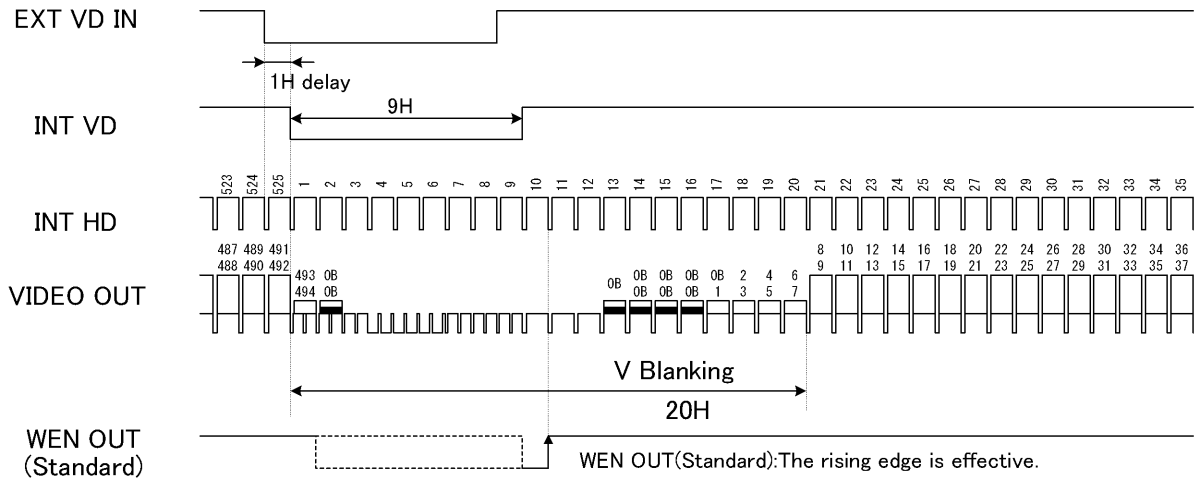

EVEN (2nd field)

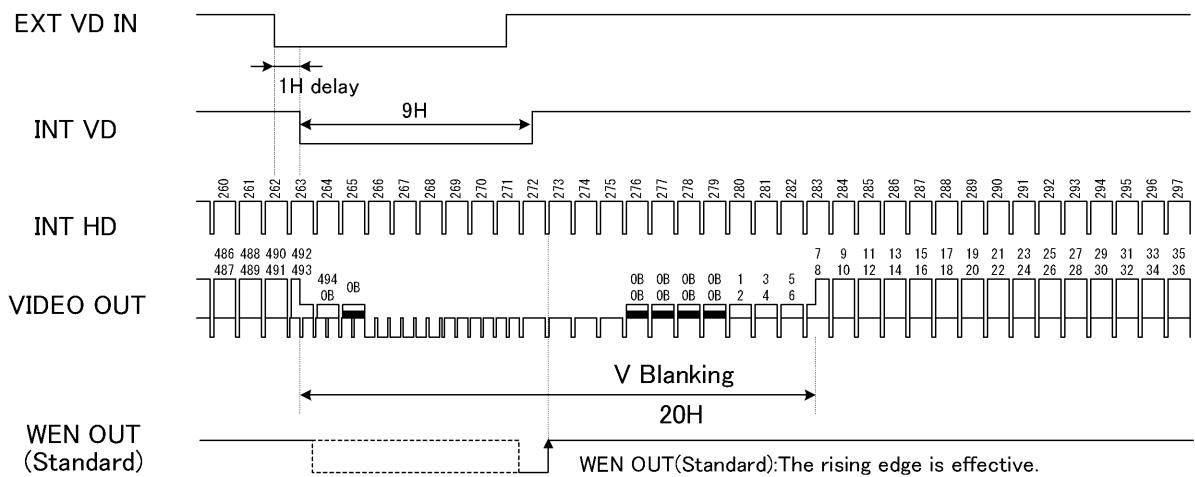

Ext. VD – Ext. HD phase difference

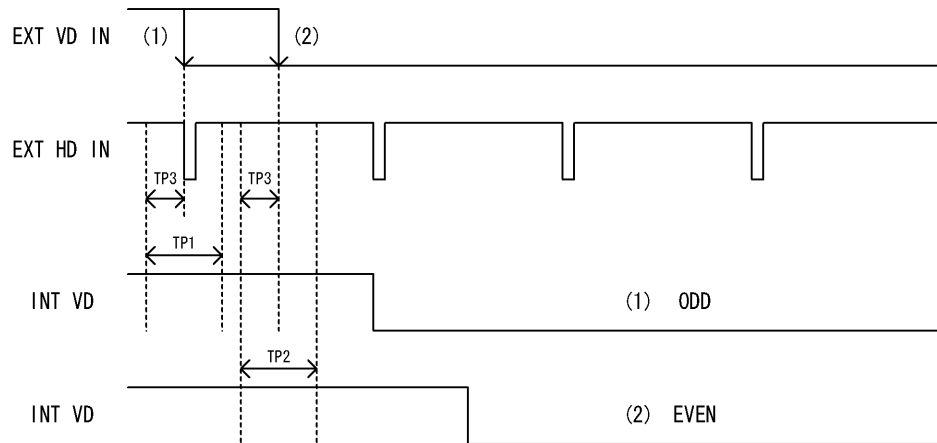

TP1 : ODD reset range 10.0 us
 TP2 : EVEN reset range 10.0 us
 TP3 : 5.0 us

(4) WEN timing
 <1/60s Non interlace mode>

WEN(Under normal shutter mode normal-scan)

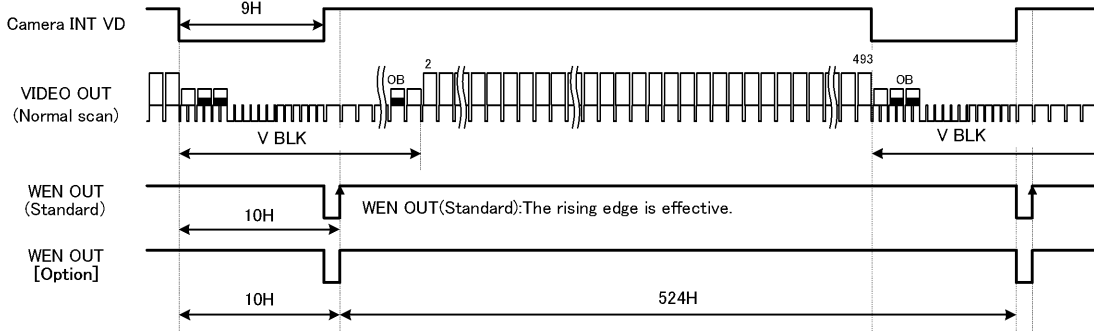

WEN(Under normal shutter mode partial-scan)

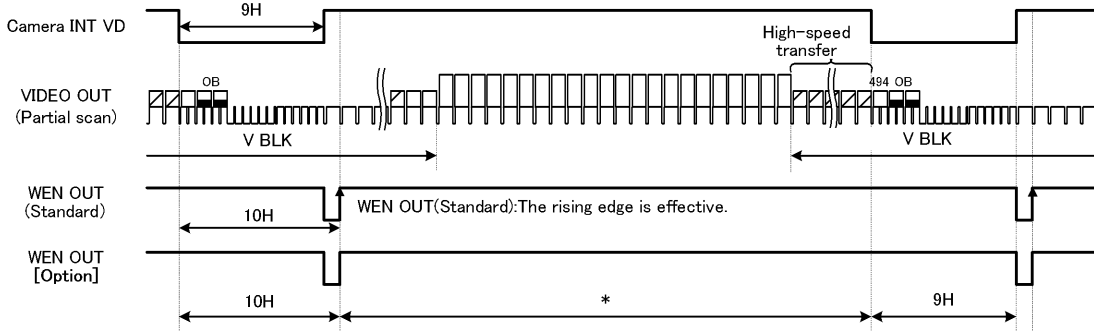

* 1/2 Partial scan: 252H
 1/4 Partial scan: 121H
 Programmable Partial scan: Arbitrary [Option]

WEN(Under other shutter mode)

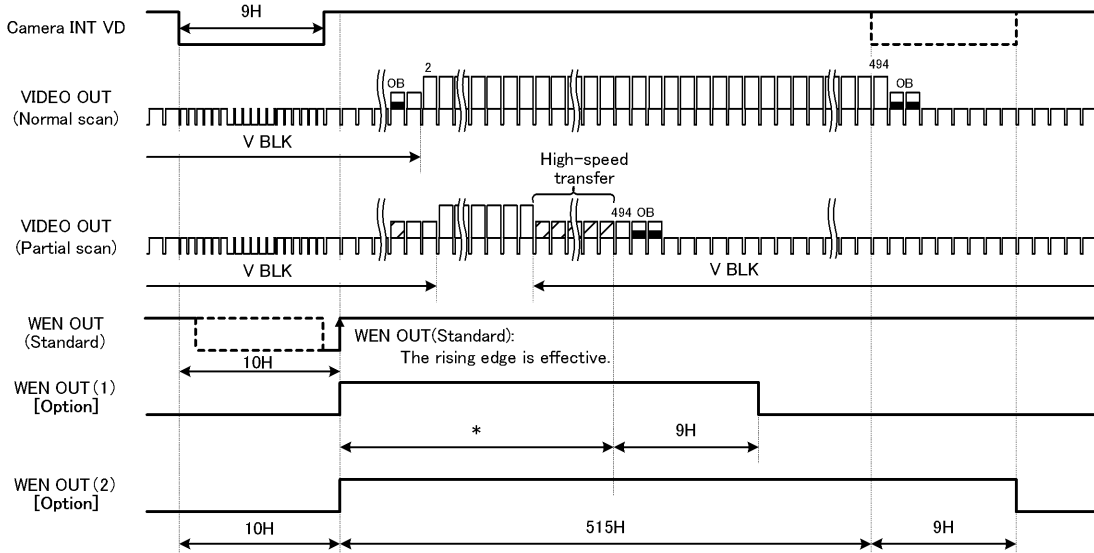

Caution : Hi-period of WEN as [Option] depends on a using shutter mode.

WEN OUT (1)	- RTS	V reset	Internal sync	Single VD
	- RTS	SYNC reset	Internal sync	
	- RTS	Non-reset	External sync	
	- RTS	V reset	External sync	
WEN OUT (2)	- RTS	Non-reset	Internal sync	Consecutive VD
	- RTS	Non-reset	External sync	
	- Restart/Reset			

* 1/2 Partial scan: 252H
 1/4 Partial scan: 121H
 Programmable Partial scan: Arbitrary [Option]

<1/120s Interlace mode>

ODD Field

WEN(Under normal shutter mode normal-scan)

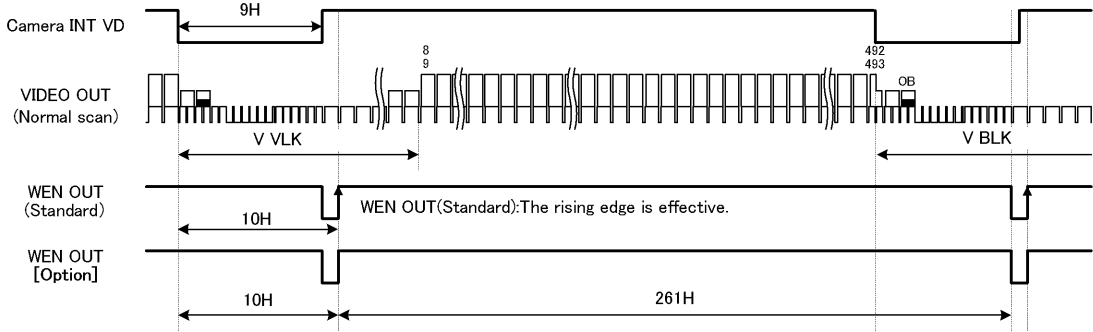

WEN(Under normal shutter mode partial-scan)

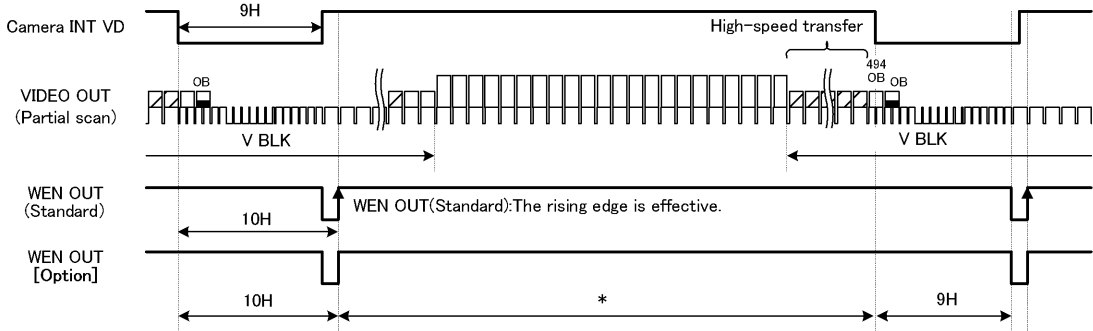

* 1/2 Partial scan: 121.5H
 1/4 Partial scan: 55.5H
 Programmable Partial scan: Arbitrary [Option]

WEN(Under other shutter mode)

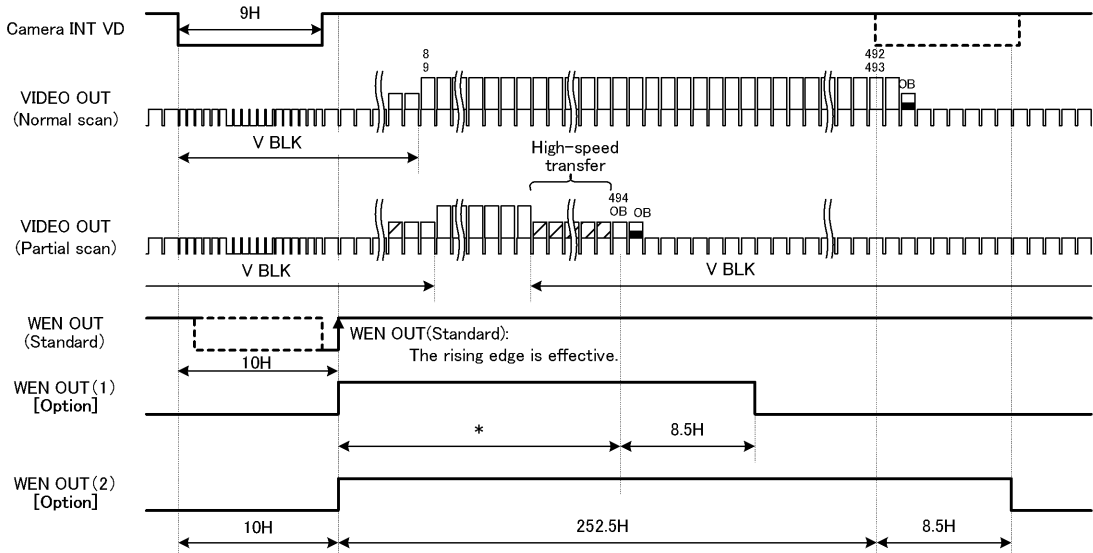

Caution : Hi-period of WEN as [Option] depends on a using shutter mode.

WEN OUT (1)	- RTS	V reset	Internal sync	Single VD
	- RTS	SYNC reset	Internal sync	
	- RTS	Non-reset	External sync	
	- RTS	V reset	External sync	
WEN OUT (2)	- RTS	Non-reset	Internal sync	Consecutive VD
	- RTS	Non-reset	External sync	
	- Restart/Reset			

* 1/2 Partial scan: 121.5H
 1/4 Partial scan: 55.5H
 Programmable Partial scan: Arbitrary [Option]

<1/120s 2:1 Interlace mode>

EVEN Field

WEN(Under normal shutter mode normal-scan)

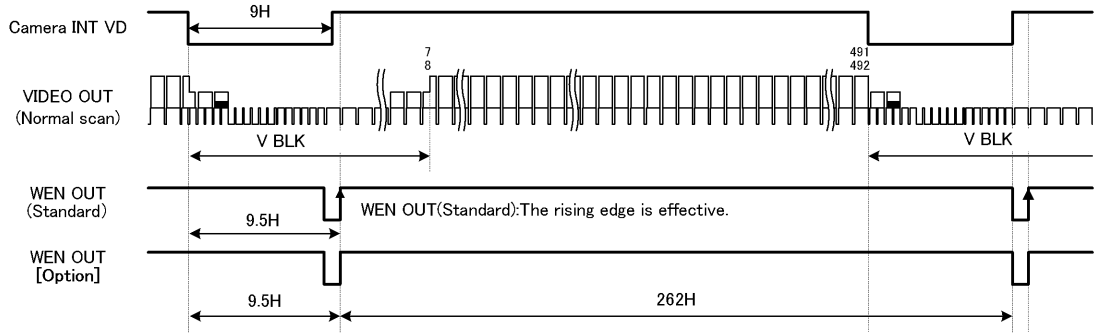

WEN(Under normal shutter mode partial-scan)

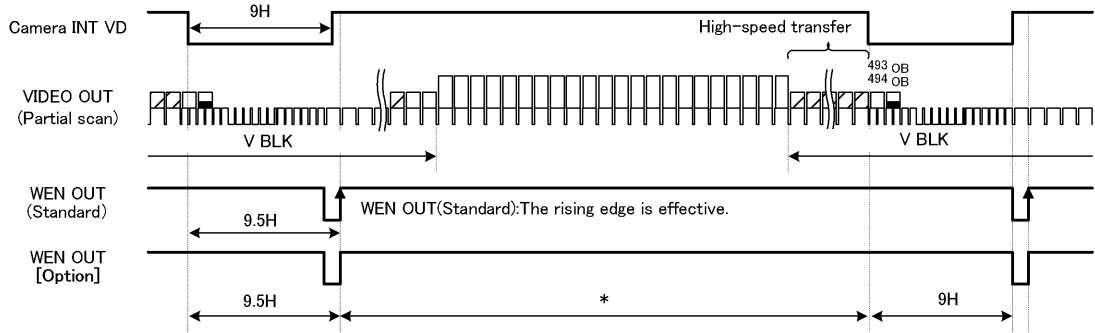

* 1/2 Partial scan: 122H
 1/4 Partial scan: 56H
 Programmable Partial scan: Arbitrary [Option]

WEN(Under other shutter mode)

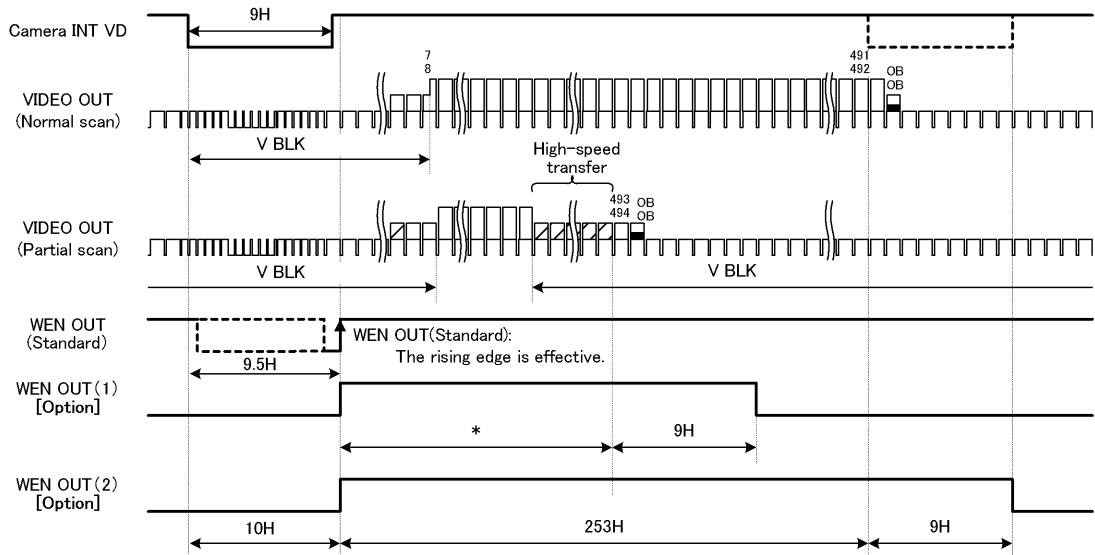

Caution : Hi-period of WEN as [Option] depends on a using shutter mode.

WEN OUT (1)	- RTS	Non-reset	External sync	Single VD
	- RTS	Non-reset	Internal sync	
WEN OUT (2)	- RTS	Non-reset	External sync	Consecutive VD
	- Restart/Reset			

* 1/2 Partial scan: 122H
 1/4 Partial scan: 56H
 Programmable Partial scan: Arbitrary [Option]

8. EXTERNAL-VIEW DRAWING

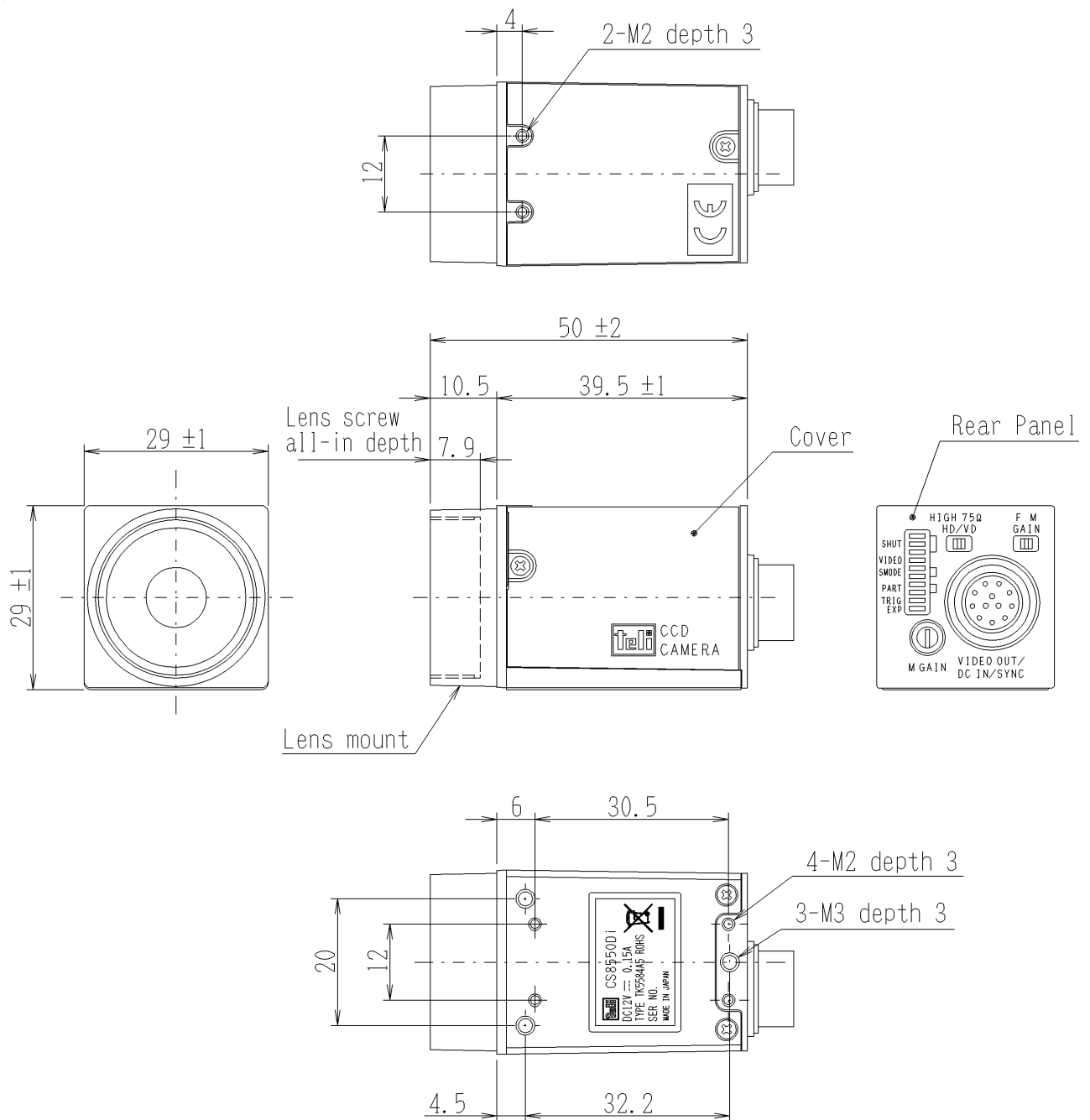

Specification

Material	Lens-mount, Rear panel: Aluminum die-cast
	Cover : Anticorrosion aluminum alloy
Processing	Lens-mount, Rear panel: Cation coating
	Cover : Leather satin coating(Black)



TOSHIBA TELI CORPORATION

Head Office: 7-1, 4 chome, Asahigaoka, Hino-shi, Tokyo, 191-0065, Japan
(Overseas Sales Department)
Phone: +81-42-589-8771 Fax: +81-42-589-8774

URL: <http://www.toshiba-teli.co.jp>

The design and specification is subject to change without notice.