



# **B/W CCD Camera**

## **Model CS8550i-51**

### **Specifications**

**(Ver.1.4)**

#### **Contents**

<b>1. Product Description .....</b>	<b>2</b>
<b>2. Features.....</b>	<b>2</b>
<b>3. Configuration.....</b>	<b>3</b>
<b>4. Option Unit.....</b>	<b>3</b>
<b>5. Operation Mode .....</b>	<b>3</b>
<b>6. Specifications .....</b>	<b>16</b>
<b>7. Timing Chart .....</b>	<b>22</b>
<b>8. External View Drawing .....</b>	<b>25</b>

**TOSHIBA TELI CORPORATION**

## **1. PRODUCT DESCRIPTION**

---

Model CS8550i-51 is an integrated type B/W CCD camera with a VGA format all-pixel-data readout CCD. The model is suited for high-speed, high-resolution image processing use. Its compact, light-weight body is ideal for system integration.

## **2. FEATURES**

---

(1) All pixel's data readout

With its built-in all-pixel-data-readout CCD, this model can read out image-data just in approximately 1/30 sec. A frame-shutter reads out all data even under RTS (Random Trigger Shutter) mode.

(2) High vertical resolution

As all pixel's data are read out even under RTS mode (in 1/30 sec.), images with no deterioration in vertical resolution are obtained.

(3) Square grid pattern CCD

Pixel's in CCD are aligned in square grid pattern. This makes it easier to perform computation correctly for image processing use.

(4) External Sync.

The camera is switched over to external synchronization operation automatically when external HD signal is input.

(5) Random trigger shutter function

With a built-in RTS, the camera's CCD starts light-exposure in synchronization with external trigger signals. This function enables the camera to capture fast-moving subjects at constant position for precise image processing.

(6) Restart / Reset

Under the restart / reset mode, this model can capture images at an arbitrary timing cued by external VD signal.

(7) Multiple shutter

With this shutter, this model capture images at an arbitrary timing cued by external trigger signal, and then outputs video at an arbitrary timing cued by external VD signal.

(8) Partial-scan

Under the partial scan mode, only 1/2 or 1/4 screen center portion of image information is read out, resulting in a faster operation.

(9) Ultra-compact & light-weight camera head

The model features its ultra-compact and light-weight camera head, freeing you from your integration-space-problem. In addition, it has an excellent shock and vibration resistance.

### 3. CONFIGURATION

---

- (1) Camera body..... 1
- (2) Accessory
  - Operation Manual(Japanese) ..... 1
  - Operation Manual(English) ..... 1

### 4. OPTION UNIT

---

- (1) DC SYNC IN cable ..... Model name : CPRC3700 [2m,3m,5m,10m]
- (2) Camera adapter ..... Model name : CA130C-01
- (3) Camera-mounting kit ..... Model name : CPT8550
- (4) Camera-connector fixing hardware

\*Contact your dealer / distributor for details of option units.

\*Conformity of an option part and EMC conditions

About the conformity of EMC standard of this machine, it has guaranteed in the conditions combined with the above-mentioned option part.

When used combined parts other than specification of our company, I ask you to have final EMC conformity checked of a visitor with a machine and the whole equipment.

### 5. OPERATION MODE

---

- (1) GAIN selection (Camera rear-panel SW)

Switches sensitivity setting

(1-1) FIX ----- Factory-prefixed gain

(1-2) MANU ----- Gain is adjustable via the manual gain potentiometer (M.GAIN)

- (2) Video output mode selection (Camera rear-panel DIP SW)

Switches video format

(2-1) 1/30: 1/30s ----- Non-interlace mode

As all pixels are read out in 1/30s, you will get images with the higher V resolution.

(2-2) 1/60: 1/60s ----- 2:1 interlace MIX mode

As vertical pixels are added in readout, the sensitivity is same as that of 1/30s non-interlace mode during electronic shutter OFF. Twice greater sensitivity is obtained under shutter-speed range of 1/100 – 1/10000.

- (3) TRIG selection (Camera rear-panel DIP SW)

Switches TRIG input signal polarity used under RTS mode

(3-1) POSI ----- Positive polarity (rising edge detection)

(3-2) NEGA ----- Negative polarity (falling edge detection)

- (4) RTS (Random Trigger Shutter) exposure selection (Camera rear-panel DIP SW)

Switches light exposure mode under RTS mode

(4-1) FIX mode ----- Rear DIP SW

Exposure-time control via rear-panel DIP switch

(4-2) PULSE W mode ---- TRIG signal pulse width control

Exposure-time control via TRIG signal pulse width

(5) Shutter mode selection (Camera rear-panel DIP SW or TRIG signal IN [Automatic])

Switches shutter mode

(5-1) NOR mode ----- Normal electronic shutter

Exposure control via internal sync signal

High-speed shutter: From 1/10,000s through OFF (8 position)

(5-2) RTS mode ----- Random trigger shutter

Exposure control via ext. trigger or ext. sync input

Timing charts are shown below. (TRIG timing: Positive)

Notes: \* RTS selection is automatic with TRIG status

\*\* Neither under FIX nor PULSE W mode, RTS doesn't work if Electronic shutter speed SW is set in OFF position.

(a) Non-reset mode (Under internal sync / external sync --- Consecutive VD IN)

Exposure starts at the timing of TRIG signal IN. After each exposure is completed, the camera outputs video at each next VD IN timing.

1/30s Non-interlace

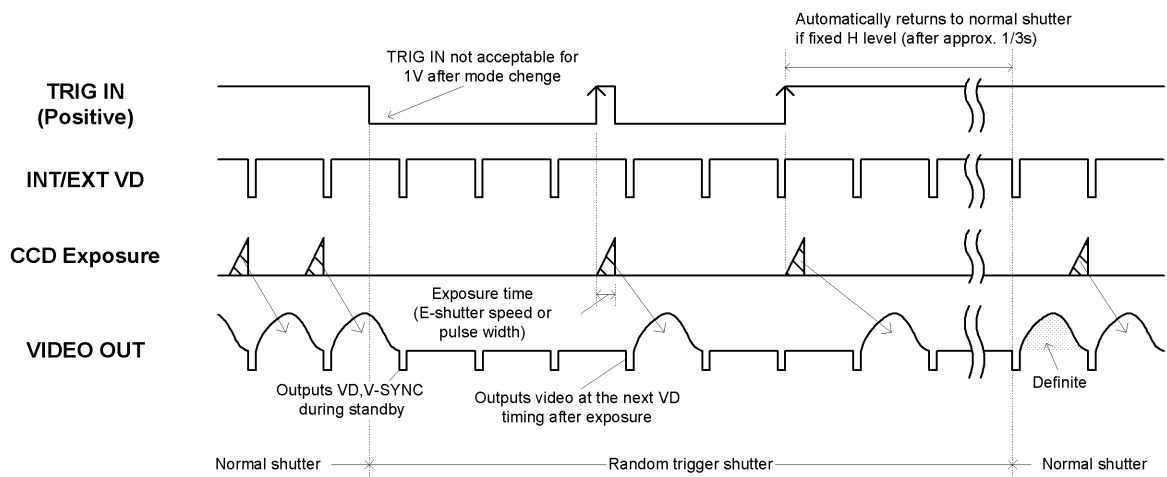

1/60s 2:1 Interlace

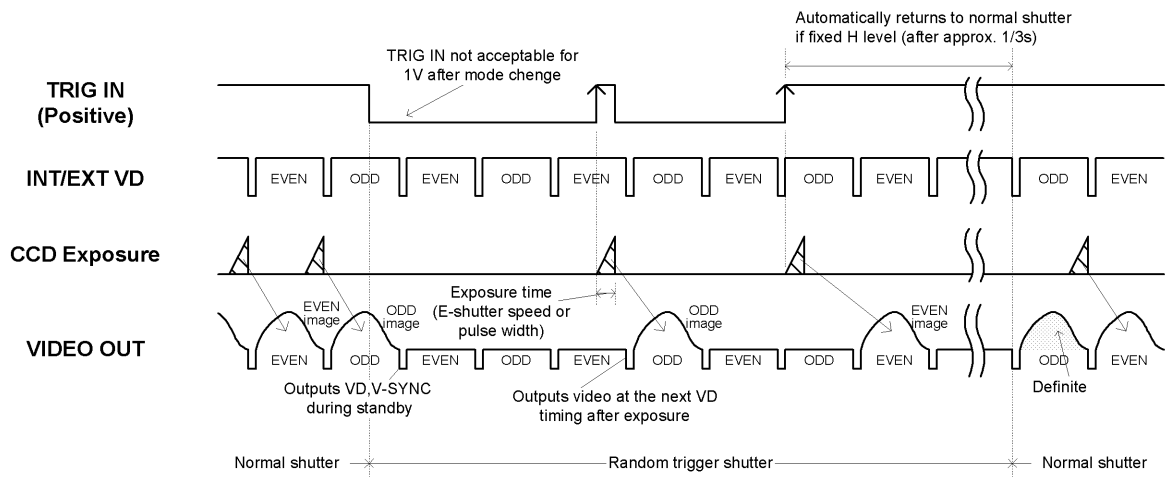

(b) Non-reset mode (Under external sync --- Single VD IN)

After TRIG IN and exposure, the camera goes into standby until next ext. VD IN.

□ 1/30s Non-interlace

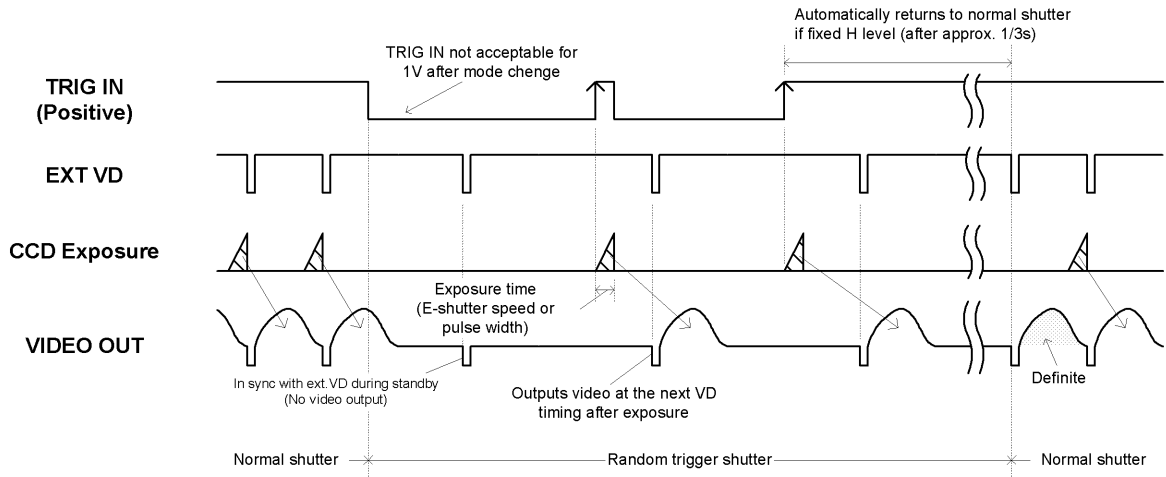

\*Don't provide ext. VD IN during exposure.

\*\* After automatic return, fix ext. VD IN at Hi.

□ 1/60s 2:1 Interlace

Video output field (ODD/EVEN) is determined by ext. VD falling edge and ext. HD phase.

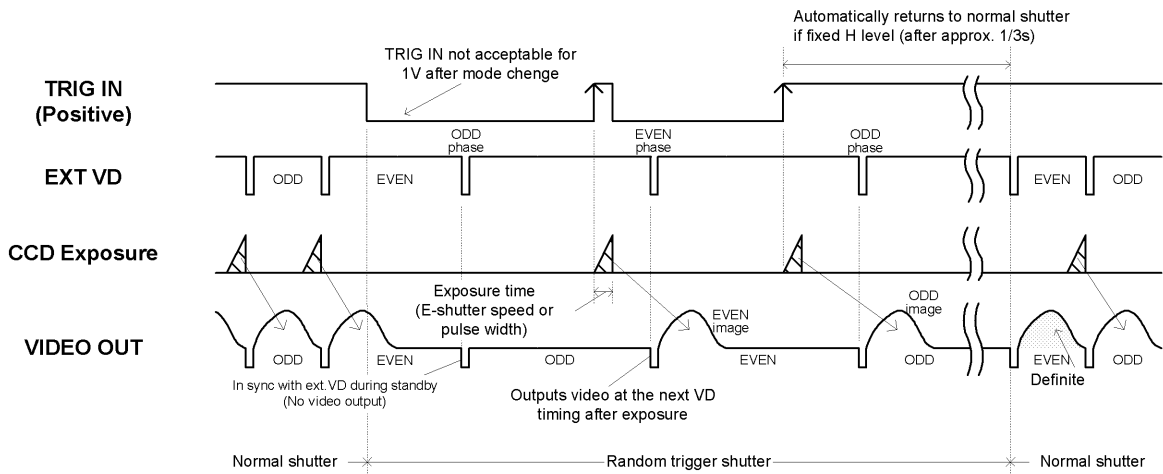

\*Don't provide ext. VD IN during exposure.

\*\* After automatic return, fix ext. VD IN at Hi.

(c) V-reset mode (Under internal sync / external sync --- No VD IN)

Exposure starts at the timing of TRIG signal IN. After each exposure is completed, the camera outputs video immediately by resetting VD. (HD is not reset)

□ 1/30s Non-interlace

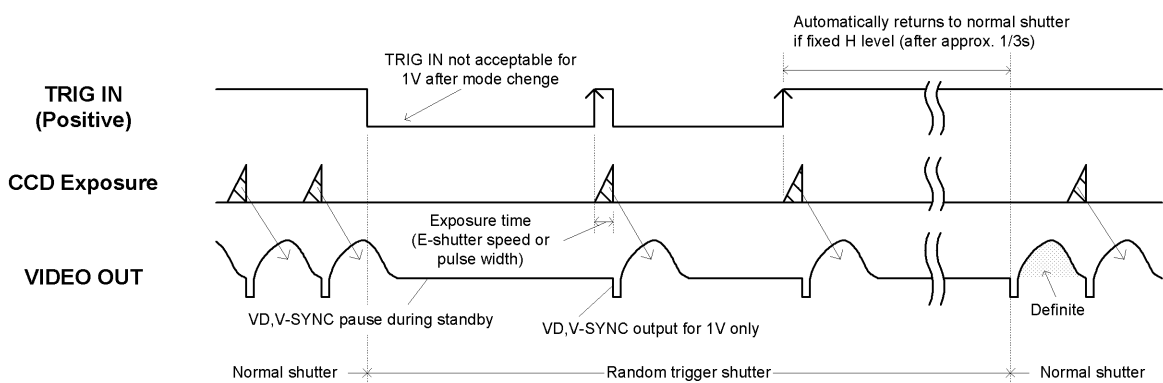

□ 1/60s 2:1 Interlace

Irrespective of TRIG IN phase, the camera always outputs ODD field image.

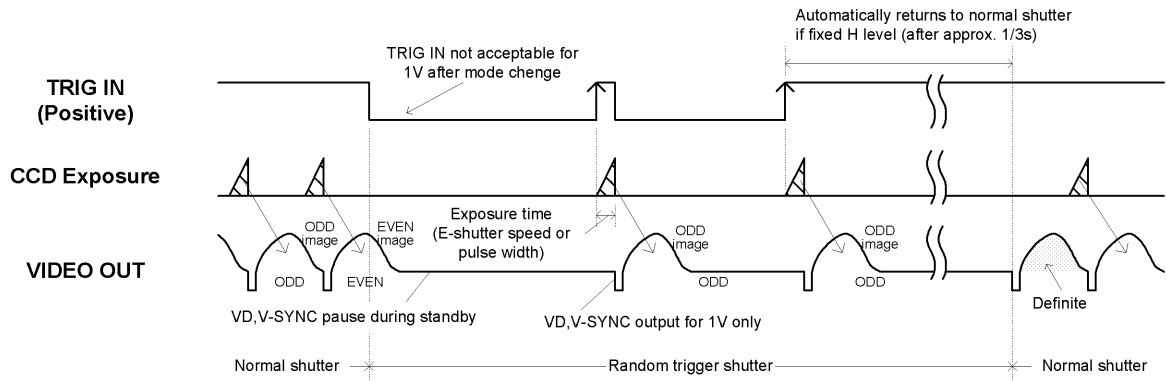

(d) SYNC reset mode (Under internal sync)

Exposure starts at TRIG signal input timing, resets HD, and outputs video immediately after exposure by resetting VD.

\* Available under FIX mode only.

□ 1/30s Non-interlace

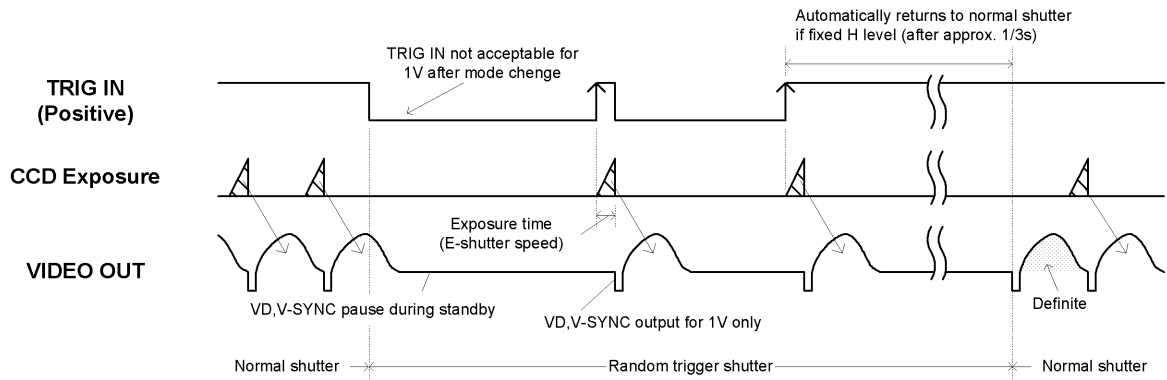

□ 1/60s 2:1 Interlace

Irrespective of TRIG IN phase, the camera always outputs ODD field image.

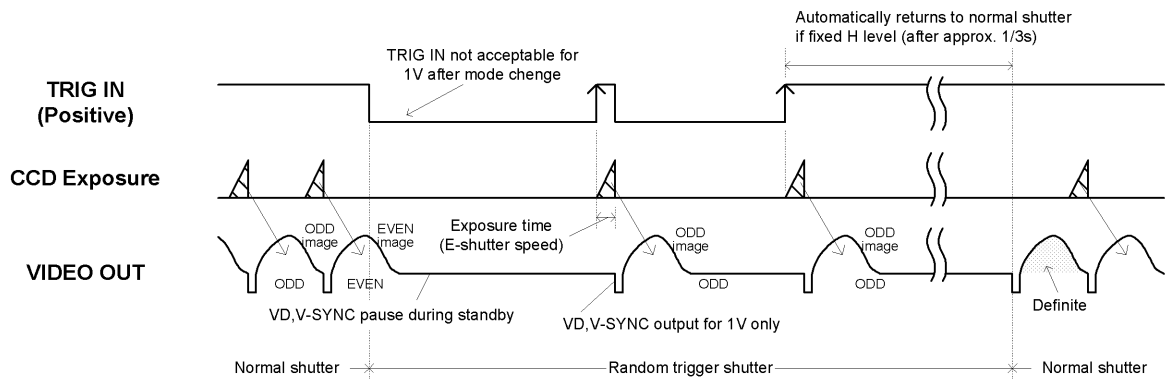

### (5-3) MULTIPLE SHUTTER mode

Multiple shutter operation is available by providing TRIG IN more than one time before ext. VD IN. (Non-reset mode, single VD, consecutive VD IN)

#### 1/30s Non-interlace

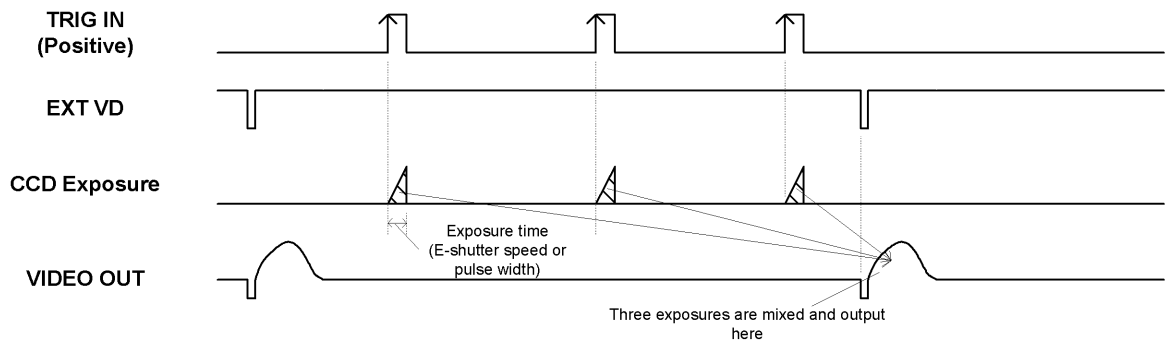

#### 1/60s 2:1 Interlace

Video output field (ODD/EVEN) is determined by ext. VD falling edge and ext. HD phase.

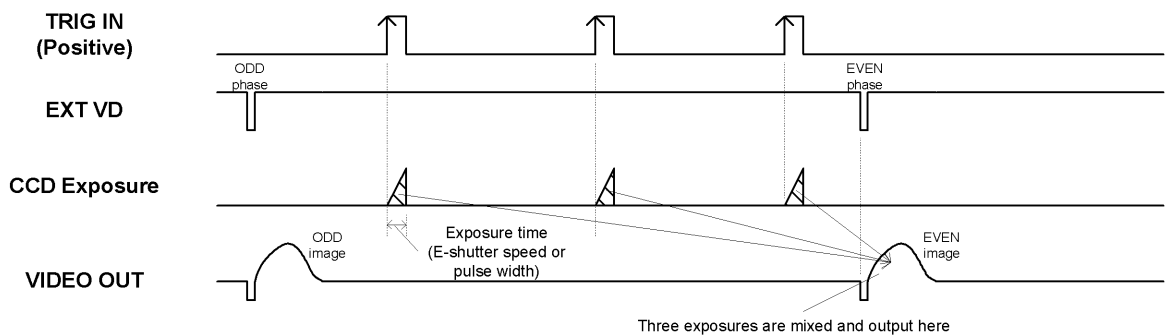

■ RTS TRIG IN notes

1/30s Non-interlace

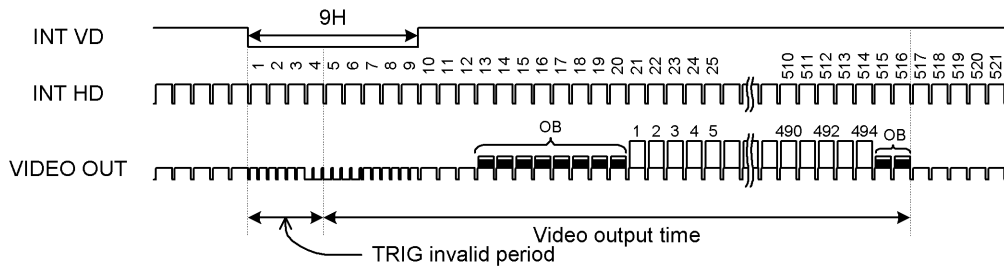

1/60s Interlace ODD Field

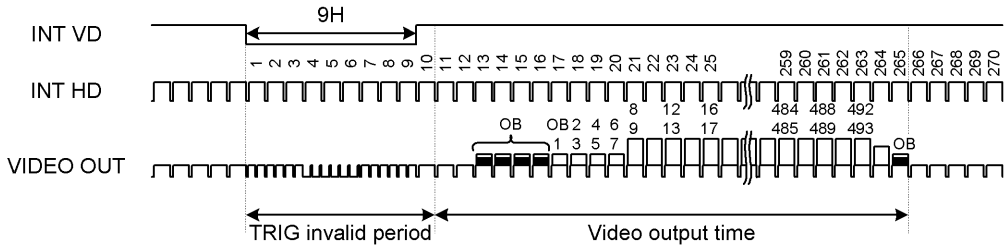

1/60s Interlace EVEN Field

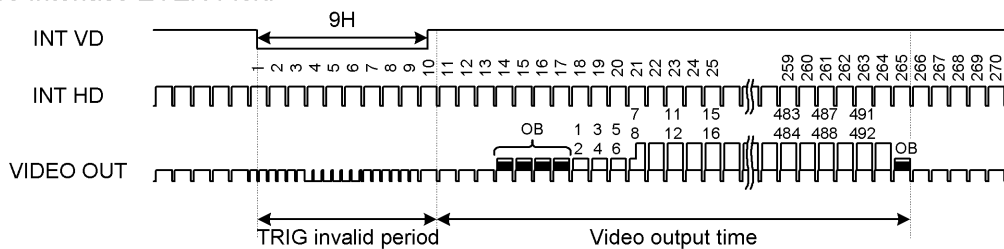

- \* TRIG becomes invalid even if TRIG (exposure start) is inputted during TRIG invalid period.
- \* An image may be affected if TRIG (exposure start) is inputted during the video output time.
- \* An image may not be outputted normally if exposure is terminated during the video output time.

■ Exposure time delay under RTS

When the RTS is active, both in FIX mode and PULSE W mode, there is a time delay of approximately 2.5 micro s until the start of exposure after the rising edge of TRIG signal (positive).

■ Exposure time under pulse width mode

Under RTS pulse mode, the exposure time is determined by the pulse width. More exactly, the actual time is the pulse width plus approximately 16.0 micro s.

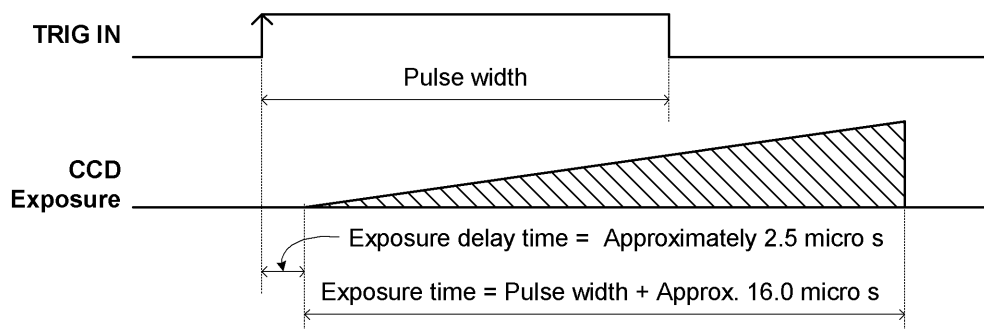

#### (5-4) Restart / Reset

The restart / reset function is available with the ext.VD signal. You can get an arbitrary slower shutter speed than normal shutter and random trigger shutter.

Here are some notes;

- \* The shutter speed (exposure time) is determined by ext. VD signal interval.
- \*\* This function is enabled when the rear-panel shutter speed DIP SW is OFF.
- \*\*\* Supply consecutive HD.

##### 1/30s Non-interlace

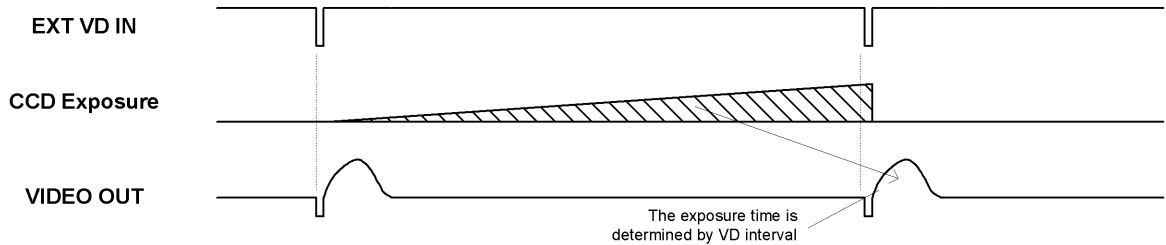

##### 1/60s 2:1 Interlace

Video output field (ODD/EVEN) is determined by ext. VD falling edge and ext. HD phase.

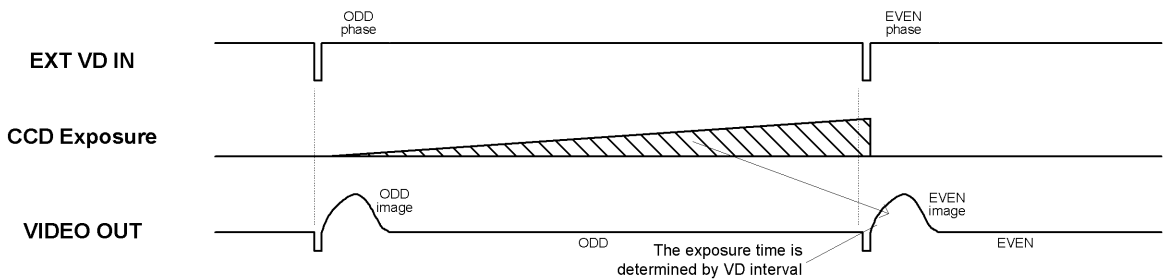

(6) Partial-scan mode selection (Camera rear-panel DIP SW)  
Switches partial-scan mode

Note: Sometimes phenomenon called as “whiteout” occurs at the top of the screen when there is strong incident light entering in the wide area of a CCD, however, this is not a malfunction. If this occurs, reduce the amount of incoming rays.

(6-1) 1/2 Partial-scan (Rear-panel SW: #7-OFF, #8-ON) --- Screen center 1/2 readout

1/30s Non-interlace

Under 1/30s non-interlace mode, only the center portion of 227H out of the total effective lines 494H (excluding BLK time) is read out. Available both under external / internal mode.

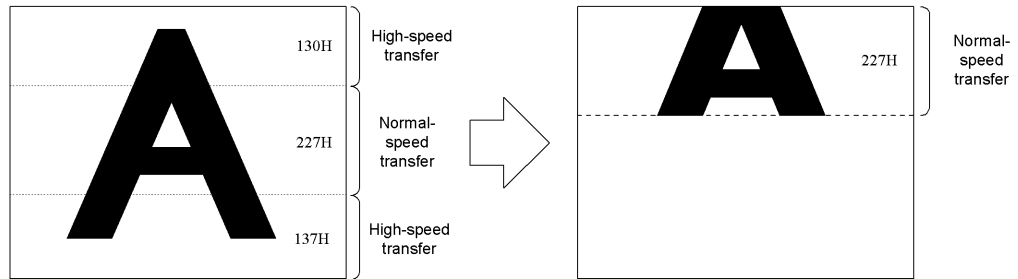

■ Under normal shutter (Electronic shutter OFF)

Notes: \* Under ext. sync, the ext. VD should be 1V = 262H.

\*\* Under normal shutter, set the rear-panel DIP SW #5, #6 in OFF.

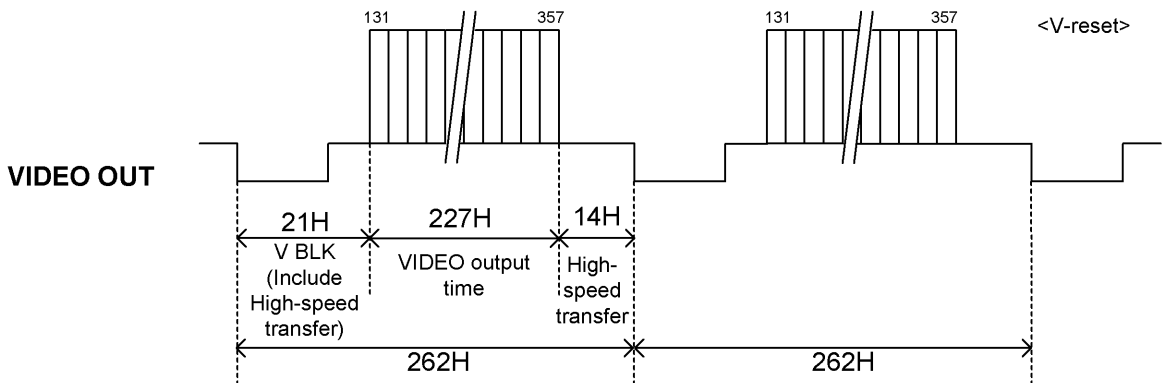

■ Under other shutter modes

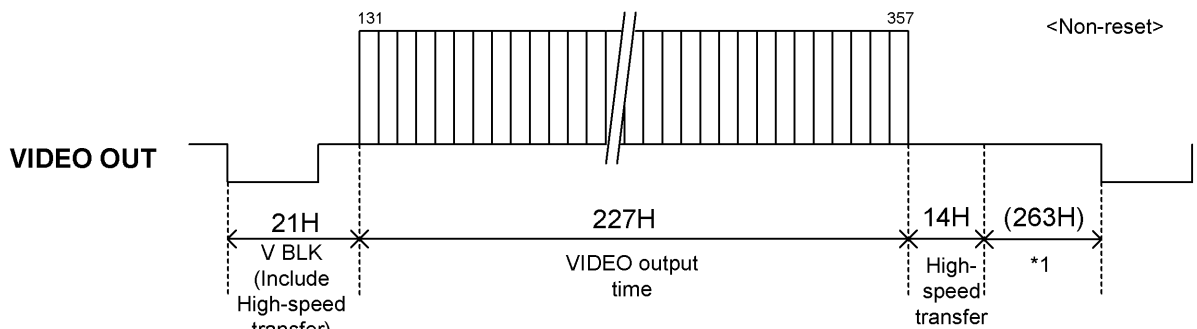

\*1: Arbitrary under ext.sync

□ 1/60s 2:1 Interlace

Under 1/60s interlace mode, only the center portion of 207H out of the total effective lines 485H (excluding BLK time) is read out. Available both under external / internal mode.

ODD Field

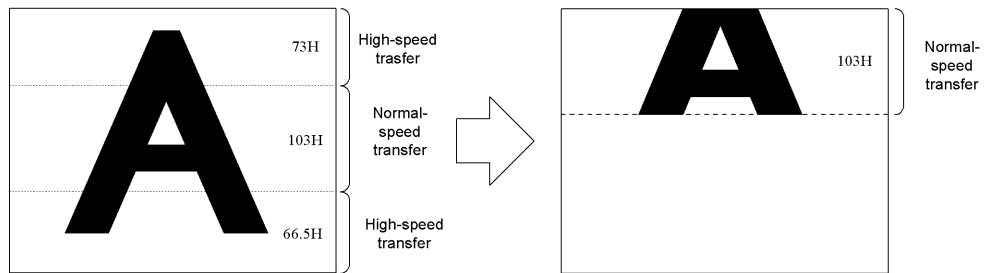

EVEN Field

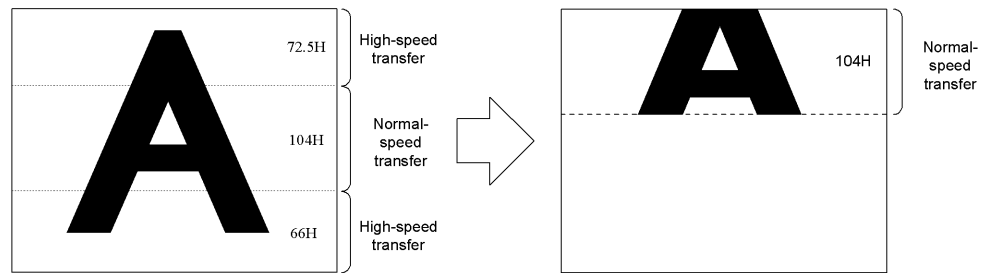

■ Under normal shutter (Electronic shutter OFF)

Notes: \* Under ext. sync, the ext. VD should be  $1V = 131.5H$ .

\*\* Under normal shutter, set the rear-panel DIP SW #5, #6 in OFF.

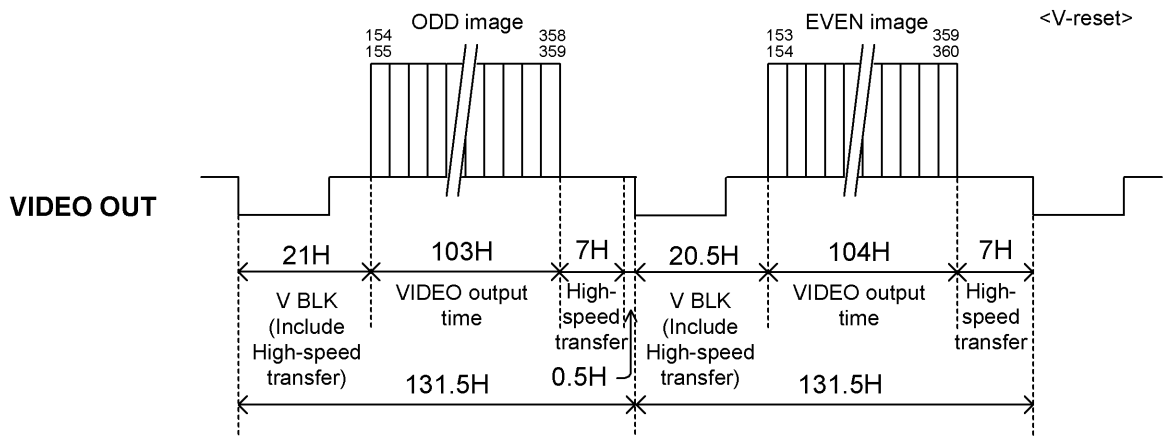

■ Under other shutter modes

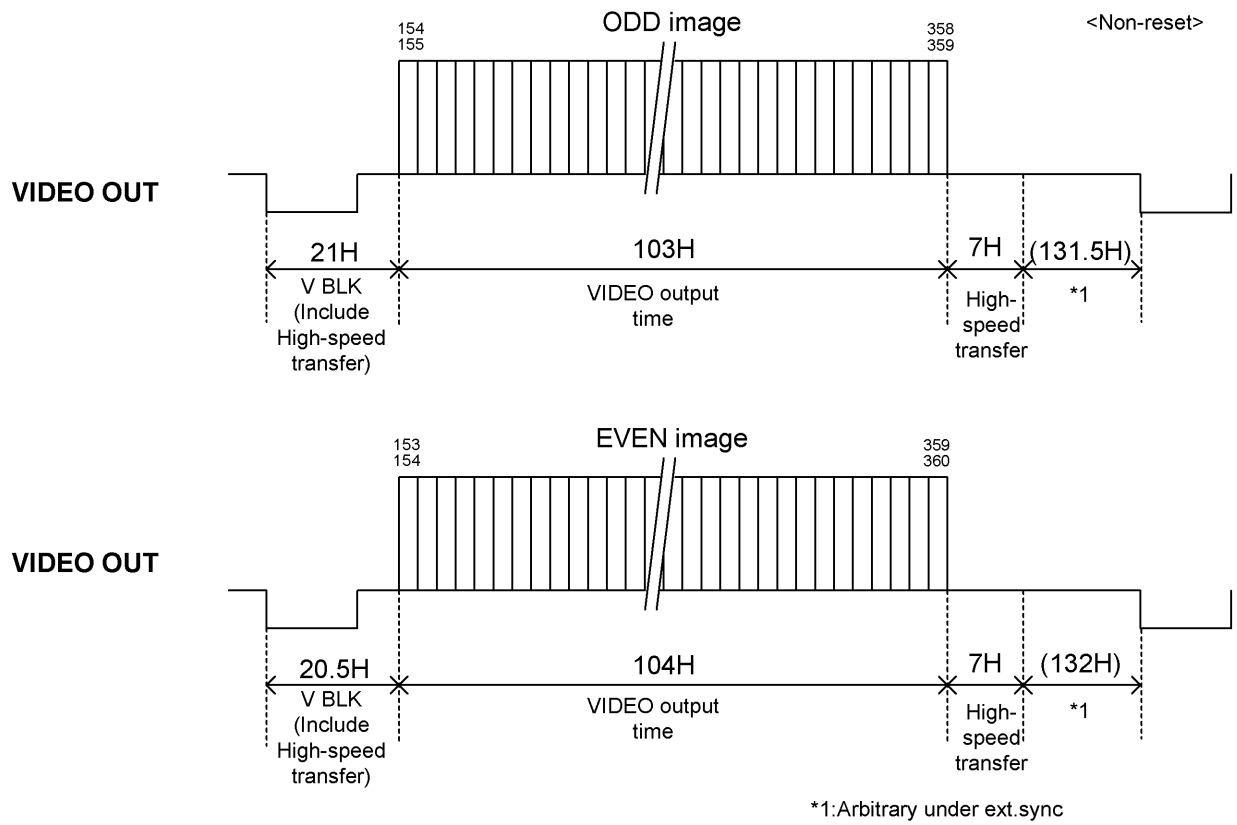

(6-2)1/4 Partial-scan (Rear-panel SW: #7-ON, #8-ON) --- Screen center 1/4 readout

□ 1/30s Non-interlace

Under 1/30s non-interlace mode, only the center portion of 81H out of the total effective lines 494H (excluding BLK time) is read out. Available both under external / internal mode.

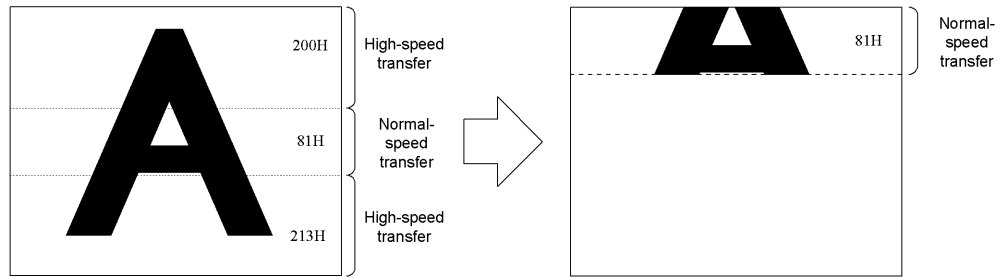

■ Under normal shutter (Electronic shutter OFF)

Notes: \* Under ext. sync, the ext. VD should be 1V = 131H.

\*\* Under normal shutter, set the rear-panel DIP SW #5, #6 in OFF.

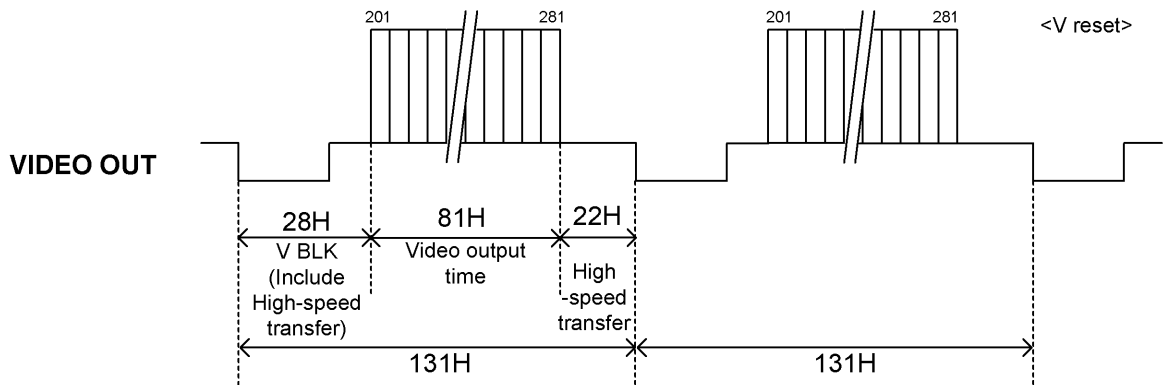

■ Under other shutter modes

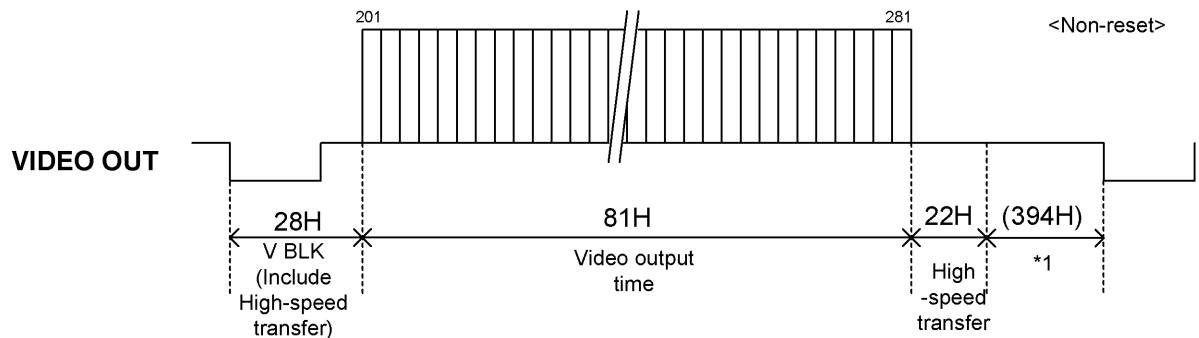

\*1:Arbitrary under ext.sync

□ 1/60s 2:1 Interlace

Under 1/60s interlace mode, only the center portion of 61H out of the total effective lines 485H (excluding BLK time) is read out. Available both under external / internal mode.

ODD Field

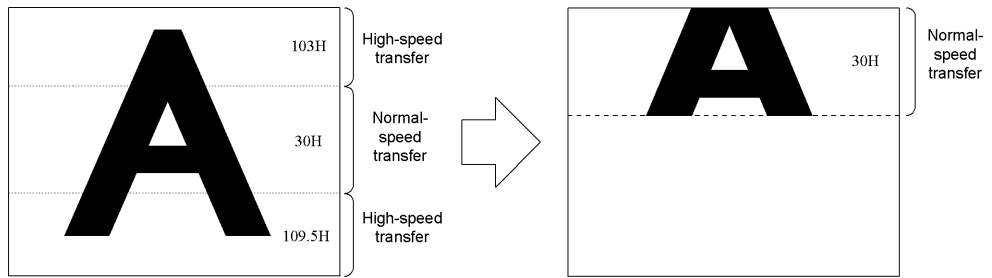

EVEN Field

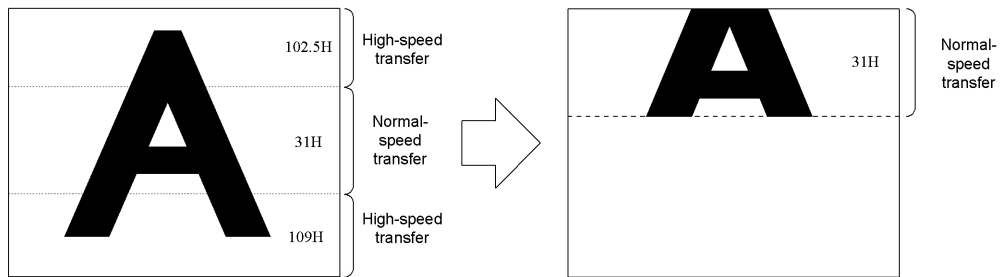

■ Under normal shutter (Electronic shutter OFF)

Notes: \* Under ext. sync, the ext. VD should be 1V = 65.5H.

\*\* Under normal shutter, set the rear-panel DIP SW #5, #6 in OFF.

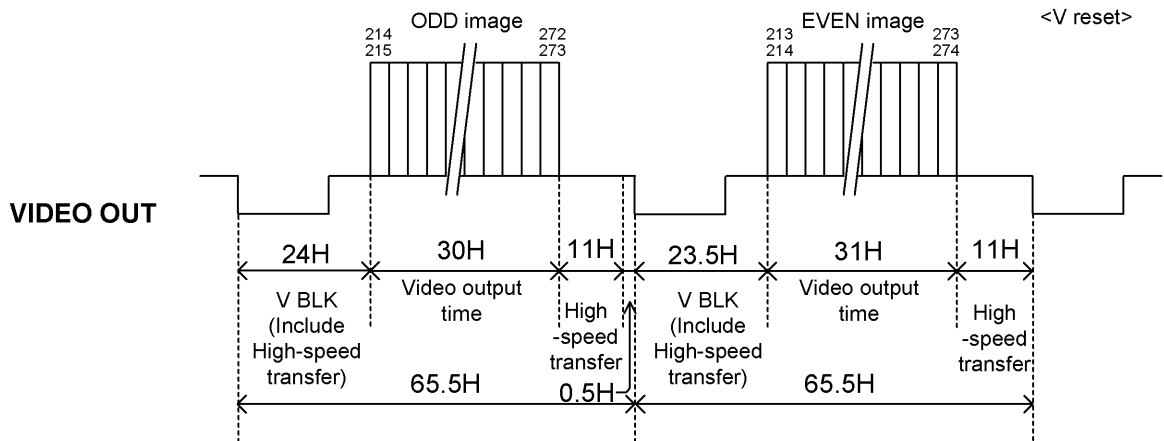

■ Under other shutter modes

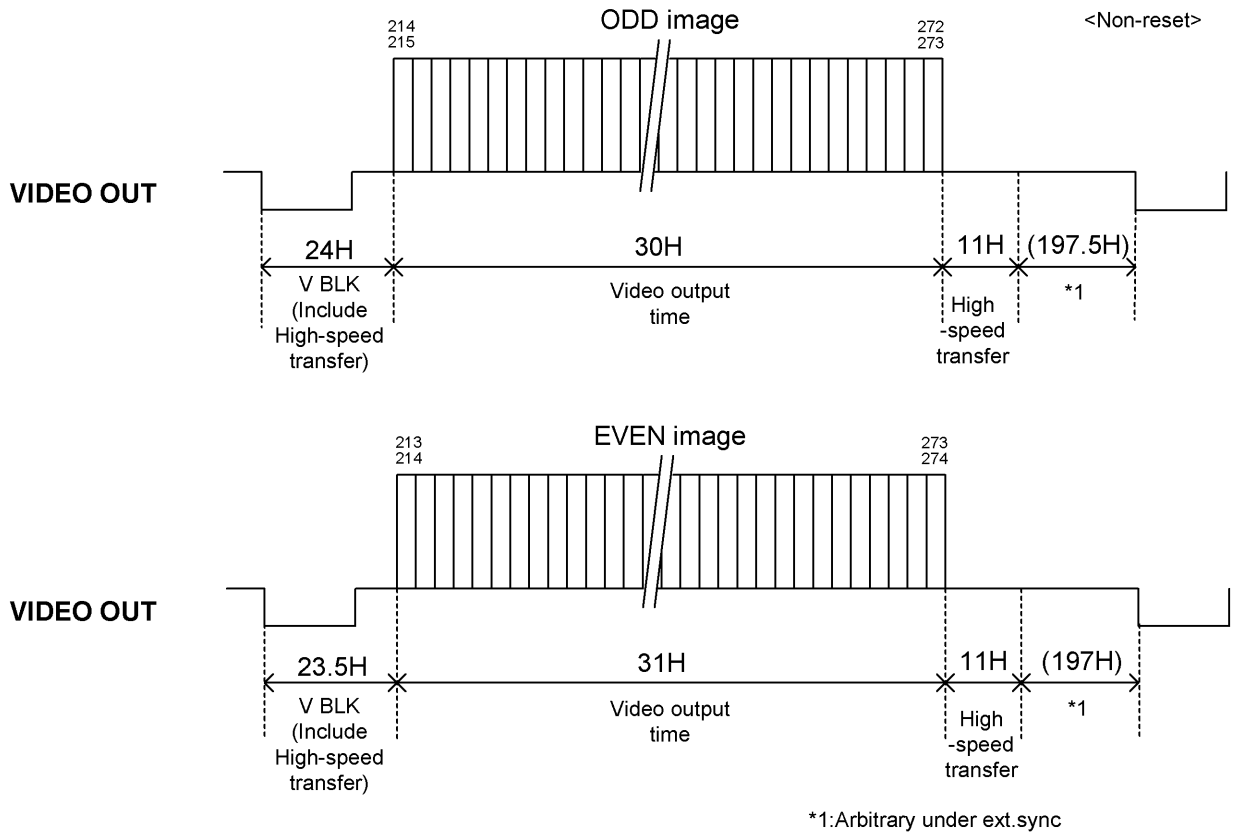

## 6. SPECIFICATIONS

---

### [Basic spec]

(1) Image sensor	All Pixel's Data Read-out Interline CCD
Total pixels	692(H) x 504(V)
Active pixel	659(H) x 494(V)
Video output pixels	648(H) x 494(V) (Under non-interlace)
Scanning area	4.88(H) x 3.66(V) mm (=Equivalent to 1/3 type CCD size)
Unit cell size	7.4(H) x 7.4(V) micro m (Square-grid array)
(2) TV system	Conforming to EIA
(3) Scanning lines	525 lines
(4) Interlace	1/30s Non-interlace mode 1/60s 2:1 Interlace mode Switching via rear-panel DIP SW
(5) Sync system	Internal/External automatic switch-over
(6) Aspect ratio	4:3
(7) Video output	VS 1.0V(p-p) / 75 $\Omega$ , DC coupled, 1 line
(8) Resolution	485 TV lines(H) 485 lines (350 TV lines)(V)
(9) S/N	Standard: 52dB(p-p)/rms (Initial factory setting)
(10) Illumination	Standard 400 lx (F8) Minimum 2 lx (F1.4) (GAIN MAX, Approx. 50% video output)
(11) Gain	FIX (Fixed) gain: Factory-shipped preset level MANU (Manual) gain: Setting through GAIN VR FIX / MANU switching via rear-panel DIP SW
(12) Gamma correction	Gamma = 1 (Fixed)
(13) White-clip level	Approx. 860mV(p-p) (Excluding SYNC)
(14) Power source	DC12V $\pm$ 10% Ripple voltage: 50mV(p-p) or less
(15) Power consumption	Approx. 1.3W

### [Internal sync spec]

(1) Base clock frequency	12.273MHz (1CLK) $\pm$ 200ppm
(2) H sync frequency	15.734kHz (1H = 780CLK)
(3) V sync frequency	29.97Hz (Under non-interlace) 59.94Hz (Under 2:1 interlace)

**[External sync spec]**

- (1) Ext. sync input signal HD/VD
- (2) Input level From 2 through 4V (p-p)
- (3) Input impedance 75-ohm / High impedance 10k-ohm (switching via rear-panel SW)  
(Initial factory setting: High)
- (4) Interlace 1/30s non-interlace or 1/60s 2:1 interlace
- (5) Polarity Negative
- (6) Pulse width HD: 6.4 +/- 2 micro s (LOW)  
VD: From 250 through 800 micro s (LOW)
- (7) Repeating frequency  $f_H = 15.734\text{kHz} \pm 1\%$   
 $f_V = f_H/262.5$  or  $f_H/525$
- (8) Phase difference HD/VD: 0 +/- 5.0 micro s,  $1/f_H/2 \pm 5.0$  micro s

**[Shutter trigger spec]**

- (1) Input level Exposure-starting-cue signal in random trigger shutter mode  
LOW level: From 0 through 0.5V(p-p)  
HIGH level: From 4 through 5V(p-p)
- (2) Input impedance High impedance (10k-ohm)
- (3) Capture timing Rising edge detection (Positive) / Falling edge detection (Negative)  
(Switching via rear-panel DIP SW)  
(Initial factory setting: Rising edge)
- (4) Pulse width Minimum 4 micro s  
Maximum 1/4s

**[Electronic shutter spec]**

- (1) Normal shutter Shutter-speed setting via rear-panel SW (Initial: OFF)  
8 steps switch-able (= OFF, 1/100s, 1/250s, 1/500s, 1/1000s, 1/2000s, 1/4000s, 1/10000s)

(2) RTS

(a) Operation mode

No.	Reset	Exposure	Sync
1	Non-reset	Rear SW (FIX mode)	Internal
2			Consecutive HD / Consecutive VD IN
3			Consecutive HD / Single VD IN
4		TRIG pulse width (PULSE width mode)	Internal
5			Consecutive HD / Consecutive VD IN
6			Consecutive HD / Single VD IN
7	V-reset	Rear SW (FIX mode)	Internal
8			Consecutive HD IN
9	SYNC reset		Internal
10	V reset	TRIG pulse width (PULSE width mode)	Internal
11			Consecutive HD IN

Notes : \* RTS mode automatically switches over through TRIG IN

\*\*RTS disabled under Electronic shutter OFF

(b) Multiple shutter

Multiple shutter via ext. trigger signal and ext. VD signal

Notes : \* Operation like No.3, 6 above

- (3)Restart / Reset Restart / reset available via ext. VD signal  
 (Switching via rear panel DIP SW, Initial OFF)  
 Notes : \* The exposure-time (shutter-speed) is determined by ext.  
 VD interval.  
 \*\* Enabled when rear-panel DIP SW OFF.  
 \*\*\*Provide Consecutive HD.

**[Mechanical spec]**

- (1) External dimension 29 x 29 x 39.5(D) mm (Not including protrusion)  
 Refer to the attached external view drawing  
 (2) Weight Approximately 50g  
 (3) Lens mount C mount  
 (4) GND / insulation Circuit GND - Chassis electrically conducted

**[Ambient condition]**

- (1)Environment condition  
 Performance guaranteed Temperature: From 0 through 40 °C  
 Humidity: From 30 through 90 % (No condensing)  
 Operation guaranteed Temperature: From -5 through 50 °C  
 Humidity: From 10 through 90 % (No condensing)  
 Storage Temperature: From -20 through 60 °C  
 Humidity: From 10 through 90 % (No condensing)  
 (2)EMC conditions (Electro-Magnetic Compatibility)  
 EMI (Electro-Magnetic Interference)  
 EN50081-2 (Examination level EN55011-A) Conformity  
 EMS (Electro-Magnetic Susceptibility)  
 EN61000-6-2 Conformity

**\*Conformity of EMC conditions**

About the conformity of the EMC standard of this machines, it has guaranteed in the conditions combined with the option part of 4th clause.

When used combining parts other than specification of our company, I ask you to have final EMC conformity checked of a visitor with a machine and the whole equipment.

**[Connector pin assignment]**

(1) Compatible connector HR10A-10P-12S (Supplied by HIROSE ELEC.)

(2) Pin assignment

Pin No.	Signal
1	DC12V GND
2	DC12V
3	VIDEO GND
4	VIDEO OUT
5	HD GND
6	HD IN
7	VD IN
8	TRIG GND
9	TRIG IN
10	GND
11	DC12V
12	VD GND

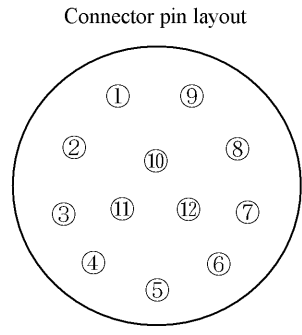

12 pin male

Picture Rear-panel camera connector

Notes : \*Before connecting / disconnecting the connector, make sure the camera power is OFF.

\*\*For board connection, check compatibility.

## [Switch setting]

### (1) CCU rear-panel DIP SW

No.	Function	OFF	ON
1	E-shutter-speed (SHUT)	See shutter-speed table (Table 1)	
2			
3			
4	Video output mode (VIDEO)	1/30s non-interlace	1/60s interlace
5	Shutter mode (SMODE)	See shutter-mode table (Table 3)	
6			
7	Partial scan (PART)	See partial-scan table (Table 2)	
8			
9	TRIG polarity (TRIG)	Positive (Rising edge)	Negative (Falling edge)
0	RTS Exposure (EXP)	FIX mode	PULSE W mode

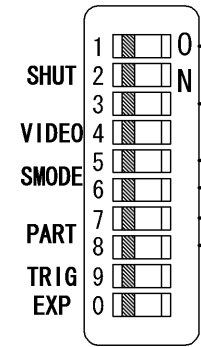

Notes: \*Initial factory setting: All OFF

\*\*Set No.9 OFF when TRIG IN OPEN.

(Table 1) Electronic shutter-speed

Shutter-speed	No.1	No.2	No.3
OFF	OFF	OFF	OFF
1/100s	ON	OFF	OFF
1/250s	OFF	ON	OFF
1/500s	ON	ON	OFF
1/1,000s	OFF	OFF	ON
1/2,000s	ON	OFF	ON
1/4,000s	OFF	ON	ON
1/10,000s	ON	ON	ON

(Table 2) Partial-scan

Partial scan	No.7	No.8
OFF	OFF	OFF
Not acceptable	ON	OFF
1/2 partial	OFF	ON
1/4 partial	ON	ON

Notes : \*Don't set Electronic shutter-speed in OFF under RTS mode.

(Table 3) Shutter-mode

Shutter mode		No.5	No.6	SYNC	
Random trigger	V reset	OFF	OFF	Internal sync	
	SYNC reset	ON	OFF		
	Non-reset	OFF	ON		
Not acceptable		ON	ON		
Random trigger	Non-reset (Multiple shutter)	OFF	OFF	Single VD	Ext. sync HD IN
	Non-reset	ON	OFF	Consecutive VD	
	V reset	OFF	ON	No VD	
Restart / Reset		ON	ON	Single VD	

Notes : \* Under normal shutter mode partial-scan, set No.5, 6 in OFF.

\*\*Under PULSE W mode, SYNC reset is disabled.

### (2)CCU rear-panel SW

Function	SW	Selected Function
Ext. SYNC IN impedance (HD/VD)	HIGH	HIGH impedance (Initial factory setting)
	75Ω	75Ω
GAIN selection (GAIN)	F	Factory-set GAIN
	M	Manual GAIN adjustable via GAIN potentiometer

### [Relative Spectrum Response]

\*Including lens characteristics, Excluding light source characteristics

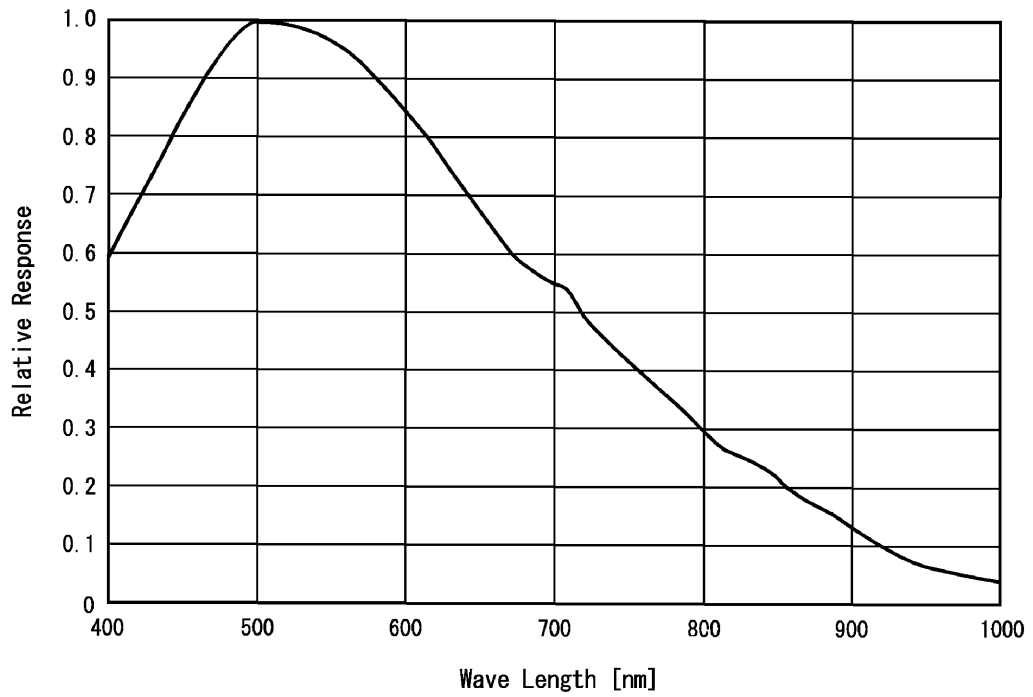

### [Optical black characteristics]

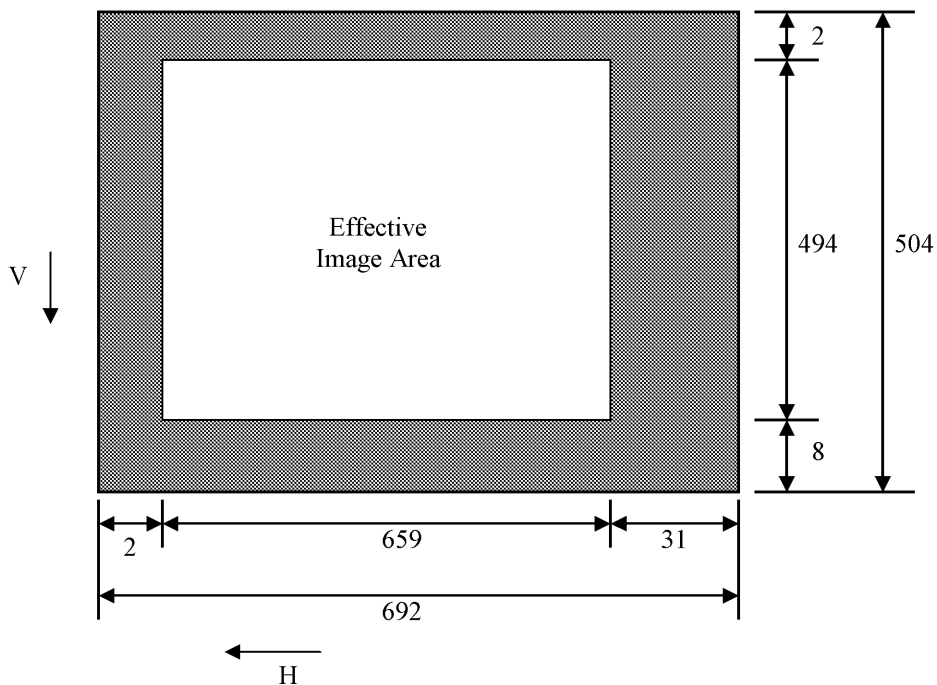

Total pixels : 692(H) x 504(V)  
Effective pixels : 659(H) x 494(V)  
Optical black  
Horizontal : 2pixels --- 31pixels  
Vertical : 8pixels --- 2pixels

# 7. TIMING CHART

## (1) H rate timing

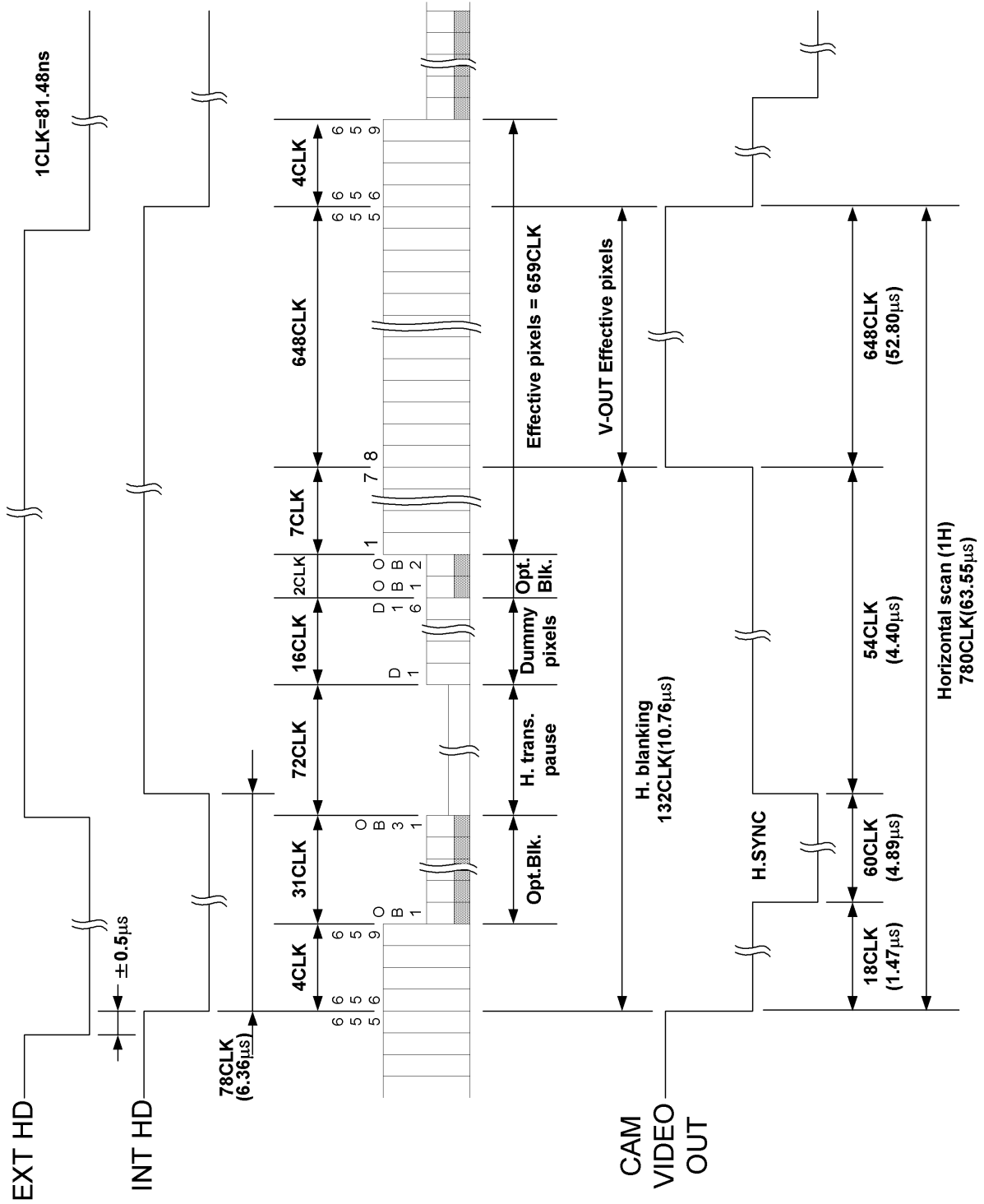

(2) 1/30s Non-interlace mode

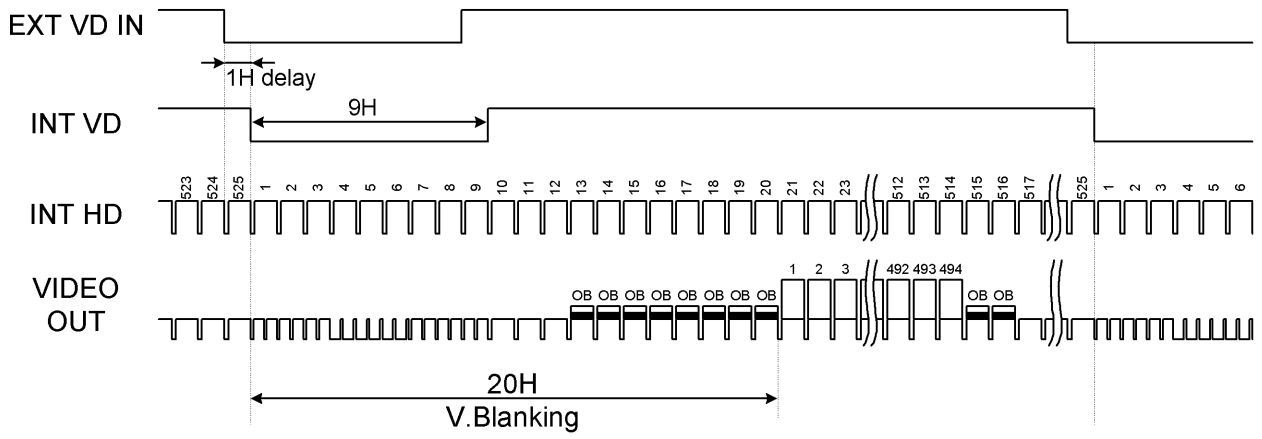

Ext. VD – Ext. HD phase difference

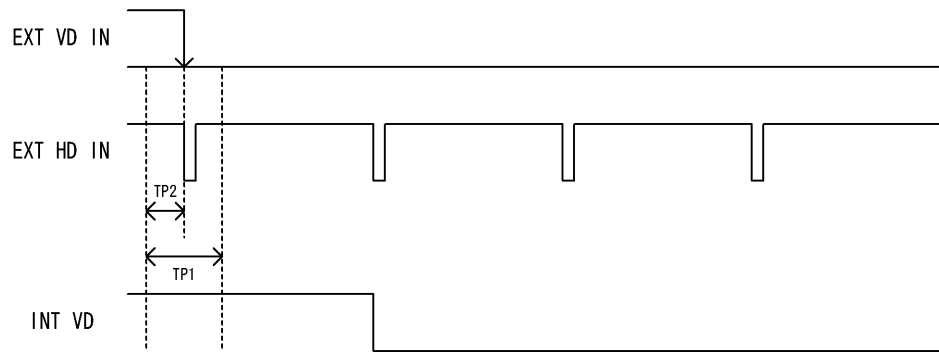

TP1 : 10.0 us  
TP2 : 5.0 us

(3) 1/60s 2:1 Interlace mode

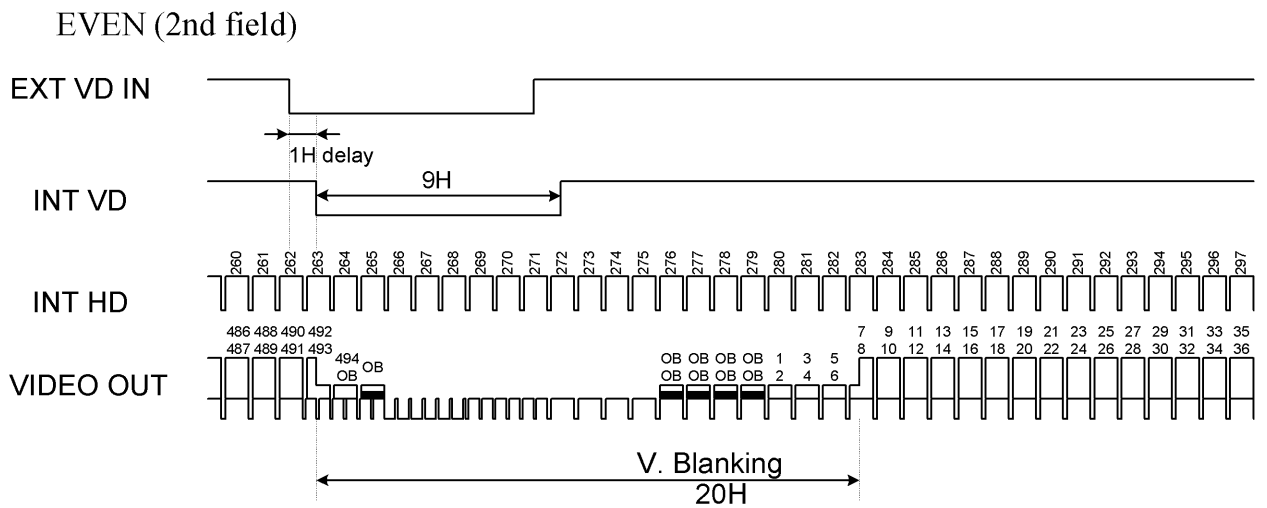
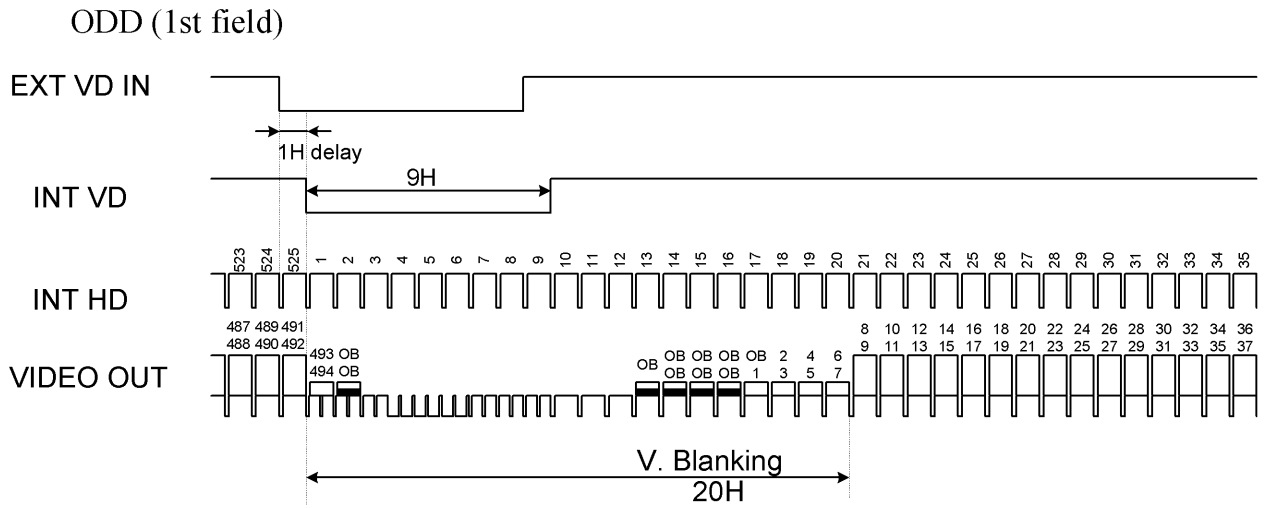

Ext. VD – Ext. HD phase difference

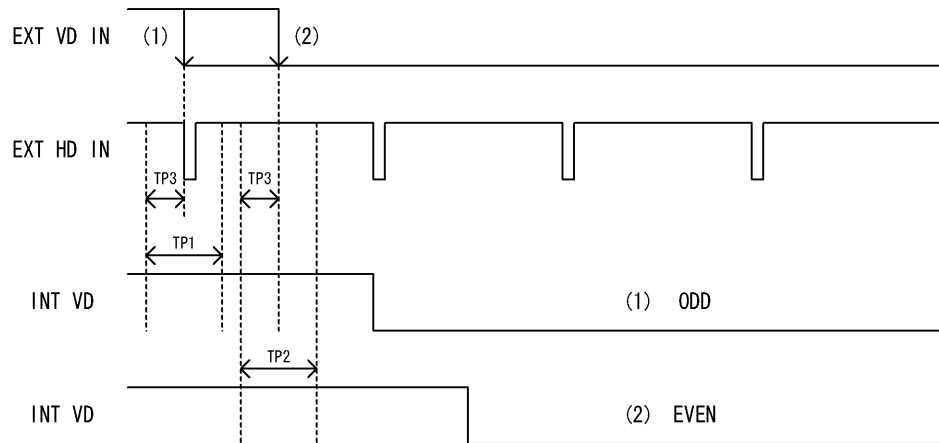

TP1 : ODD reset range      10.0 us  
 TP2 : EVEN reset range     10.0 us  
 TP3 : 5.0 us

## 8. EXTERNAL-VIEW DRAWING

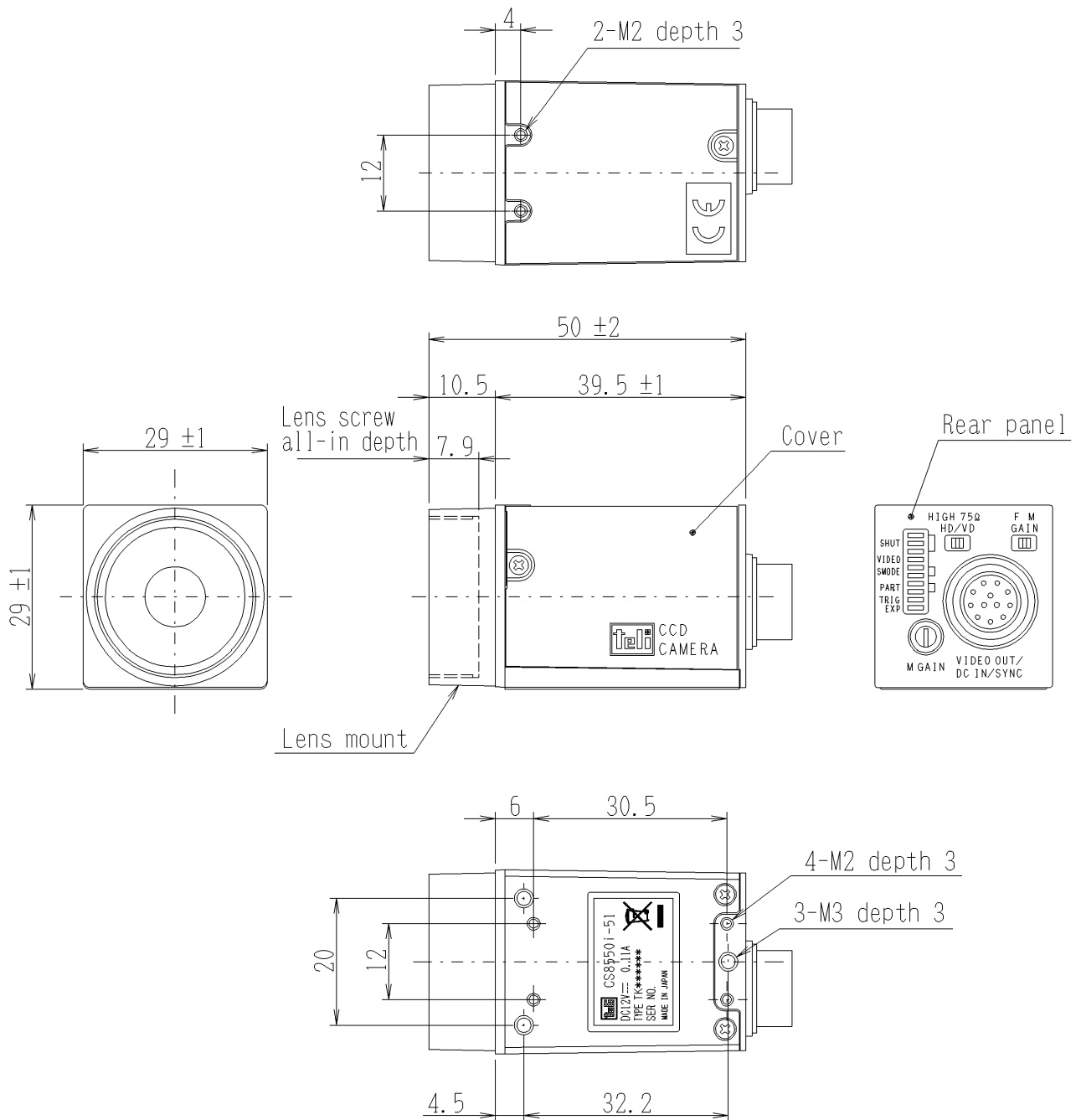

### Specification

Material	Lens-mount, Rear panel : Aluminium die-cast
	Cover : Anticorrosion aluminum alloy
Processing	Lens-mount, Rear panel : Cation coating
	Cover : Leather satin coating



## **TOSHIBA TELI CORPORATION**

---

**Head Office:** 7-1, 4 chome, Asahigaoka, Hino-shi, Tokyo, 191-0065, Japan  
(Overseas Sales Department)  
Phone: +81-42-589-8771 Fax: +81-42-589-8774

**URL:** <http://www.toshiba-teli.co.jp>

---

The design and specification is subject to change without notice.