



CCD Color Camera CS6910CL Specification

Contents

1.	Overview	1
2.	Features	1
3.	Components	1
4.	Options	2
5.	Specifications	2
6.	Interfaces	6
7.	Dip Switch Settings	8
8.	CAMERA LINK Serial Control	10
9.	Timing Charts	17
10.	Outline Drawing	19
11.	Cases for Indemnity (Limited Warranty)	20
12.	Restriction for Use	21

TOSHIBA TELI CORPORATION

This document is printed on recycled paper.

D4134419B

1. Overview

This camera is a CAMERA LINK output, integral-type high frame rate color camera adopting CCD with 630,000 effective pixels.

2. Features

(1) High resolution

CCD with 630,000 effective pixels is adopted. Image processing embedded in the camera allows high-resolution 24-bit color images in a SXGA (1280 x 960) size.

(2) Full frame output

All pixel information is outputted through progressive scan even in random trigger shutter.

(3) High frame rate

SXGA (1280 x 960) images can be outputted in high speed; 30 frames/sec.

(4) Random trigger shutter function

The random trigger shutter function provides images in any timing by input of an external trigger signal.

(5) CAMERA LINK I/F

The CAMERA LINK standard is adopted for video output and camera control interfaces. CAMERA LINK-compatible frame grabber board allows high-speed transfer of images to PC and camera control from PC.

(6) Compact and lightweight

This camera is compact and lightweight with outside dimensions of 54(W) x 43(H) x 59(D) mm and weight of approx. 150 g. It is easy to integrate into an industrial equipment.

3. Components

- | | |
|------------------------------------|---|
| (1) Main camera body: | 1 |
| (2) Instruction Manual (Japanese): | 1 |
| (3) Instruction Manual (English): | 1 |

4. Options

- | | |
|--|--------------------|
| (1) Power cable (2 m , 3 m , 5 m) | CPRC3700-** |
| (2) CAMERA LINK cable (2 m , 3 m , 5 m , 10 m) | 14B26-SZLB-***-0LC |
| (3) Tripod mount | CPT4000CL |
| (4) Camera adapter | CA150, CA130C (*1) |

(*1) CA150 does not support trigger input. To use the external trigger function, CA130C is required.

[Compliance with EMC standard]

The compliance of this device to the EMC standard is guaranteed in the condition with the optional parts above. If you use this product combined with parts other than specified by us, the customer should check the EMC compliance of the entire machine/device.

5. Specifications

- | | |
|---------------------------------|---|
| (1) Image sensor | CCD |
| - Readout method | All pixel simultaneous read/horizontal 2-time read |
| - Total number of pixels | 680 (H) x 504 (V) x 2 (685,440 pixels) |
| - Number of effective pixels | 648 (H) x 486 (V) x 2 (629,856 pixels) |
| - Unit cell size | 3.8 x 3.8 μ m |
| - Area size of effective pixels | 3.4992 (H) x 2.6244 (V) mm |
| - Chip size | 5.0 (H) x 4.53 (V) mm (1/4.2 type) |
| - Color filter | G square grid array, R/B interpolation point sequential |
| - Driving frequency | 24.5454 MHz |

- (2) Frame rate- scan mode

Mode	Output method	Frame rate	Scan mode	Number of pixels in output image
SXGA 30fps	Digital	30 frames/sec	Progressive	1280(H) x 960(V)
SXGA 15fps	Digital	15 frames/sec	Progressive	1280(H) x 960(V)
VGA 30fps	Digital	30 frames/sec	Progressive	640(H) x 480(V)
NTSC	Analog	30 frames/sec	Interlace	640(H) x 480(V)

- | | |
|--------------------------|---|
| (3) Sync system | Internal synchronization |
| (4) Aspect ratio | 4:3 |
| (5) Subject illumination | |
| - Standard | 3000lx, F8, 5100K (SXGA 30 fps, shutter speed: 1/30 s) |
| - Minimum | 30lx, F1.4 (SXGA 30 fps, shutter speed: 1/30 s, γ : 0.45, Gain: +6 dB, Video level: 50%) |

CCD color camera CS6910CL Specification (Rev.B)
The contents described in this document may be changed without prior notice.

(6) Video output

- Digital output
 - Output method CAMERA LINK standard compatible (8 bit each for RGB, max. 49.09 MHz)
- Analog output
 - Output method NTSC standard compatible
 - Output level VBS: 1.0V(p-p)/75 Ohm

* Digital output and analog output cannot be outputted simultaneously.

(7) S/N

50 dB (Edge enhancement: OFF, γ : 1, based on our bench mark)

(8) Trigger input (random trigger shutter)

- Input level Low: 0 to 0.5V
High: 2.0 to 5.0V
- Polarity Positive/negative bipolar
- Input impedance High impedance

* Trigger signal input via CAMERA LINK I/F is also possible.

(9) Output signal

- HD
 - Output level 4.0V (p-p)
 - Polarity Negative
 - Repeating frequency 31.47 kHz (SXGA 30 fps, VGA 30 fps)
15.73 kHz (SXGA 15 fps)
- VD
 - Output level 4.0V (p-p)
 - Polarity Negative
 - Repeating frequency 29.97 Hz (SXGA 30 fps, VGA 30 fps)
14.98 Hz (SXGA 15 fps)
- WEN
 - Output level 4.0V (p-p)
 - Polarity Positive
 - Pulse width 1H

(10) Electronic shutter

- Auto exposure
 - Detection area Can be selected from Wide/Small (average in the center/spot)
 - Tracking range 1/15000 to 1/30s

* Auto exposure in random trigger shutter is disabled.
- Manual setting
 - Shutter speed 1/15000 to 4s (SXGA 30 fps, VGA 30 fps)
1/10000 to 4s (SXGA 15 fps)
1/15000 to 1/60s (NTSC)
 - Setting precision Set by a/b[s]
a:1 to 8 and b:1 to 15000 can be set for 1 step

* When exposure time is set up for a long time, white spots and the unevenness of a highlight portion might occasionally be observed on screen. This phenomenon is due to the characteristics of the CCD image sensor.

(11) Gain control

Analog pre-gain control available

- Control range 0 to + 6 dB

(12) White balance

- Full auto
 - Operation method Area-by-area white determination tracking method
 - Split area Evenly split to 8x8 in entire area
 - Effective color temperature 2400K to 6500K
 - Effective area All white recognition area

* Full auto WB in random trigger shutter is disabled.
- One-push auto
 - Effective color temperature 2400 to 9000K
 - Effective area Entire area

* One-push auto WB in random trigger shutter is disabled.
- Manual
 - Setting color temperature 3000, 3700, 4000, 4500, 5500, 6500K (Preset settings)
R, B gains can be set separately

(13) γ characteristics	0.45/0.65/1.0/User setting (1 type)
(14) Edge enhancement	Intensity 3 levels and Enhancement OFF can be set. Horizontal-vertical both edge enhancement
(15) Resolution	
- Horizontal resolution	600 TV lines or more
- Vertical resolution	600 TV lines or more
(16) Power source	DC12V \pm 10% (100 mV (p-p) or less for ripple)
(17) Current consumption	Approx. 300 mA
(18) Ambient conditions	
- Performance guarantee	Temperature: 0 to 40°C, Humidity 20 to 80%RH (no condensation)
- Operating guarantee	Temperature: 0 to 45°C, Humidity 20 to 80%RH (no condensation)
- Storage	Temperature: -20 to 60°C, Humidity 20 to 95%RH (no condensation)
(19) Lens mount	C mount
(20) Dimensions	54(W) x 43(H) x 59(D)mm
(21) Weight	Approx. 150 g
(22) Applicable safety standards	EN50081-2/1993 EN61000-6-2/2001 FCC part15 class A

[Compliance with EMC standard]

The compliance of this device to the EMC standard is guaranteed in the condition with the optional parts in Section 4. If you use this product combined with parts other than specified by us, the customer should check the EMC compliance of the entire machine/device.

6. Interfaces

(1) CAMERA LINK connector (Base configuration)

- Connector MDR 26-Pin connector 10226-2210VE (3M)

- Pin assignment

Pin No.	I/O	Function	Pin No.	I/O	Function
1	-	GND	14	-	GND
2	Out	Tx OUT 0-	15	Out	Tx OUT 0+
3	Out	Tx OUT 1-	16	Out	Tx OUT 1+
4	Out	Tx OUT 2-	17	Out	Tx OUT 2+
5	Out	Tx CLK OUT-	18	Out	Tx CLK OUT+
6	Out	Tx CLK 3-	19	Out	Tx CLK 3+
7	In	Ser TC(RxD)+	20	In	Ser TC(RxD)-
8	Out	Ser TFG(TxD)-	21	Out	Ser TFG(TxD)+
9	In	CC1-	22	In	CC1+
10	In	CC2+	23	In	CC2-
11	In	CC3-	24	In	CC3+
12	In	CC4+	25	In	CC4-
13	-	GND	26	-	GND

- CAMERA LINK port assignment

Port	I/O	Function
Port A[7:0]	Out	ROUT[7:0] (R Image Output)
Port B[7:0]	Out	GOUT[7:0] (G Image Output)
Port C[7:0]	Out	BOUT[7:0] (B Image Output)
CC1	In	TRG (Trigger Input)
CC2	In	Reserved
CC3	In	Reserved
CC4	In	Reserved

(2) VIDEO OUT/DC IN connector

- Camera-side connector HR10A-10R-12PB (Hirose)

- Cable-side connector HR10A-10P-12S (Hirose)

- Pin assignment

Pin No.	I/O	Function
1	-	GND
2	In	+12V IN
3	-	GND
4	Out	VBS OUT
5	-	GND
6	Out	HD OUT
7	Out	VD OUT
8	-	N.C.
9	-	N.C.
10	Out	WEN OUT
11	In	TRG IN
12	-	GND

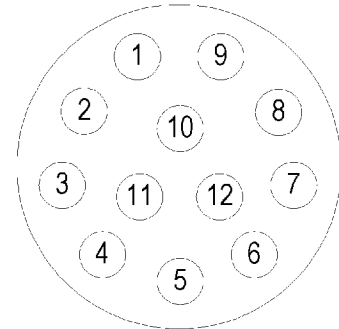

Seen from the back of the main body

7. Dip Switch Settings

You can set communication speed, memory call, and video output mode using the dip switches on the back of the main camera body.

Dip switch settings are loaded when the power is turned on. Changes will not be reflected if the switch settings are changed after the power is turned on.

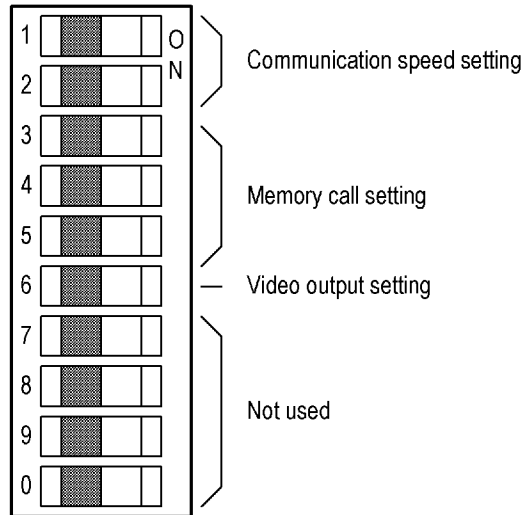

(1) Communication speed setting

You can set communication speed of the serial communication via CAMERA LINK. Either 9600 bps, 19200 bps, or 38400 bps can be set.

SW1	SW2	Communication speed
OFF	OFF	9600 bps
ON	OFF	19200 bps
OFF	ON	38400 bps

(2) Memory call setting

You can set setting value save memory numbers, which are called when the power is turned on. This camera has 8 memory tables in all.

SW3	SW4	SW5	Memory number
OFF	OFF	OFF	0
ON	OFF	OFF	1
OFF	ON	OFF	2
ON	ON	OFF	3
OFF	OFF	ON	4
ON	OFF	ON	5
OFF	ON	ON	6
ON	ON	ON	7

(3) Video output mode setting

You can set the video output mode (analog output/CAMERA LINK output) upon power on. If this is set to analog output, the camera starts up with the NTSC mode- AE, AWB operation. The switch setting specifies the initial operation upon power on. After the power is turned on, you can change the output mode during operation using command control via CAMERA LINK.

SW6	Video output mode
OFF	CAMERA LINK output
ON	Analog output

8. CAMERA LINK Serial Control

(1) Control Functions Overview

The following functions are available to control via CAMERA LINK serial communication interface (RS232C standard compatible).

- | | |
|--|---|
| - Output Method Selection | Analog (NTSC) / Digital (CAMERA LINK) |
| - Output Image Format Selection | SXGA 30fps / SXGA 15fps / VGA 30fps
* The setting is valid only under digital output mode. |
| - Shutter Mode Selection | Manual / Auto |
| - Auto Exposure Setting | Photometry Range Setting
AE Lock Setting
Exposure Correction Level Setting |
| - Random Trigger Shutter Operation Setting | Random Trigger: Valid / Invalid (Normal Shutter)
Trigger Polarity: Positive / Negative |
| - Shutter Speed Setting | |
| - Analog Pre-gain Setting | |
| - White Balance Operation Setting | FULL AUTO / One-push AUTO / MANUAL
Manual Color Temperature Setting
R,B Gain Setting |
| - Gamma Characteristics Selection | 0.45 / 0.65 / 1.0 / User Settings |
| - Edge Enhancement Setting | Edge Enhancement Level Setting |
| - Color Matrix Setting | |
| - Setting Value Memory | SAVE / LOAD /RESET |
| - Readout of Each Camera Data | |

(2) Command Communication Protocol

The command communication protocol is the teli standard method (method in which parameters are set in the registers in the camera).

In command send/receive operation, hexadecimal address and data are converted to ASCII data.

All ASCII alphabetic characters used are uppercase characters.

• Write to a register

To write data in a register, send a command, as follows:



For example, to write data 0x25 to address 0x75, send a command, as follows:



The camera responds to the write command with No Error (ACK) or Error (NAK), as follows:

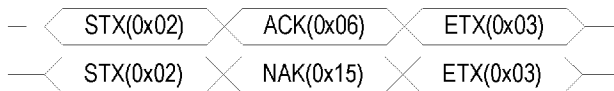

• Reading the register

To read data from a register, send "R" and "Q" following the address.

For example, to read data in address 0x6D, send a command, as follows:



The camera responds to the read request, as follows:



(3) Register Map

The registers accessible to the user are as follows:

	Address	Function	bit7	bit6	bit5	bit4	bit3	bit2	bit1	bit0	Default Value
Base Registers	0x00 0x03	Vendor Name (Read Only)	Vendor Name "TELI"								<<
	0x04 0x0F	Reserved	rsv.								0x00
	0x10 0x1F	Model Name (Read Only)	Model Name "CS6910CL"								<<
	0x20 0x2F	Serial Number (Read Only)	Serial Number								-
	0x30 0x3F	CPU Version (Read Only)	CPU Firmware Version ex)"V010000"								<<
Self Check Registers	0x40	Self-Check (Read Only)	Self-Check Result								-
	0x41	Status (Read Only)	Status Code								-
	0x42 0x4F	Reserved	rsv.								0x00
Memory Registers	0x50	Memory Information (Read Only)	Number Of Memory Banks In This Camera								0x08
	0x51	Memory Save	Save Bank No.								-
	0x52	Memory Load	Load Bank No.								-
	0x53	Memory Reset	Reset Bank No.								-
	0x54 0x5F	Reserved	rsv.								0x00
Base Function Registers	0x60	Update Registers Value (Write Only)	rsv.							1:EXEC	-
	0x61	Resolution Information (Read Only)	Maximum Resolution That This Camera Supports								0x07
	0x62	Frame Rate Information (Read Only)	Maximum Frame Rate at Maximum Resolution								0x04
	0x63	Resolution	0x04:VGA 0x07: SXGA 0x80:NTSC								0x07
	0x64	Frame Rate	0x03:15fps 0x04:30fps 0x06:60fps								0x04
	0x65	Shutter Type (Read Only)	rsv.							0:Global	0x00
	0x66	Shutter Mode	rsv.							0: Normal 1:RTS	0x00
	0x67	Trigger Polarity	rsv.							0:NEG 1:POS	0x00

CCD color camera CS6910CL Specification (Rev.B)

The contents described in this document may be changed without prior notice.

	Address	Function	bit7	bit6	bit5	bit4	bit3	bit2	bit1	bit0	Default Value
Base Function Registers	0x68	Random Trigger Shutter Mode	rsv.							0:Fix 1:Pulse	0x00
	0x69	Exposure Mode	rsv.							0: Normal 1:Auto	0x00
	0x6A	AE Area	rsv.							0: Center 1:Spot	0x00
	0x6B	AE Lock	rsv.							0:OFF 1:ON	0x00
	0x6C	Exposure Adjust	Exposure Adjust Value (0-9)								0x06
	0x6D	Denominator Of Exposure Time (Lower)	Denominator Of Exposure Time (0x0001-0x3A98)								0x1E
	0x6E	Denominator Of Exposure Time (Upper)									0x00
	0x6F	Numerator Of Exposure Time	rsv.			Numerator Of Exposure Time (0x01-0x08)				0x01	
	0x70	Gain (Lower)	Analog Pre-Gain (0x0000-0x00BF)								0x00
	0x71	Gain (Upper)									0x00
	0x72	Setup (Lower)	rsv.								0x00
	0x73	Setup (Upper)	rsv.								0x00
	0x74	WB Mode	rsv.							0:MWB 1:AWB 2:OPWB	0x00
	0x75	Manual Color Temperature	0x1E:3000[K] 0x25:3700[K] 0x28:4000[K] 0x2D:4500[K] 0x37:5500[K] 0x41:6500[K] 0xFF:Manual R and B Gain Available								0x37
	0x76	WB Auto Mode	rsv.								0x00
	0x77	One-Push WB (Write Only)	rsv.							1:EXEC	-
	0x78	Manual R Gain (Lower)	R Gain (0x0000-0x005F)								0x39
	0x79	Manual R Gain (Upper)									0x00
	0x7A	Manual B Gain (Lower)	B Gain (0x0000-0x005F)								0x2A
	0x7B	Manual B Gain (Upper)									0x00
0x7C	Aperture	rsv.				Aperture (0-7)				0x04	
0x7D	Gamma	rsv.							0: $\gamma=0.45$ 1: $\gamma=0.65$ 2: $\gamma=1.0$ 3: User Preset0	0x01	
0x7E 0xAF	Reserved	rsv.								0x00	

CCD color camera CS6910CL Specification (Rev.B)
The contents described in this document may be changed without prior notice.

	Address	Function	bit7	bit6	bit5	bit4	bit3	bit2	bit1	bit0	Default Value
Expansion Registers	0xB0	Target Address 0-7 Register	Indirect Access Target Address Register (bit0-7)								0x00
	0xB1	Target Address 8-15 Register	Indirect Access Target Address Register (bit8-15)								0x00
	0xB2	Target Address 16-23 Register	Indirect Access Target Address Register (bit16-23)								0x00
	0xB3	Target Address 24-31 Register	Indirect Access Target Address Register (bit24-31)								0x00
	0xB4	Target Address 32-39 Register	rsv.								0x00
	0xB5	Data Register	Indirect Access Data Register								-
	0xB6	Data Length Register	rsv.		Indirect Access Data Length						0x00
	0xB7	Sum Register	Indirect Access Sum Register								-
	0xB8	Expansion Status (Read Only)	Expansion Status Code								-
	0xB9 0xBF	Reserved	rsv.								0x00
	0xC0	CRB Coefficient	Color Matrix CRB Coefficient						0x4B		
	0xC1	CRR Coefficient	Color Matrix CRR Coefficient						0x64		
	0xC2	CBR Coefficient	Color Matrix CBR Coefficient						0x41		
	0xC3	CBB Coefficient	Color Matrix CBB Coefficient						0x5A		
	0xC4 0xCF	Reserved	rsv.								0x00

CCD color camera CS6910CL Specification (Rev.B)
The contents described in this document may be changed without prior notice.

(4) Access to Indirect Registers

To set the user-specified gamma table, use indirect access registers.

For indirect access, seven bytes of direct registers are used. These direct registers are as follows:

Target Address 0-7 Register	(Direct address: 0xB0)
Target Address 8-15 Register	(Direct address: 0xB1)
Target Address 16-23 Register	(Direct address: 0xB2)
Target Address 24-31 Register	(Direct address: 0xB3)
Target Address 32-39 Register	(Direct address: 0xB4 * This register is not used in this camera.)
Data Register	(Direct address: 0xB5)
Data Length Register	(Direct address: 0xB6)
Sum Register	(Direct address: 0xB7)

The function of each register is as follows.

- Target Address *-* Register
Indicates the address whose data is referred to or to which data is written.
- Data Register
During read operation, data stored in the Target Address *-* register is read.
During write operation, the specified data is written to the Target Address *-* Register.
When read or write operation is completed, the Target Address *-* Register is incremented.
- Data Length Register
Set the number of bytes to be read continuously. (Specified value +1) bytes of data are read continuously.
If 0 is specified, one byte of data is read.
- Sum Register
Every time a write or read command is executed for the Data Register, one-byte hexadecimal data read or written is added to the value of this register and the result is stored in this register.
When continuous write or continuous read is performed after 0x00 is written into this register, the camera side Check Sum of the data read or written data is stored after the continuous write or continuous read.

With the indirect access registers (Data Register: address 0xB5), continuous data write and continuous data read can be performed.

Up to 32 bytes of data can be written or read by continuous write or read.

- Continuous write

To perform continuous write, send a command as follows.

In continuous write, data of any length (up to 32 bytes) can be written.

The data length for continuous write has no relation to the setting value in the Data Length Register (address 0xB6).

The camera treats a reception of ETX, as the end of data.

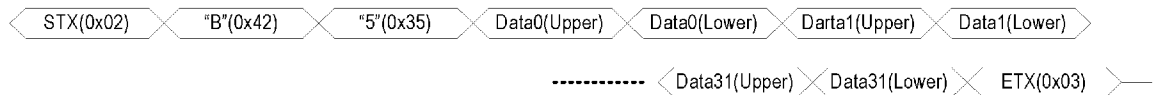

- Continuous read

In continuous read, the camera responds as follows.

If you request a read operation for the Data Register (address 0xB5), (the setting value of the Data Length Register (address 0xB6) + 1 byte) of data is read continuously.

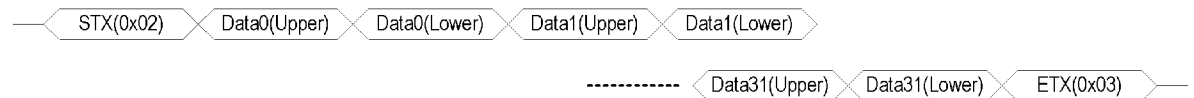

- Register map in the indirect address space

The register map in the direct address space is as follows.

Address	Function	bit7	bit6	bit5	bit4	bit3	bit2	bit1	bit0	Default Value
0x800000000	User Gamma 0	User Gamma 0								-
0x80000003FF										

9. Timing Charts

(1) SXGA output timing

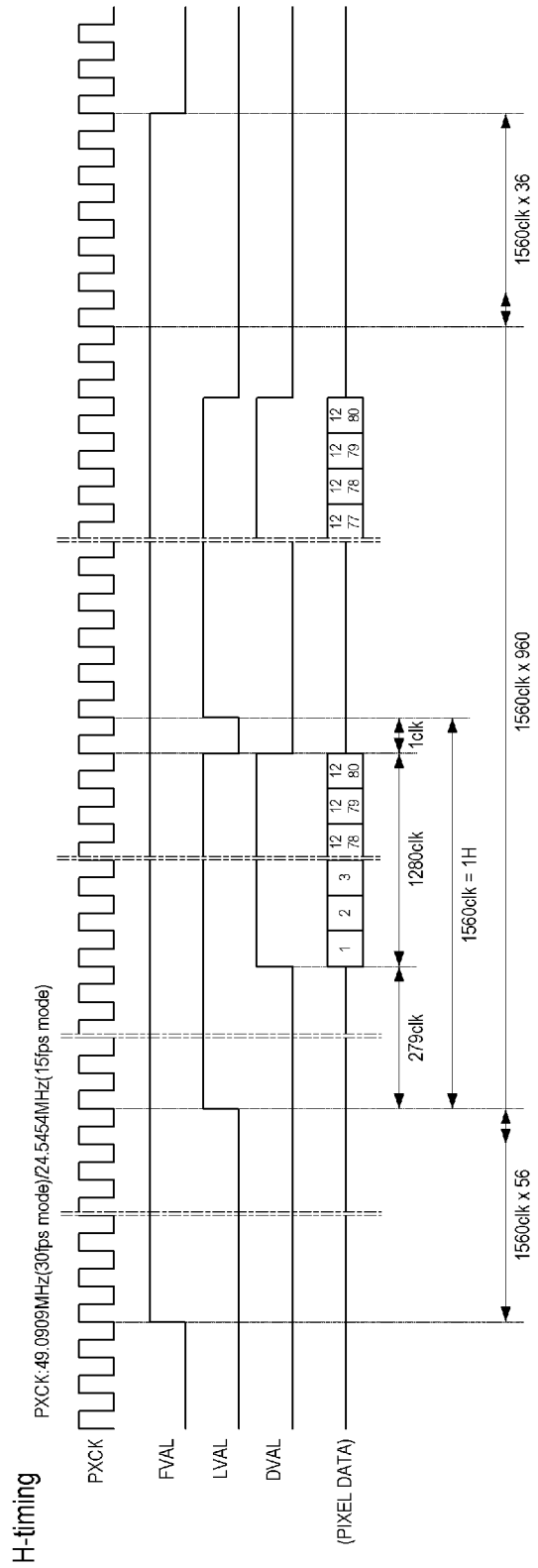
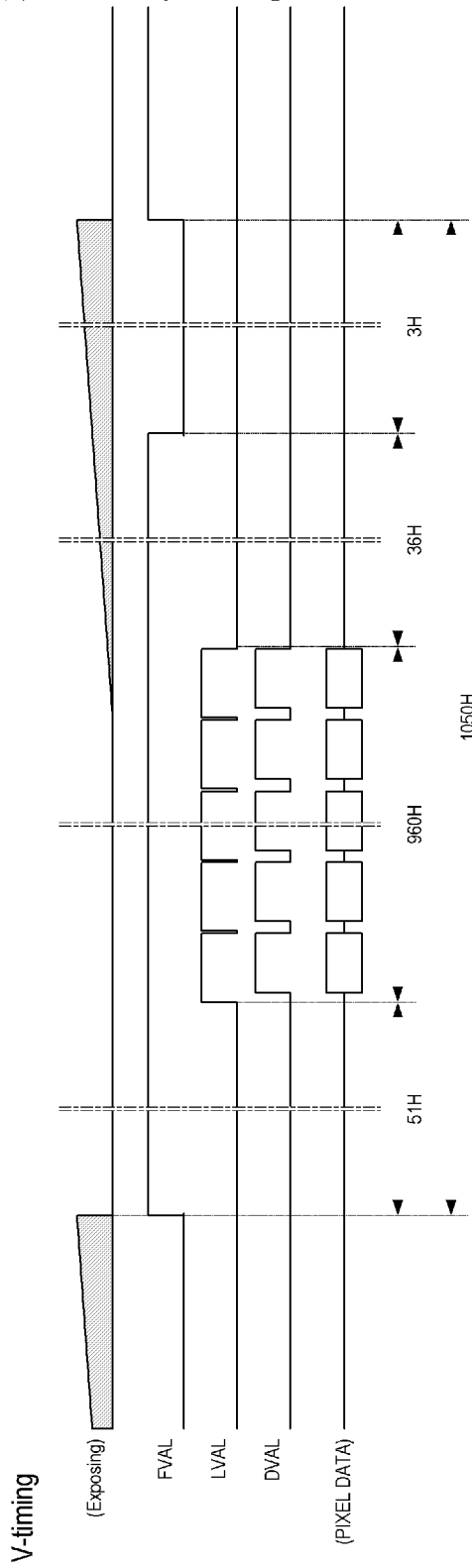

CCD color camera CS6910CL Specification (Rev.B)
The contents described in this document may be changed without prior notice.

(2) VGA output timing

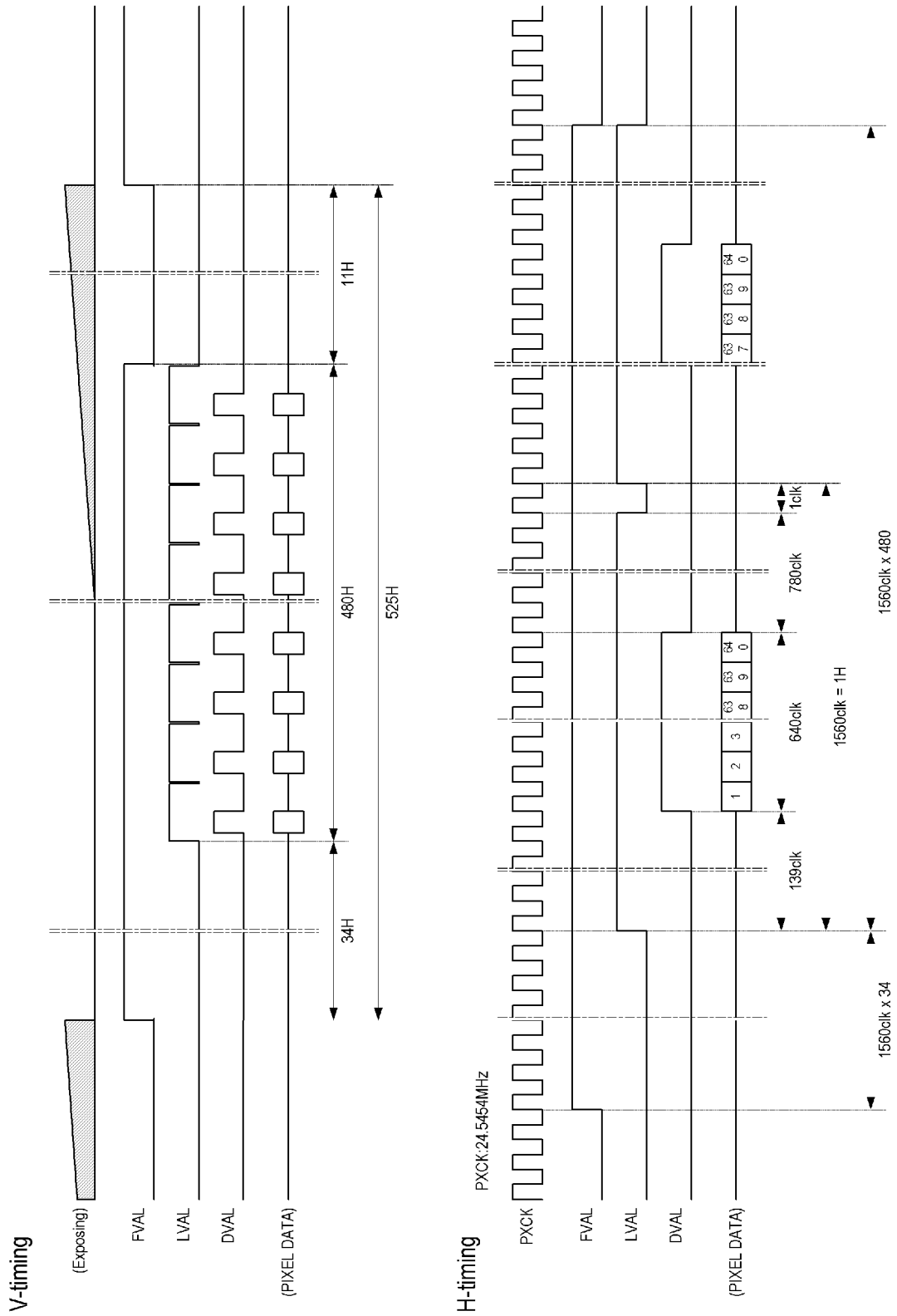

CCD color camera CS6910CL Specification (Rev.B)
 The contents described in this document may be changed without prior notice.

10. Outline Drawing

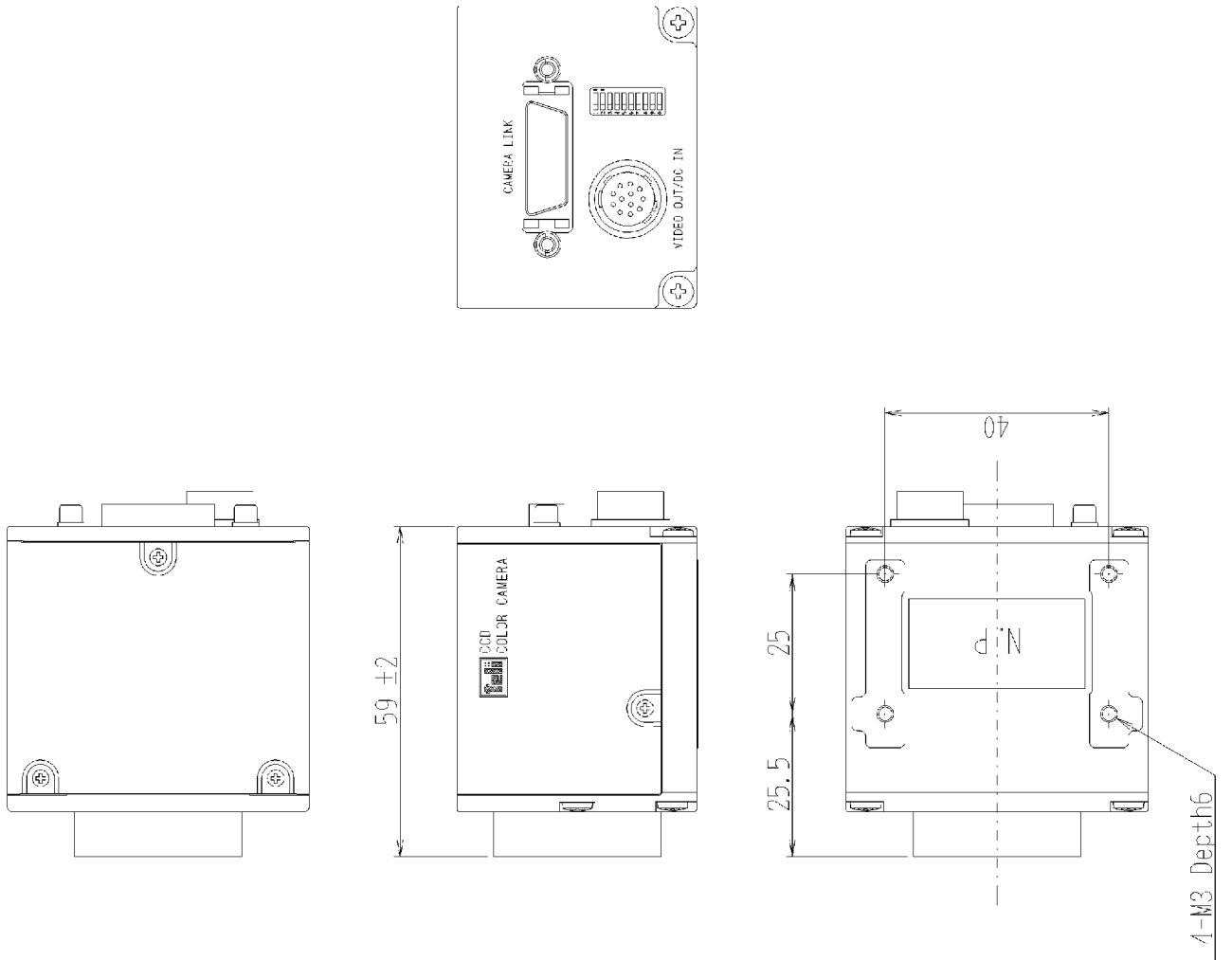

Specification

Mount, Chassis, Rear panel: Aluminum die-cast
 Cover : Anticorrosion aluminum alloy
 (leather satin coating)

Processing
 Mount, Chassis, Rear panel: Cation coating

CCD color camera CS6910CL Specification (Rev.B)
 The contents described in this document may be changed without prior notice.

11. Cases for Indemnity (Limited Warranty)

We shall be exempted from taking responsibility and held harmless for damage or losses incurred by the user in the following cases

- In case damage or losses are caused by fire, earthquake, or other acts of God, acts by a third party, deliberate or accidental misuse by the user, or use under extreme operating conditions.
- In case indirect, additional, consequential damages (loss of business interests, suspension of business activities) are incurred as result of malfunction or non-function of the equipment, we shall be exempted from responsibility for such damages.
- In case damage or losses are caused by failure to observe the information contained in the instructions in this instruction manual and specifications.
- In case damage or losses are caused by use contrary to the instructions in this instruction manual and specifications.
- In case damage or losses are caused by malfunction or other problems resulting from use of equipment or software that is not specified.
- In case damage or losses are caused by repair or modification conducted by the customer or any unauthorized third party (such as an unauthorized service representative).
- Expenses we bear on this product shall be limited to the individual price of the product.

12. Restriction for Use

- Should the equipment be used in the following conditions or environments, give consideration to safety measures and inform us of such usage:
 1. Use of the equipment in the conditions or environment contrary to those specified, or use outdoors.
 2. Use of the equipment in applications expected to cause potential hazard to people or property, which require special safety measures to be adopted.
- This product can be used under diverse operating conditions. Determination of applicability of equipment or devices concerned shall be determined after analysis or testing as necessary by the designer of such equipment or devices, or personnel related to the specifications. Such designer or personnel shall assure the performance and safety of the equipment or devices.
- This product is not designed or manufactured to be used for control of equipment directly concerned with human life (*1) or equipment relating to maintenance of public services/functions involving factors of safety (*2). Therefore, the product shall not be used for such applications.

(*1): Equipment directly concerned with human life refers to.

- Medical equipment such as life-support systems, equipment for operating theaters.
- Exhaust control equipment for exhaust gases such as toxic fumes or smoke.
- Equipment mandatory to be installed by various laws and regulations such as the Fire Act or Building Standard Law.
- Equipment related to the above.

(*2): Equipment relating to maintenance of public services/functions involving factors of safety refers to.

- Traffic control systems for air transportation, railways, roads, or marine transportation
- Equipment for nuclear power generation.
- Equipment related to the above.



TOSHIBA TELI CORPORATION

Head Office: 7-1, 4 chome, Asahigaoka, Hino-shi, Tokyo, 191-0065, Japan
(Overseas Sales Department)
Phone: +81-42-589-8771 Fax: +81-42-589-8774

URL: <http://www.toshiba-teli.co.jp>

Distributor

- This product must be classified for disposal according to the laws of each country and municipal laws.
- Information contained in this document is subject to change without prior notice.

CCD color camera CS6910CL Specification (Rev.B)
The contents described in this document may be changed without prior notice.