

A

記号 SYM	ゾーン ZONE	記 事 DESCRIPTION	年 月 日 DATE	変 更 者 REVD	承 認 APPD
-----------	-------------	--------------------	---------------	---------------	-------------

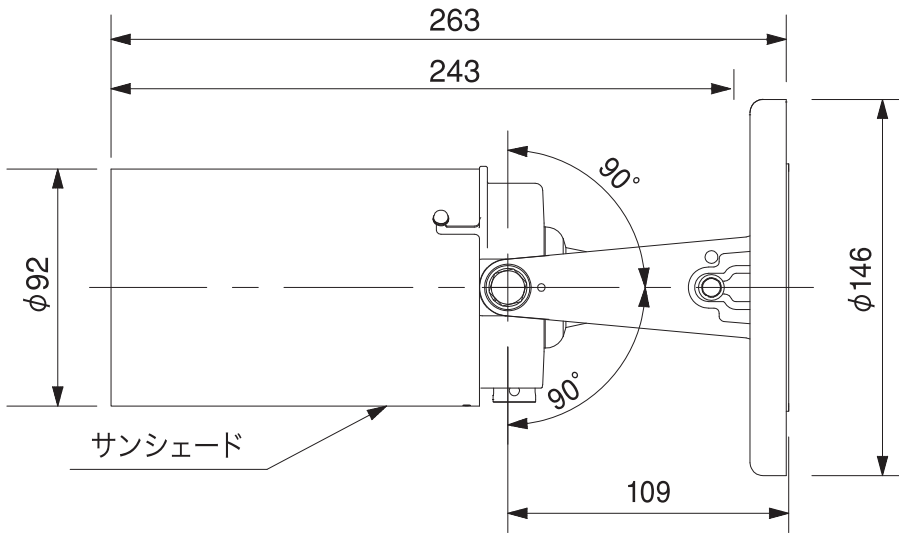
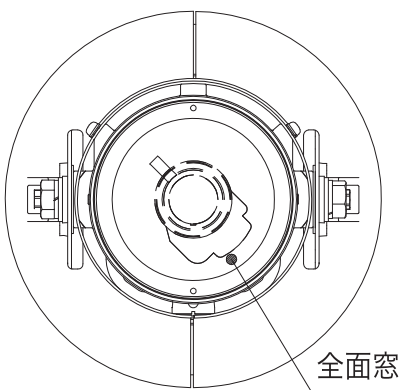

承認 APPROVED BY	第三角法 3RD ANGLE PROJECTION	公差 TOLERANCE	名称 TITLE VC8610	出 図
検 図 CHECKED BY	単 位 UNIT mm,g	尺 度 SCALE	形番号 MODEL NO.	関係図面 RELATION DWG NO.
設計 DESIGNED BY	東芝テリ株式会社 TOSHIBA TELI CORPORATION		図面番号 DRAWING NO.	変 更 REV. MARK
製 図 DRAWN BY			縮 図 REDUCE	

整理