

CMOS Color Camera BG Series

**BG205MC-CS
BG205MCF-CS**

Specifications

Toshiba Teli Corporation

Information contained in this document is subject to change without prior notice.

Standard name might be trade mark of each company.

Contents

RESTRICTION FOR USE	1
CASES FOR INDEMNITY (LIMITED WARRANTY)	2
USAGE PRECAUTIONS	3
1 Overview	5
2 Feature	5
3 Configuration	6
4 Optional part	6
5 Functions.....	7
6 Specifications	15
7 Timing chart	22
8 Warranty rules	26
9 Repair.....	27
10 Outline Drawing.....	28

RESTRICTION FOR USE

- Should the equipment be used in the following conditions or environments, give consideration to safety measures and inform us of such usage:
 - (1) Use of the equipment in the conditions or environment contrary to those specified, or use outdoors.
 - (2) Use of the equipment in applications expected to cause potential hazard to people or property, which require special safety measures to be adopted.
- This product can be used under diverse operating conditions. Determination of applicability of equipment or devices concerned shall be determined after analysis or testing as necessary by the designer of such equipment or devices, or personnel related to the specifications. Such designer or personnel shall assure the performance and safety of the equipment or devices.
- This product is not designed or manufactured to be used for control of equipment directly concerned with human life (*1) or equipment relating to maintenance of public services/functions involving factors of safety (*2). Therefore, the product shall not be used for such applications.
 - (*1): Equipment directly concerned with human life refers to.
 - Medical equipment such as life-support systems, equipment for operating theaters.
 - Exhaust control equipment for exhaust gases such as toxic fumes or smoke.
 - Equipment mandatory to be installed by various laws and regulations such as the Fire Act or Building Standard Law
 - Equipment related to the above
 - (*2): Equipment relating to maintenance of public services/functions involving factors of safety refers to.
 - Traffic control systems for air transportation, railways, roads, or marine transportation
 - Equipment for nuclear power generation
 - Equipment related to the above

CASES FOR INDEMNITY (LIMITED WARRANTY)

We shall be exempted from taking responsibility and held harmless for damage or losses incurred by the user in the following cases.

- Natural disasters, such as an earthquake and thunder, fire or any other act of God; acts by third parties; misuse by the user, whether intentional or accidental; use under extreme operating conditions.
- In the case of indirect, additional, consequential damages (loss of business interests, suspension of business activities) are incurred as result of malfunction or non-function of the equipment, we shall be exempted from responsibility for such damages.
- In the case damage or losses are caused by failure to observe the information contained in the instructions in this instruction manual and specifications.
- In the case damage or losses are caused by use contrary to the instructions in this instruction manual and specifications.
- In the case damage or losses are caused by malfunction or other problems resulting from use of equipment or software that is not specified.
- In the case damage or losses are caused by repair or modification conducted by the customer or any unauthorized third party (such as an unauthorized service representative).
- Expenses we bear on this product shall be limited to the individual price of the product.
- The item that is not described in specifications of this product is off the subject of the guarantee.
- The attachment mistake of a cable.

USAGE PRECAUTIONS

● Handle carefully

Do not drop the equipment or allow it to be subject to strong impact or vibration, as such action may cause malfunctions. Further, do not damage the connection cable, since this may cause wire breakage.

● Environmental operating conditions

Do not use the product in locations where the ambient temperature or humidity exceeds the specifications.

Otherwise, image quality may be degraded or internal components may be adversely affected. In particular, do not use the product in areas exposed to direct sunlight.

● Combination of CS-mount lens

Depending on the lens you use, the performance of the camera may not be brought out fully due to the deterioration in resolution and brightness in the peripheral area, occurrence of a ghost, aberration and others. When you check the combination between the lens and camera, be sure to use the lens you actually use.

When installing a lens in the camera, make sure carefully that it is not tilted.

In addition, use a mounting screw free from defects and dirt. Otherwise, the camera may be unable to be removed.

As for the CS-mount lens used combining this product, the projection distance from bottom of the screw should use 4.9mm or less.

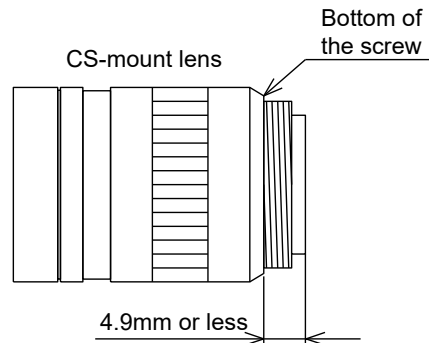

● Mounting to a pedestal

When mounting this product to a pedestal, make sure carefully that the lens doesn't touch with the pedestal.

● Do not expose the camera's image-pickup-plane to sunlight or other intense light directly.

Its inner CMOS sensor might be damaged.

● Occurrence of moiré

If you shoot thin stripe patterns, moiré patterns (interference fringes) may appear. This is not a malfunction.

● Occurrence of noise on the screen

If an intense magnetic or electromagnetic field is generated near the camera or connection cable, noise may be generated on the screen. If this occurs, move the camera or the cable.

USAGE PRECAUTIONS

- **Handling of the protective cap**

If the camera is not in use, attach the lens cap to the camera to protect the image pickup surface.

- **If the equipment is not to be used for a long duration**

Turn off power to the camera for safety.

- **Maintenance**

Turn off power to the equipment and wipe it with a dry cloth.

If it becomes severely contaminated, gently wipe the affected areas with a soft cloth dampened with diluted neutral detergent. Never use alcohol, benzene, thinner, or other chemicals because such chemicals may damage or discolor the paint and indications.

If the image pickup surface becomes dusty, contaminated, or scratched, consult your sales representative.

- **Disposal**

When disposing of the camera, it may be necessary to disassemble it into separate parts, in accordance with the laws and regulations of your country and/or municipality concerning environmental contamination.

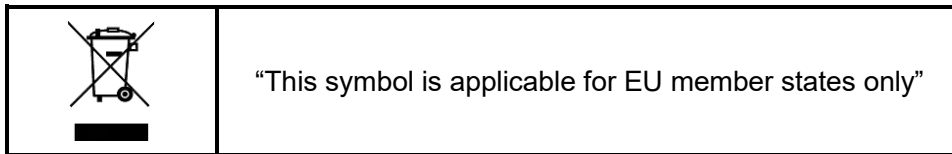

[Phenomena specific to CMOS sensor]

- **Defective pixels**

A CMOS image sensor is composed of photo sensor pixels in a square grid array. Due to the characteristics of CMOS image sensors, over- or under-driving of the pixels results in temporary white or black areas (as if these are noises) appearing on the screen. This phenomenon, which is not a defect is exacerbated under higher temperatures and long exposure time.

- **Image shading**

The brightness of the upper part of the screen may be different from that of the lower part.

Note that this is a characteristic of a CMOS image sensor and is not a fault.

1 Overview

This BG series is an integrated-(one-body)-type color camera that adopts a global shutter CMOS sensor. BG205MC-CS(2M 2/3 type, color) and BG205MCF-CS(2M 2/3 type, color, IR-cut). For video output and camera control, the Gigabit Ethernet®* interface standard "IEEE802.3ab" is adopted for high transfer rate, and it is easy to integrate into industrial equipment.

* Ethernet® is a registered trademark of XEROX Corporation.

2 Feature

2.1 High frame rate and high resolution

Supporting high frame rate, BG205MC(F)-CS 50fps.

2.2 Global shutter

As it employs a global electronic shutter similar to a CCD image sensor, clear images of even fast-moving object are obtainable with less blur.

2.3 Gigabit Ethernet interface (Power over Ethernet)

Video output and camera control are performed via the Gigabit Ethernet standard IEEE802.3ab interface. Data transfer is up to 1Gbps (Maximum) that enables to output uncompressed video data at high frame rate. By complying with IEEE802.3af Power over Ethernet (PoE), the power is supplied over single cable.

2.4 GigEVision Ver 1.2 conformity

This product is based on GigEVision Camera Interface Standard for Machine Vision Ver 1.2.

2.5 GenICam Ver 2.3 conformity

This product is based on GenICam Generic Interface for Cameras Ver 2.3.

2.6 Random Trigger Shutter

The Random Trigger Shutter function provides images in any timing by input of an external trigger signal. Trigger control from PC is available as well.

2.7 Scalable

Selectable video output area. This mode achieves higher frame rate by reducing vertical output area. And reduces occupied data rate of Gigabit Ethernet by reducing horizontal output area.

2.8 Decimation

Camera reads all effective areas at high speed by skipping lines.

2.9 Color processing

This BG series have built in color processing. Color processing features like white balance are available in Bayer output mode.

2.10 IR-cut filter

Build-in IR-cut filter models are optional for this BG series.

The character [F] of the model name indicates the built-in IR-cut filter model. (e.g. BG205MCF-CS)

* The character [F] is not shown in the common part of specifications.

2.11 Compact and lightweight

This camera is compact and lightweight; it is easy to integrate into industrial equipment.

2.12 EU RoHS & Chinese ROHS

3 Configuration

3.1 Camera body 1

* No application software and manuals are attached to this camera.

4 Optional part

- | | |
|-----------------------|------------------------------|
| - Camera mounting kit | Model name: CPT8600, CPTBUBG |
| - Camera Cable | CPCBG-xx |

* Contact your dealer / distributor for details of option units.

5 Functions

5.1 Gain

Manual gain and automatic gain control (AGC) are available. In AGC mode, camera gain is automatically adjusted to suit subject brightness.

Notes on gain setting:

Setting the gain value too high increases noises. When you adjust the brightness of the image, I ask you to have final image quality checked with your environment.

5.2 Black Level

Black level is adjustable from -5% to +25% as white saturation level is 100%.

5.3 Gamma

Gamma correction curve is adjustable from 0.45 to 1.00.

5.4 LUT (Look Up Table)

Arbitrary curve and binarization are possible by using 10 bit input and 10 bit output LUT.

5.5 Packet Resend

GigEVision Packet Resend feature is supported.

5.6 Exposure Time

Automatic exposure time control (AE) and manual exposure time (MANUAL) are available.

5.6.1 AE

The exposure time is adjusted automatically to suit subject brightness.

This mode can also operate with AGC (Automatic Gain Control) to automatically adjust fluctuations in subject brightness across a wide range (ALC operation).

5.6.2 MANUAL

Exposure time is adjustable by micro-second unit.

5.7 White balance

This BG series have two white balance modes, manual white balance (MWB) and one-push auto white balance (OPWB). Select the mode to suit the subject and purpose.

5.7.1 MWB

R/B gain can be set independently.

5.7.2 OPWB

When OPWB is executed, the camera adjusts R/B gain automatically.

5.8 Black Level Correction

The changing of the black level by using image sensor characteristics is reduced.

5.9 Random Trigger Shutter

An image is captured at the desired timing using trigger signal input. External trigger signal from trigger input connector and software trigger from control command are available. Trigger polarity is selectable (High active / Low active).

Note that Random Trigger Shutter will cause a delay between trigger signal and start of exposure. See 7. Timing Chart for detail.

- Timed mode

The exposure time is determined by Exposure Time setting.

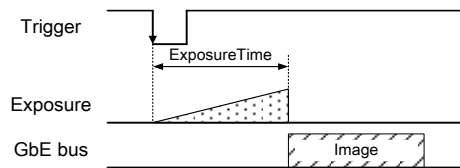

- TriggerWidth mode

The exposure time is determined by the pulse width of the trigger signal.

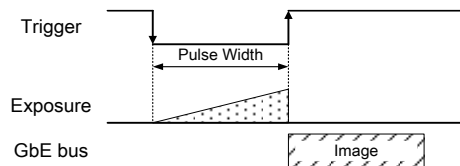

- FrameBurst(Bulk) mode

Camera exposes and transfers multiple frames by a single trigger.

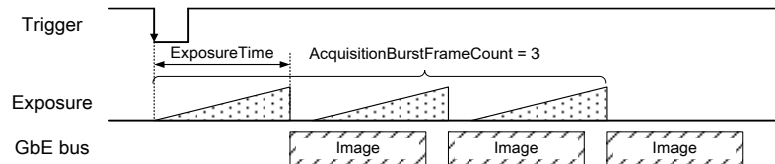

Notes on Random Trigger Shutter mode:

- In the period when FRAME_TRIGGER_WAIT signal is inactive, user must not input external trigger signal to this camera.
- When the interval of the input trigger signal is extremely short, or when the trigger signal is noisy, there is a possibility of causing the malfunction. In this case, please input a proper trigger signal.

5.10 Trigger Delay

You can add the delay between trigger signal input and the start of exposure.

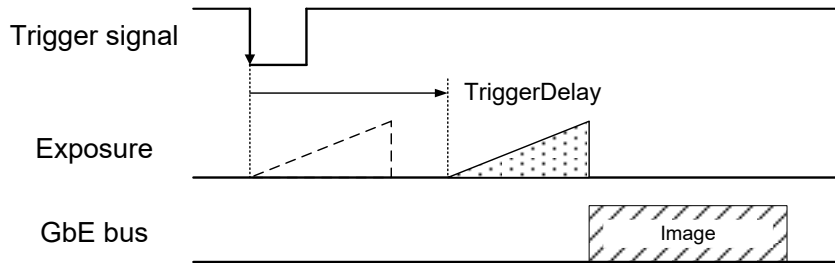

5.11 Anti-Chattering

Anti-Chattering control filters noise and unstable logic value of the trigger input signal.

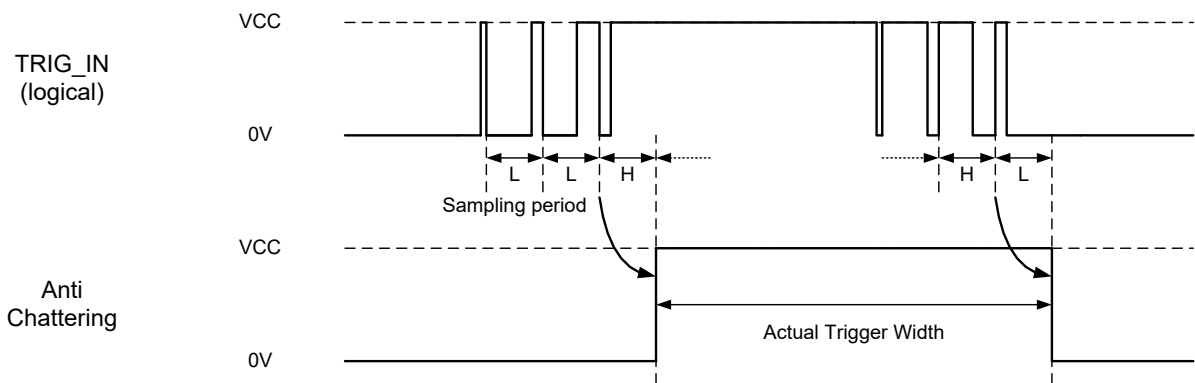

5.12 Event

Camera notifies of FrameTrigger status and ALC information by GigEVision Event Packet.

- FrameTrigger : Reception of Frame Start Trigger
- FrameTriggerError : Rejection of Frame Start Trigger
- FrameTriggerWait : Start of waiting for Frame Start Trigger
- ALCLatestInformation : ALC Information is updated
- ALCConverged : ALC is converged

FrameTrigger events timing are as following chart.

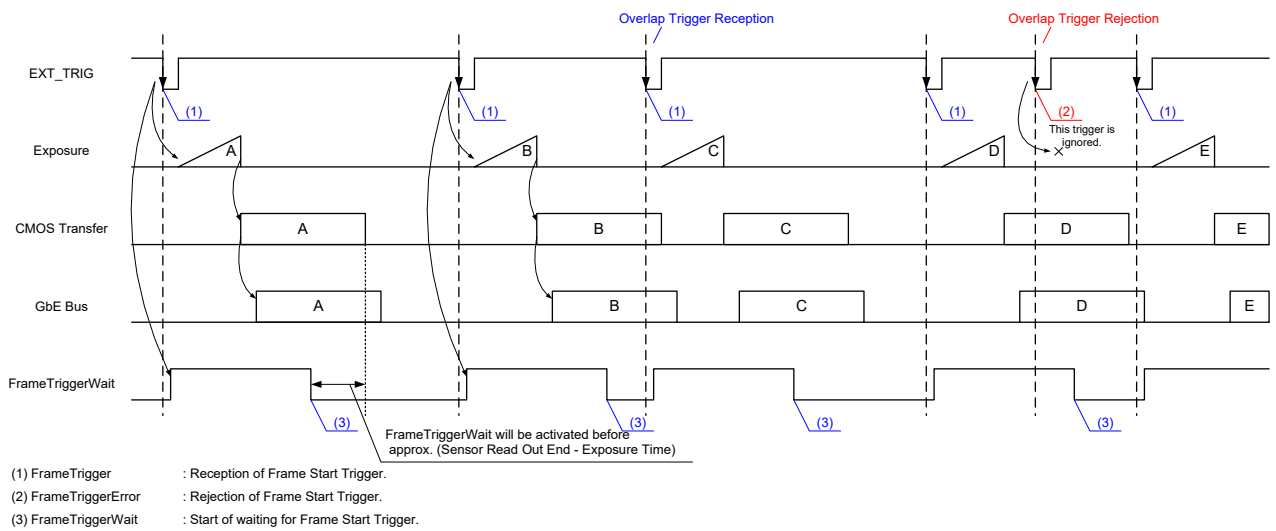

5.13 GPIO

Selected signals are output from GPIO pins of I/O connector. Following signals are selectable.

- VD : Internal VD sync signal.
- TIMER0 ACTIVE : This signal can be used as strobe control signal. The delay time and pulse width of this signal are configurable.
- EXPOSURE ACTIVE : Period from exposure start to end.
- FRAME ACTIVE : Period from exposure start to CMOS transfer completion.
- FRAME TRANSFER : Period of Ethernet packet transfer.
- FRAME TRIGGER WAIT : Indicating waiting a Random Trigger Shutter. An External trigger is input during this period, exposure starts immediately.

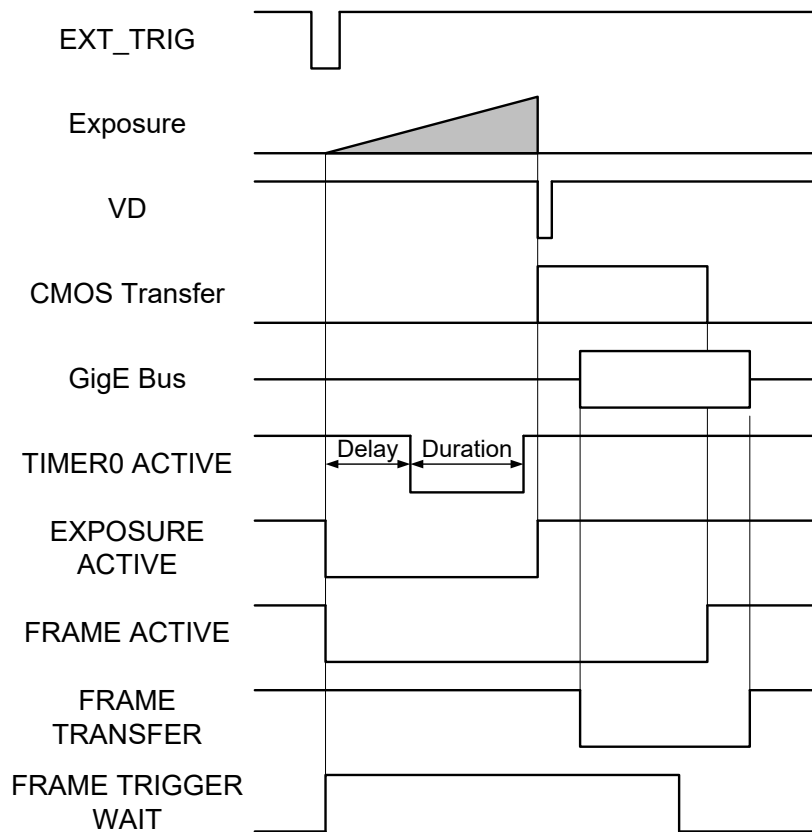

* GPIO:default=Active Low

5.14 Scalable mode

Scalable mode is to read out arbitrary area of the image. Only single rectangle is selectable. Concave or convex shape is not selectable.

- Window size: $\{A + 4 \cdot m \text{ (H)}\} \cdot \{B + 2 \cdot n \text{ (V)}\}$

A, B = minimum unit size

m, n = integer

The window size is equal or less than maximum image size.

- Start address: $\{4 \cdot i \text{ (H)}\} \times \{2 \cdot j \text{ (V)}\}$

i, j = integer

The window size is equal or less than maximum image size.

	BG205MC-CS
Width and OffsetX unit size	4
Height and OffsetY unit size	2
Minimum unit size (H) * (V)	64 x 64
Maximum unit size (H) * (V)	2048 x 1088

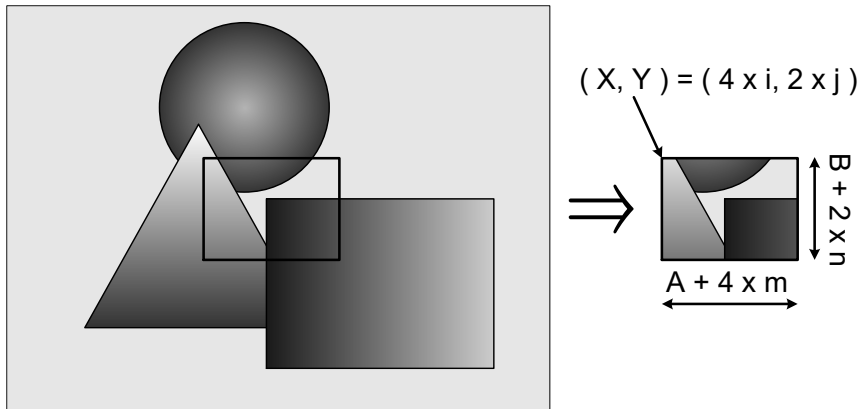

In the scalable mode, camera reads out only necessary area at the normal speed and reads out other area at high speed. The trigger interval can be shorter when the vertical height size is small.

5.15 Decimation

Camera reads all effective areas at high speed by skipping lines.

Model Name	BG205MC-CS
Decimation	1,2,4,8 line

5.16 Reverse

Image can be flipped in horizontal and/or vertical direction.

5.17 FPN Correction

It is possible to suppress FPN (Fixed Pattern Noise) of image.

5.18 User Free Memory

A free memory area is available to read and write arbitrary data for user. Individual numbers can be assigned when multiple BG cameras are connected.

5.19 Test Pattern

Following test patterns are available

- Black : Full screen 0 LSB (@ 8-bit)
- White : All pixels 255 LSB (@ 8-bit)
- Bright Gray : Full screen 85 LSB (01010101B) (@ 8-bit)
- Dark Gray : Full screen 170 LSB (10101010B) (@ 8-bit)
- Ramp waveform

6 Specifications

6.1 Electrical specification

Model Name	BG205MC-CS	BG205MCF-CS
IR-cut filter	None	Built-in
Imager	CMOS image sensor	
Number of active pixels (H) x (V)	2048 x 1088	
Scanning area (H) x (V) [mm]	11.26 x 5.98 (2/3 type)	
Pixel size (H) x (V) [μm]	5.5 x 5.5	
Scan method	Progressive	
Electronic shutter method	Global shutter	
Aspect ratio	2:1	
Sensitivity	2300lx (F11, 1/50s)	2900lx (F11, 1/50s)
Minimum illuminance	3lx	4lx
	F1.4, Gain +18dB, Video level 50%	
Gain (Digital gain)	MANUAL, AGC (factory setting: MANUAL)	
Setting range	0dB to +18dB (factory setting : 0dB)	
AGC effective area	Full (Full pixel) / Medium (Central: 80% x 80%) / Small (Central: 20% x 20%)	
Black Level	-5 to 25% (factory setting : 0% [0LSB@8bit])	
Gamma	$\gamma=1.0$ to 0.45 (factory setting : $\gamma=1.0$)	
White balance	MWB, OPWB (factory setting : MWB)	
Effective range	3,500~6,500K	2,500~6,500K
MWB setting format	R/B gain independent setting: x0.5 to x8 (factory setting : x1)	
OPWB effective area	Same as AGC effective area setting	
LUT	Input 10 bit, Output 10 bit	
User Setting Memory	3 channels	
User Free Memory	16 Byte	
Test Pattern	Black, White, Bright Gray, Dark Gray, Ramp waveform (factory setting: OFF)	
Power supply	PoE (Power over Ethernet IEEE802.3af compliant) or DC+12V $\pm 10\%$ (ripple 100 mV(p-p) or less)	
Power consumption(*1)	PoE	2.9W Max
	DC12V	2.5W Max

(*1) at all pixels readout

6.2 Electronic shutter specification

Exposure time	MANUAL, AE (factory setting: MANUAL)
MANUAL	10 μ s to 1s
AE effective range	Same as MANUAL setting
AE effective area	Same as AGC effective area setting
AE Exposure value	$\pm 2EV$

6.3 Random Trigger Shutter specification

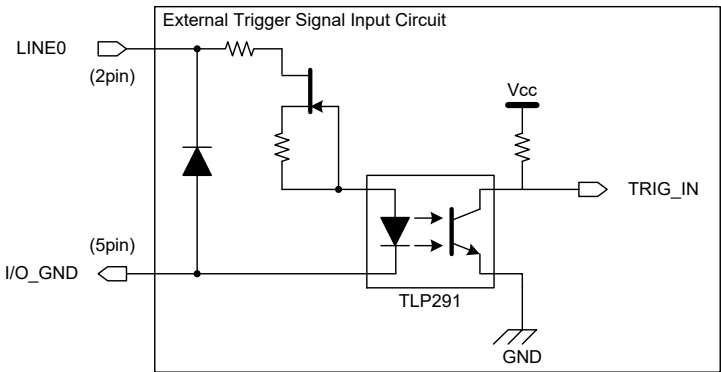
Trigger Mode	External trigger, Software trigger (factory setting: External trigger)
External trigger	Input via I/O connector (Line0)
Input level	Low: 0 to 0.5V, High: 3.3 to 24.0V
Input Current	5 to 15mA
Polarity	High active / Low active (factory setting: Low active)
Pulse width	200 μ s (minimum)
Input circuit	<p style="text-align: center;">Photo coupler input</p>  <p>* Depending on cable length, cable kinds and input current of trigger input line, Random Trigger Shutter operation may not satisfy timing specification or camera may not receive EXT_TRIG signal.</p>
Software trigger	GigE Vision Command (GVCP) control
Exposure time	Timed mode, TriggerWidth mode (factory setting: Timed)
Timed mode	The exposure time depends on the MANUAL Exposure time setting
TriggerWidth mode	The exposure time depends on External trigger width
FrameBurst mode	The exposure time depends on the MANUAL Exposure time setting
Number of Exposures	Max 255 times
Trigger Delay	0 to 4095 μ s (factory setting: 0 μ s)
Anti-Chattering sampling period	2 to 1,000 μ s (factory setting: 2 μ s)

6.4 GPIO Output signal specification

Output channel	2 channels	
Output line name	Line1	Line2
Output signal	VD, TIMER0 ACTIVE, EXPOSURE ACTIVE, FRAME ACTIVE, FRAME TRANSFER, FRAME TRIGGER WAIT	
Output level	LVTTL	Open Collector
Maximum Current	+/-24mA (drive current)	50mA (input current)
Output circuit	<p>The diagram illustrates the GPIO Signal Output Circuit. It is divided into two channels. Channel 1 (Line1) consists of a 3-pin connector connected to GND (6-pin) and GPIO0. Channel 2 (Line2) consists of a 4-pin connector connected to I/O_GND (5-pin) and GPIO1. The circuit includes a TLP291 optocoupler, a Vcc supply, and a pull-up resistor.</p>	
Polarity	High active / Low active (factory setting: Low active)	
TIMER0 ACTIVE		
Delay	0 to 2000000μs (factory setting: 0s)	
Duration	0 to 2000000μs (factory setting: 0s)	

6.5 Interface specification

Interface	Gigabit Ethernet IEEE802.3ab (1000BASE-T) conformity
Transmission speed	1Gbps (Maximum)
Protocol	GigEVision Camera Interface Standard for Machine Vision Ver 1.2
Conformity cable	Twist pair (Category 5e or over)
Cable length	Up to 100m (at the Unshielded Twist Pair (UTP) cable)

6.6 Image output format

Model	BG205MC-CS
Image output format	GVSP_PIX_BAYGR8: BayerGR8 8bit (ReverseX = False / ReverseY = False)
	GVSP_PIX_BAYRG8: BayerRG8 8bit (ReverseX = True / ReverseY = False)
	GVSP_PIX_BAYBG8: BayerBG8 8bit (ReverseX = False / ReverseY = True)
	GVSP_PIX_BAYGB8: BayerGB8 8bit (ReverseX = True / ReverseY = True)
Maximum Frame rate (at all pixels readout)	50 fps

Notes on Dropping Frames:

Depends on your PC or Gigabit Ethernet interface board configurations, images may not be captured properly (e.g. dropping frames). In this case, change to frame rate setting lower.

6.7 Event notification

Event name	FrameTrigger, FrameTriggerError, FrameTriggerWait ALCLatestInformation, ALCCConverged
Event notification delay	approx. 4ms later from the event occurs
Time stamp unit	16ns (62.5MHz)

6.8 Machine external specification

	BG205MC-CS	BG205MCF-CS
Dimensions	29 mm(W) x 29 mm (H) x 40 mm (D) (Not including protrusion)	
Mass	Approximately 50g	Approximately 51g
Lens mount	CS-mount	
Flange back	12.5 mm	
Camera body grounding insulation status	Non-conductive between circuit GND and camera body	

6.9 Operation Ambient conditions

Operation assurance	Temperature: 0°C to +40 °C, Camera housing temperature: less than 50 °C Humidity: 10% to 90% (no condensation)
Storage assurance	Temperature: -20°C to +60 °C Humidity: 90% or less (no condensation)
EMC condition	EMI (Electro-Magnetic interference) : EN61000-6-4 FCC Part 15 Subpart B Class A EMS (Electro-Magnetic susceptibility) : EN61000-6-2

Notes on Heat Radiation:

The top surface temperature of camera housing must be kept less than 50°C in principle. However, about the upper limit of top surface temperature of camera housing and the allowed ambient temperature of each model, please refer to the "Thermal design manual" on our website.

Notes on Conformity of the EMC:

The adaptability of the safety standard of this camera is assured in the condition of combination with the following parts:

<<PoE operation>>

- PoE Switch GS108P-100AJS (NETGEAR Inc.)
- LAN Cable LD-TWST/BM30 (ELECOM CO., LTD)

<<DC operation>>

- DC Cable CPCBG-03
- LAN Cable LD-TWST/BM30 (ELECOM CO., LTD)

Please confirm the EMC adaptability when it combines with parts other than them.

6.10 Connector pin assignment

Gigabit Ethernet interface connector			
RJ-45 Jack			
Pin No.	I/O	Signal Name	Function
1	I/O	BI_DA+ / VDC+	Bidirectional Data A (+) / Power (+)
2	I/O	BI_DA- / VDC+	Bidirectional Data A (-) / Power (+)
3	I/O	BI_DB+ / VDC-	Bidirectional Data B (+) / Power (-)
4	I/O	BI_DC+ / VDC+	Bidirectional Data C (+) / Power (+)
5	I/O	BI_DC- / VDC+	Bidirectional Data C (-) / Power (+)
6	I/O	BI_DB- / VDC-	Bidirectional Data B (-) / Power (-)
7	I/O	BI_DD+ / VDC-	Bidirectional Data D (+) / Power (-)
8	I/O	BI_DD- / VDC-	Bidirectional Data D (-) / Power (-)

I/O Connector

Connector (Camera side)

HR10A-7R-6PB(73) (Hirose) or equivalent

Plug (Cable side)

HR10A-7P-6S(73) (Hirose) or equivalent

Camera cable is not an accessory of this product.

Connector view from mating face

Camera side

Cable side

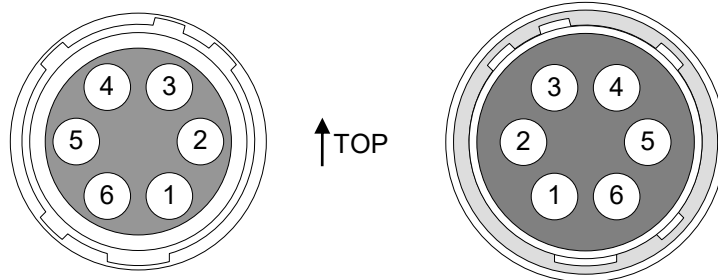

Pin No.	I/O	Signal Name	Function
1	I	+12V	Power
2	I	Line 0	External Trigger Input
3	O	Line 1	GPIO_0 Output
4	O	Line 2	GPIO_1 Output
5	-	I/O GND	GPIO_Ground
6	-	GND	Ground

Notes on Power Supply:

This camera has two ways of power supply,

- Supply from LAN cable (PoE)
- Supply from camera cable (DC+12V \pm 10%)

If both PoE and DC+12V are connected, power is supplied from PoE.

6.11 Typical spectral response

The lens characteristics and light source characteristics is not reflected in table.

<BG205MC-CS >

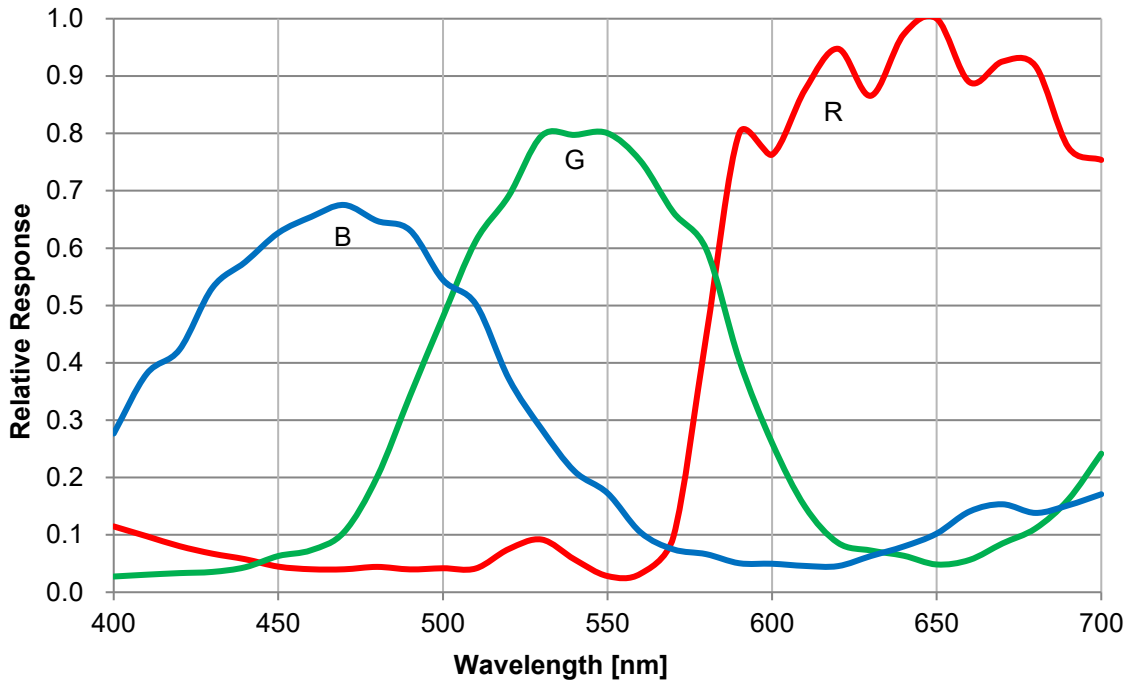

<BG205MCF-CS >

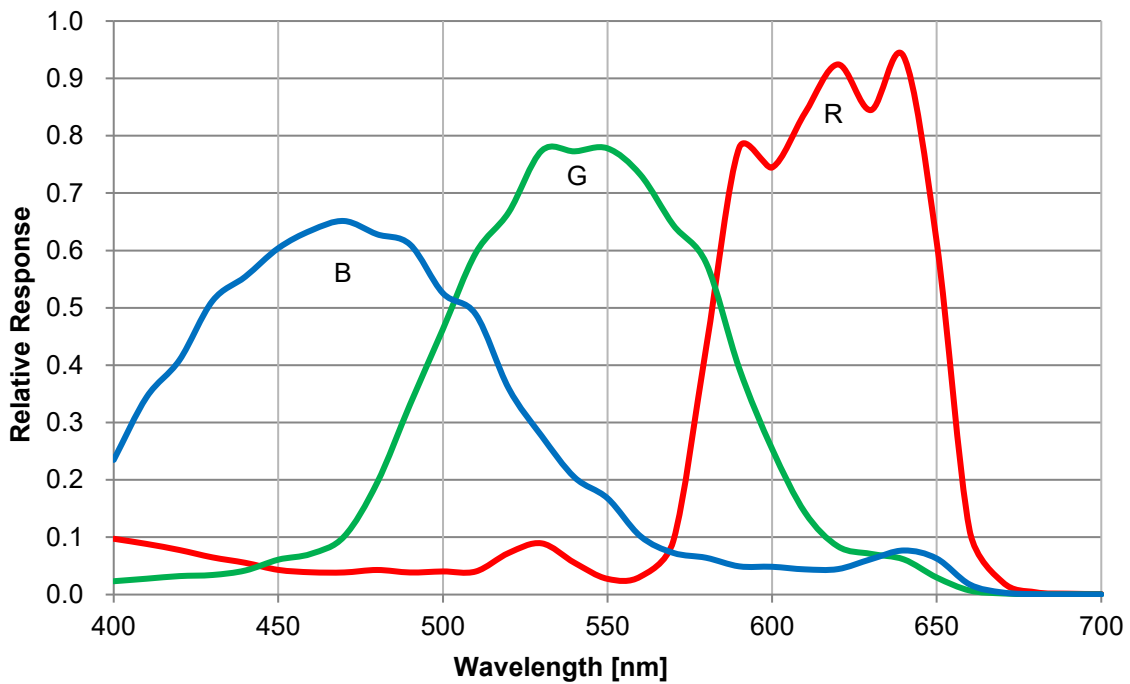

7 Timing chart

Image data outputs are transferred with the UDP protocol of Gigabit Ethernet. Timing numerical value below is described by absolute prerequisite that camera can use transmission band without restriction of other node. When there is other node using the same network, the value described below is not guaranteed.

7.1 GbE bus transfer timing (at all pixels readout)

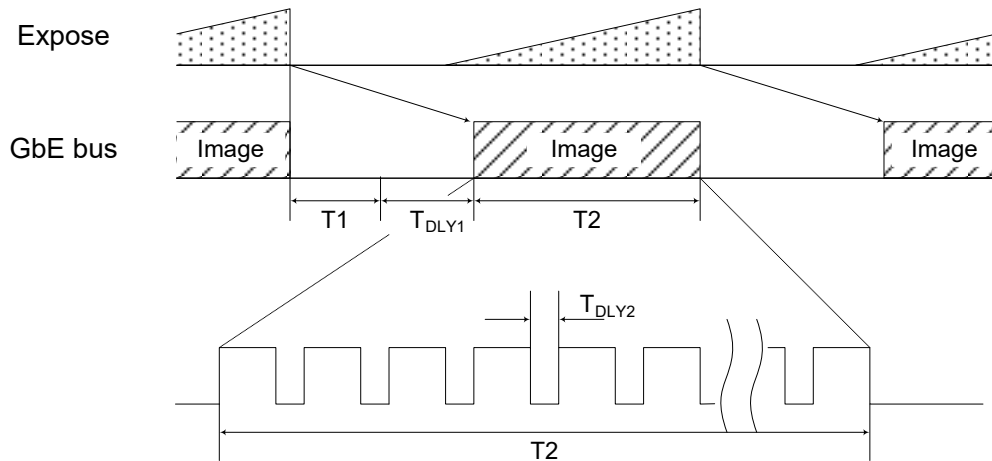

Model Name	T1 [ms]	T2 [ms]	Default Frame Rate [ms]
BG205MC-CS	see following formula.	same as Frame Rate.	20.0

* TDLY1 : GVSP_BLOCK_START_DELAY

* TDLY2 : SCPD (Stream Channel Packet Delay)

$$* T1 = (T2 / (\frac{\text{PayloadSize}}{\text{SCPS} - 36})) \times 3, T1 = 100\mu\text{s or longer.}$$

PayloadSize is total bytes of single frame.

The formula applies when SCPS (Stream Channel Packet Size) is 1500 byte / packet.

(T1 varies depending on the value of SCPS)

7.2 Random Trigger Shutter timing

7.2.1 External trigger signal input

The specifications of external trigger input signal are as follows;

- Trigger amplitude : +3.3 to +24V
- Pulse width : Minimum 200μs

The received external trigger signal delays as follows.

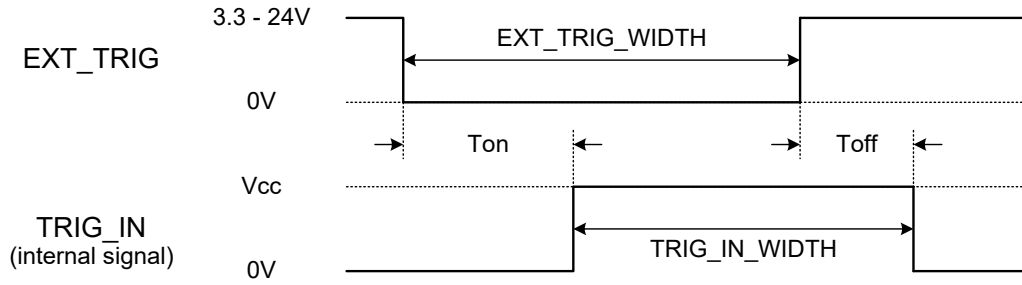

(a) Negative trigger

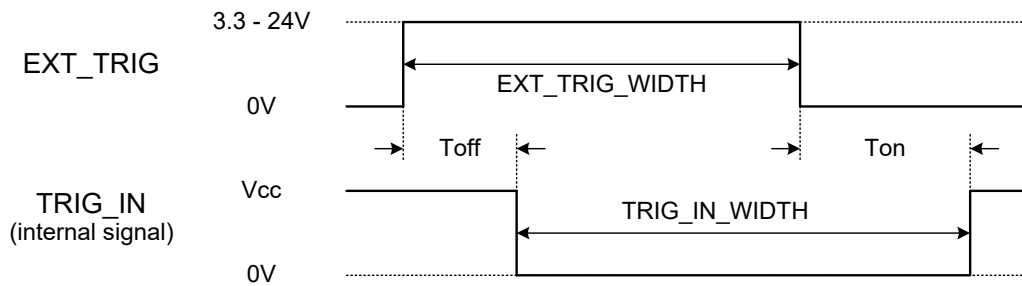

(b) Positive trigger

EXT_TRIG_WIDTH: The pulse width of the external trigger input (more than 200μs).

Toff: The delay time of falling edge.

Ton: The delay time of rising edge.

TRIG_IN_WIDTH: The pulse width of the trigger signal which is received inside of the camera.

- Negative trigger: $TRIG_IN_WIDTH = EXT_TRIG_WIDTH - (T_{on} - T_{off})$

- Positive trigger: $TRIG_IN_WIDTH = EXT_TRIG_WIDTH + (T_{on} - T_{off})$

Trigger amplitude	Toff [μs]	Ton [μs]
+3.3V	2.92	26.2
+12V	2.12	31.2
+24V	2.12	31.2

* Toff and Ton are typical value.

* These values vary depending on operating environment.

7.2.2 Timed mode / FrameBurst mode (at all pixels readout)

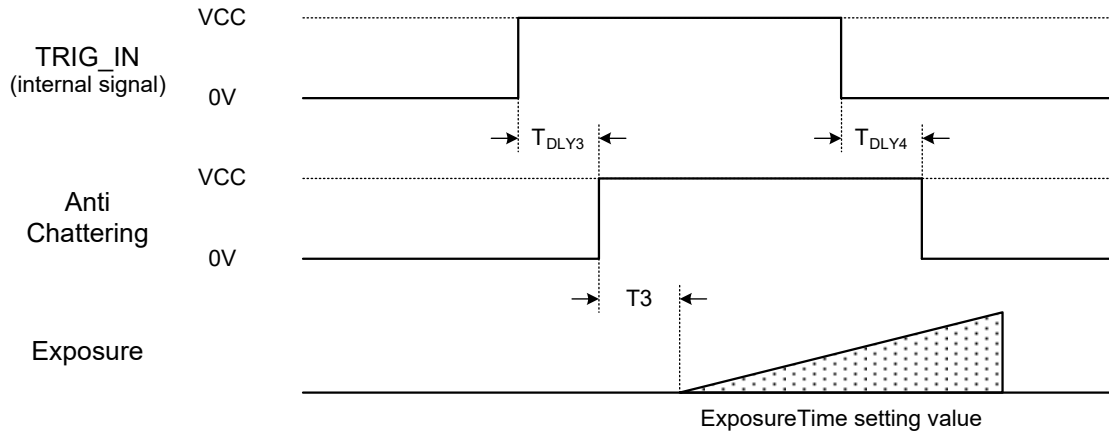

7.2.3 TriggerWidth mode (at all pixels readout)

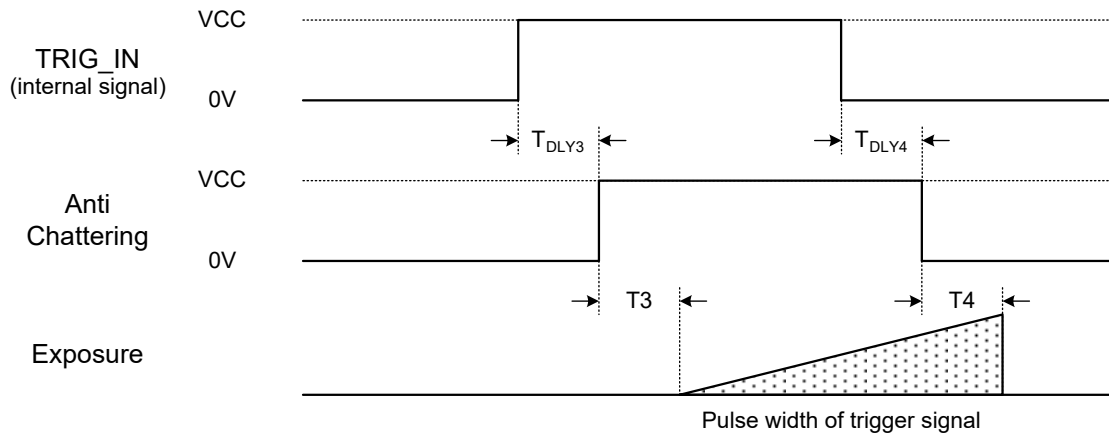

Model Name	T3 [μ s]	T4 [μ s]
BG205MC-CS	0.26	0.26

* TDLY3, TDLY4: TriggerSamplingPeriod (typical value)

Max TriggerSamplingPeriod x 1.625[μ s], Min TriggerSamplingPeriod x 0.625[μ s]

* T3 and T4 are typical value.

Notes on Random Trigger Shutter mode:

- In the period when FRAME_TRIGGER_WAIT signal is inactive, user must not input external trigger signal to this camera.
- When the interval of the input trigger signal is extremely short, or when the trigger signal is noisy, there is a possibility of causing the malfunction. In this case, please input a proper trigger signal.

7.2.4 GPIO signal output

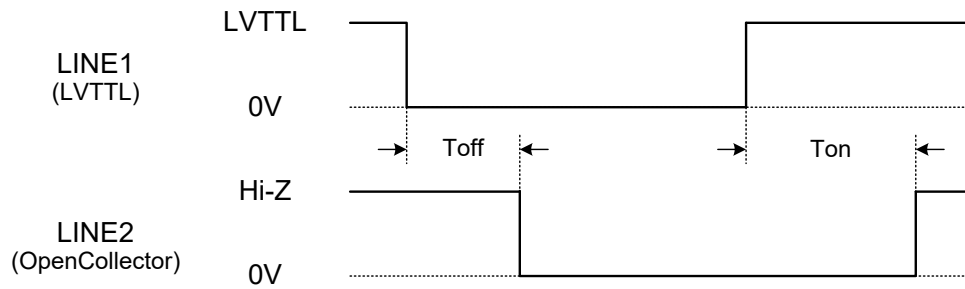

(a) ActiveLow

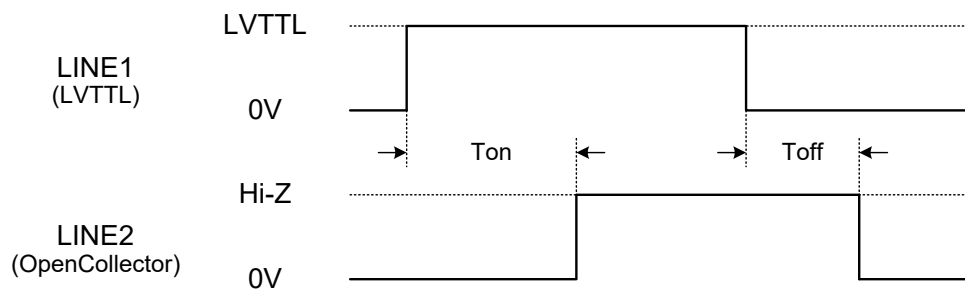

(b) ActiveHigh

Toff: LINE1~LINE2 falling delay time

Ton: LINE1~LINE2 rising delay time

LINE2 amplitude	Toff [μ s]	Ton [μ s]
+3.3V	3	53.2
+12V	4	78.4
+24V	5	94.4

* Toff and Ton are typical value.

* These values vary depending on operating environment.

8 Warranty rules

8.1 Warranty term

Warranty term is 36 months after your purchase. We may assume the date of the purchase from our shipping date when the date is unidentified.

8.2 Limited Warranty

Free warranty is not applicable for the troubles, damages or losses caused by the cases of the followings, even if it is during the warranty term.

1. Natural exhaust, wear or degradation of a component parts
2. Handling against the instructions and conditions described in the instruction manual
3. Remodeling, adjustment and the part exchange. (including the opening of the enclosure box and the alteration)
4. Using the accessories not included with the product or our non-designated optional articles
5. Damages caused during the transportation or deficiency of the handling such as drop or fall of the products after the products having been transferred to customers, leaving the products to corrosive environment such as sunlight, fire, sand, soil, heat, moisture, or an inappropriate storing method
6. A fire, an earthquake, a flood, a lightning, or other natural disasters, pollution and a short circuit, abnormal voltage, excessive physical pressure, theft, other accident
7. When connected to a product which is not recommended
8. When connected to the power supply which is not suitable
9. Forgery product, products which does not have proper serial number, products of which serial number is forged, damaged or deleted
10. All defects that happened after the expiration for a warranty term

9 Repair

9.1 Repair Methods

Exchange to a replacement or an equal function product.

9.2 Repair request methods

On the occasion of a repair request, please download the "Failure situation report sheet" from our website, fill in the necessary items and return it together with the defective product.

Repair Request Methods

http://www.toshiba-teli.co.jp/en/support/contact/failure_situation.htm

Please read the following instructions carefully.

1. Please return our product alone, taking out of your equipment in case that our product is installed to an equipment
2. We are unable to return the information such as your own serial numbers, control number, the identification seal, if it is attached to the returned products. Please keep record before you return the product.
3. As the data saved in the camera will not be kept after the repair, please take out data before return.
4. We are unable to accept the cancellation after the repair request by the customer's reason.
5. About the repair product shipping expenses, please bear the charges when you return the product to us. We bear the charges to you from us only for a warranty period.
6. We are unable to accept your request of a delivery date and time of the product return, or the delivery method.
7. We are unable to accept a trouble factor investigation, the request of the repair report.
8. We accept a repair of out of warranty product, if it is reparable.
9. The proprietary rights of the repair request products after the exchange repair belong to us.
10. The immunity from responsibility of the product is applied in the repair completion products.

* Please refer for the inquiry about the software to our website or sales personnel.

10 Outline Drawing

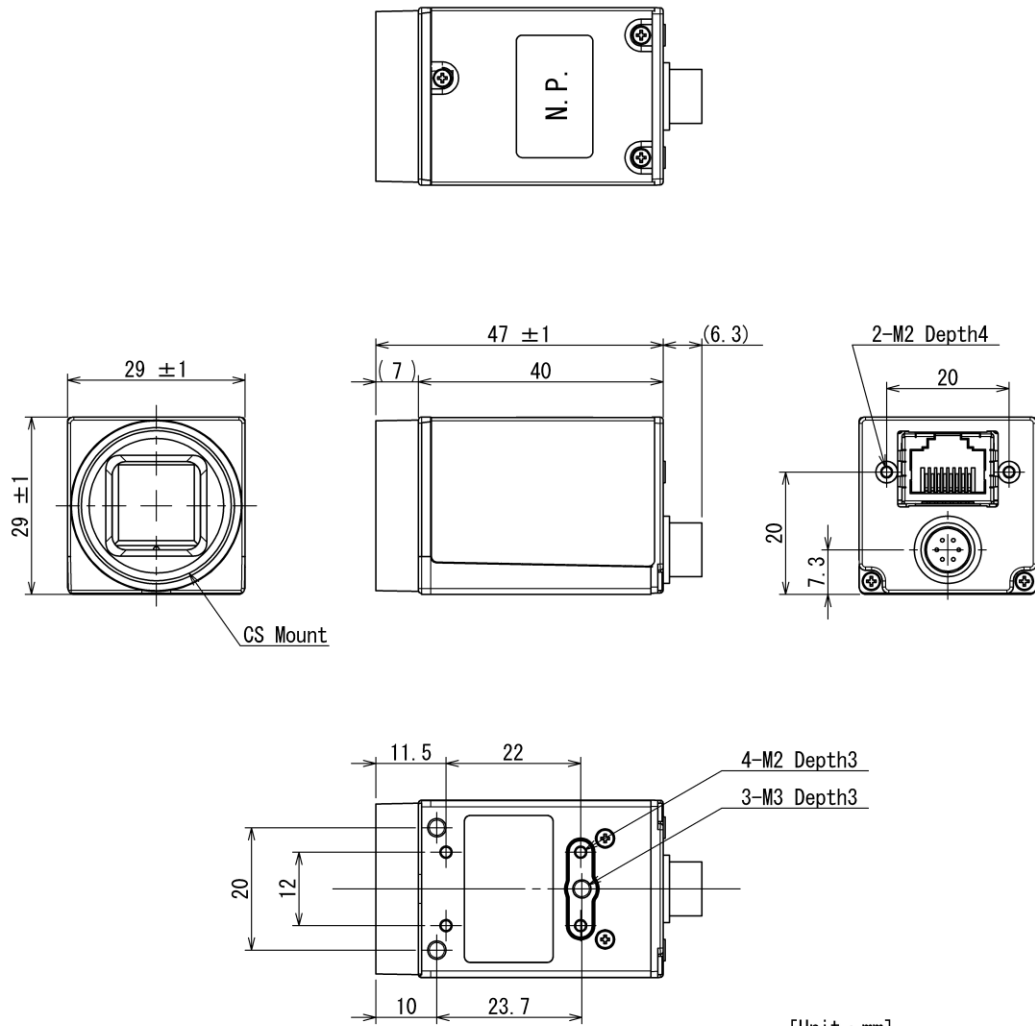

[Unit : mm]

Specification

Material

Lens mount, Rear panel : Aluminum die cast

Cover : Anticorrosion aluminum alloy

Processing

Lens mount, Cover, Rear panel: Cation coating (black)