



CCD Monochrome Video Camera

**CS8310Bi (EIA)
CS8310BCi (CCIR)
CS8311Bi (EIA)
CS8311BCi (CCIR)**

PRODUCT SPECIFICATION

Contents

Before use – General safety instructions	
1. Product Description	1
2. Features	1
3. Configuration	1
4. Specification	1
5. Connector pin assignment	5
6. External-View Drawing	6

TOSHIBA TELI CORPORATION

BEFORE USE - GENERAL SAFETY INSTRUCTIONS



This instruction manual contains important information for the operator (user) and/or people in the vicinity to avoid personal injury, or property damage.

- Prior to use, read this operation manual carefully to fully understand its instructions for correct use.
- After reading, keep this manual near the equipment for future reference.

WARNINGS & CAUTIONS



[Definition of markings]

The meaning of each mark used in this instruction manual is given below.

 WARNING	This mark warns the user that improper use may cause death or severe personal injury of the user or people in the vicinity.
 CAUTION	This mark warns the user that improper use may cause personal injuries (*1) or material damages (*2) against the user or people in the vicinity.

Notes *1: Personal injury means wounds, burns, electric shocks, and others for which hospitalization or long term care are not required.

*2: Material damage means any direct or consequential damage related to property or material loss.

	This mark indicates what the user SHOULD NOT DO . The details are given adjacent the mark.
	This mark indicates what the user MUST DO . The details are given adjacent the mark.

WARNING



unplug

- **Immediately cease use of the equipment in the event of abnormality or malfunction.**
If abnormal conditions are present, such as smoke, a burning smell, ingress of water or foreign matter, or if the equipment is dropped or malfunctions, fire or electric shock may result. If such abnormalities occur, disconnect the power plug from the outlet and contact your sales representative.
-



Do not get wet

- **Do not use the equipment in locations subject to water splashes.**
Otherwise, fire or electric shock may result.
-



Never pull apart

- **Do not disassemble, repair, or modify the equipment.**
Otherwise, fire or electric shock may result. For internal repair, inspection, or cleaning, contact your sales representative.
-



Avoid

- **Do not place anything on the equipment.**
If metallic objects, liquid, or other foreign matter enters the equipment, fire or electric shock may result.
-



Avoid

- **Do not install the equipment in an unstable or inclined location or locations subject to vibration or impact.**
Otherwise, the equipment may topple over and cause personal injury.
-



Do not touch

- **During an electrical storm, do not touch the power cord or connection cable.**
Otherwise, an electric shock may result.
-



Instruction

- **Use the specified power supply.**
Use of an unspecified power supply may result in fire or electric shock.
-



CAUTION



Instruction

- **Observe the following when installing the equipment:**

- Do not cover the equipment with a cloth, etc.
- Do not place the equipment in a narrow location where heat is likely to accumulate. Otherwise, heat will accumulate inside the equipment, possibly resulting in a fire.



Avoid

- **Do not place the equipment in locations subject to high moisture, oil fumes, steam, or dust.**

Otherwise, fire or electric shock may result.



Avoid

- **Do not install the equipment in locations exposed to direct sunlight or humidity.**

Otherwise, the internal temperature of the equipment will rise, which may cause a fire.



Avoid

- **Use only specified DC power cables and connection cables.**

Otherwise, fire or electric shock may result.



Avoid

- **When performing connection, turn off power.**

When connecting the power cable or connection cable, turn off the equipment power. Otherwise, fire or electric shock may result.



Instruction

- **Contact your sales representative to request periodic inspection and cleaning (every approx. five years).**

Accumulation of dust inside the equipment may result in fire or electric shock. For inspection and cleaning costs, contact your sales representative.

CASES FOR INDEMNITY (LIMITED WARRANTY)

We shall be exempted from taking responsibility and held harmless for damage or losses incurred by the user in the following cases.

- In the case damage or losses are caused by fire, earthquake, or other acts of God, acts by a third party, deliberate or accidental misuse by the user, or use under extreme operating conditions.
- In the case of indirect, additional, consequential damages (loss of business interests, suspension of business activities) are incurred as result of malfunction or non-function of the equipment, we shall be exempted from responsibility for such damages.
- In the case damage or losses are caused by failure to observe the information contained in the instructions in this instruction manual and specifications.
- In the case damage or losses are caused by use contrary to the instructions in this instruction manual and specifications.
- In the case damage or losses are caused by malfunction or other problems resulting from use of equipment or software that is not specified.
- In the case damage or losses are caused by repair or modification conducted by the customer or any unauthorized third party (such as an unauthorized service representative).
- Expenses we bear on this product shall be limited to the individual price of the product.

RESTRICTION FOR USE

- Should the equipment be used in the following conditions or environments, give consideration to safety measures and inform us of such usage:
 1. Use of the equipment in the conditions or environment contrary to those specified, or use outdoors.
 2. Use of the equipment in applications expected to cause potential hazard to people or property, which require special safety measures to be adopted.
- This product can be used under diverse operating conditions. Determination of applicability of equipment or devices concerned shall be determined after analysis or testing as necessary by the designer of such equipment or devices, or personnel related to the specifications. Such designer or personnel shall assure the performance and safety of the equipment or devices.
- This product is not designed or manufactured to be used for control of equipment directly concerned with human life (*1) or equipment relating to maintenance of public services/functions involving factors of safety (*2). Therefore, the product shall not be used for such applications.
 - (*1): Equipment directly concerned with human life refers to:
 - Medical equipment such as life-support systems, equipment for operating theaters.
 - Exhaust control equipment for exhaust gases such as toxic fumes or smoke.
 - Equipment mandatory to be installed by various laws and regulations such as the Fire Act or Building Standard Law
 - Equipment related to the above
 - (*2) Equipment relating to maintenance of public services/functions involving factors of safety refers to:
 - Traffic control systems for air transportation, railways, roads, or marine transportation
 - Equipment for nuclear power generation
 - Equipment related to the above

Usage Precautions

- **Handle carefully**

Do not drop the equipment or allow it to be subject to strong impact or vibration, as such action may cause malfunctions. Further, do not damage the connection cable, since this may cause wire breakage.

- **Environmental operating conditions**

Do not use the product in locations where the ambient temperature or humidity exceeds the specifications. Otherwise, image quality may be degraded or internal components may be adversely affected. In particular, do not use the product in areas exposed to direct sunlight. Moreover, during shooting under high temperatures, vertical stripes or white spots (noise) may be produced, depending on the subject or camera conditions (such as increased gain). However, such phenomena are not malfunctions.

- **Do not shoot under intense light.**

Avoid intense light such as spot lights on part of the screen because it may cause blooming or smears. If intense light falls on the screen, vertical stripes may appear on the screen, but this is not a malfunction.

- **Occurrence of moiré**

If you shoot thin stripe patterns, moiré patterns (interference fringes) may appear. This is not a malfunction.

- **Occurrence of noise on the screen**

If an intense magnetic or electromagnetic field is generated near the camera or connection cable, noise may be generated on the screen. If this occurs, move the camera or the cable.

- **Handling of the protective cap**

If the camera is not in use, attach the lens cap to the camera to protect the image pickup surface.

- **If the equipment is not to be used for a long duration**

Turn off power to the camera for safety.

- **Maintenance**

Turn off power to the equipment and wipe it with a dry cloth.

If it becomes severely contaminated, gently wipe the affected areas with a soft cloth dampened with diluted neutral detergent. Never use alcohol, benzene, thinner, or other chemicals because such chemicals may damage or discolor the paint and indications.

If the image pickup surface becomes dusty, contaminated, or scratched, consult your sales representative.

- **Disposal**

When disposing of the camera, it may be necessary to disassemble it into separate parts, in accordance with the laws and regulations of your country and/or municipality concerning environmental contamination.

1. Product Description

Model CS83xxi is a miniature camera series featuring its ultra-small light-weight body. The CS83xxi camera series is designed mainly for factory automation, machine vision, and image measurement application.

2. Features

(1) High resolution

The 380,000 pixel CCD realizes the horizontal resolution of 570TV lines.

High-density images with minimum moire-fringes & beatings are obtained. (CCIR: 440,000 pixels, 560TV lines)

(2) Ultra-compact & light-weight body

The camera features its ultra-small light-weight body. Its super-small body will free you from much of your space restriction problem. The camera is driven by DC12V.

(3) Electronic shutter mode

The built-in electronic shutter allows this camera to capture a fast-moving object clearly and sharply

(4) AGC (Automatic Gain Control)

This series is equipped with AGC function. With the AGC, the camera obtains optimal images constantly even when the amount of incoming light fluctuates.

(5) Restart/Reset

When the restart/reset function set ON, the camera captures images at any timing given by R.R. pulse input (VD input).

(6) SS (Special shutter) & RTS (Random trigger shutter)

This camera is fitted with special shutter and random trigger shutter function, which allows the camera to capture images cued by external trigger input.

3. Configuration

(1) Camera body	1
(2) Operation manual	1
(3) Ferrite core	1

4. Specifications

(1) TV system		
CS8310Bi, CS8311Bi		Based on EIA standard
CS8310BCi, CS8311BCi		Based on CCIR standard
(2) Image sensor Interline CCD		
• Active pixel		
CS8310Bi, CS8311Bi	768 (H) × 494 (V)	
CS8310BCi, CS8311BCi	752 (H) × 582 (V)	
• Chip size		
CS8310Bi, CS8311Bi	11.6 μm × 13.5 μm	
CS8310BCi, CS8311BCi	11.6 μm × 11.2 μm	
• Active image area	8.8mm (H) × 6.6mm (V)	(equivalent to type-2/3 normal optical image size respectively.)
(3) Number of scanning lines		
CS8310Bi, CS8311Bi	525 lines	
CS8310BCi, CS8311BCi	625 lines	
(4) Scanning system	2 : 1 interlace	
(5) Sync. System	Internal/External	(automatic change over)
(6) Scanning frequencies		
Horizontal drive (H)		
CS8310Bi, CS8311Bi	15.734 kHz	
CS8310BCi, CS8311BCi	15.625 kHz	
Vertical drive (V)		
CS8310Bi, CS8311Bi	59.94 Hz	
CS8310BCi, CS8311BCi	50 Hz	

(7) Aspect ratio	4 : 3
(8) Sensitivity	
Standard	100 lx at F4, 3100 K, (Gain ; FIX, Gamma = 1.0)
Minimum	0.3 lx at F1.4, 3100 K, (Gain ; MAX., Gamma = 0.45)
(9) Video output	
VS (Video + SYNC)	1.0 V(p-p)/75 Ω
(10) Resolution	
Horizontal direction	
CS8310Bi,CS8311Bi	570 TV lines
CS8310BCi,CS8311BCi	560 TV lines
Vertical direction	
CS8310Bi,CS8311Bi	485 TV lines
CS8310BCi,CS8311BCi	575 TV lines
(11) S/N (luminance)	56 dB(p-p)/rms or more (Gain ; FIX Gamma = 1.0)
(12) Input signal	
External sync pulses	
HD,VD,R.R and SYNC	4.0 ± 2.0 V(p-p)
Input impedance	75 Ω / HIGH selection can be made using the internal switch. (Factory setting : HIGH)
Pulse polarity	Negative polarity
Pulse width	
HD	6.4 ± 3 μ s
VD	150 to 800 μ s
Frequency	
Horizontal (fH)	
CS8310Bi,CS8311Bi	15.734 kHz ± 2 %
CS8310BCi,CS8311BCi	15.625 kHz ± 2 %
Vertical (fV)	
CS8310Bi,CS8311Bi	2fH/525
CS8310BCi,CS8311BCi	2fH/625
Number of scanning lines	
CS8310Bi,CS8311Bi	525 lines
CS8310BCi,CS8311BCi	625 lines
Phase between HD/VD	The phase relation between HD and VD should be as shown below.

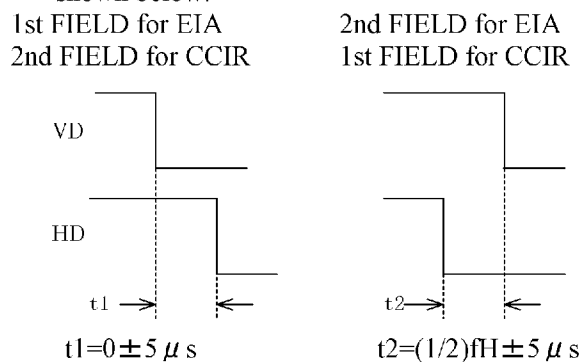

(13) Output signal	
Clock pulse	The clock pulse is available, if necessary.
Pulse level	3.0V(p-p)/high impedance
Frequency	
CS8310Bi,CS8311Bi	14.318181 MHz ± 100ppm
CS8310BCi,CS8311BCi	14.1875 MHz ± 100ppm
HD/VD pulses	
Pulse level	4.5V(p-p)/high impedance
Interlace	2 : 1
Polarity	Negative

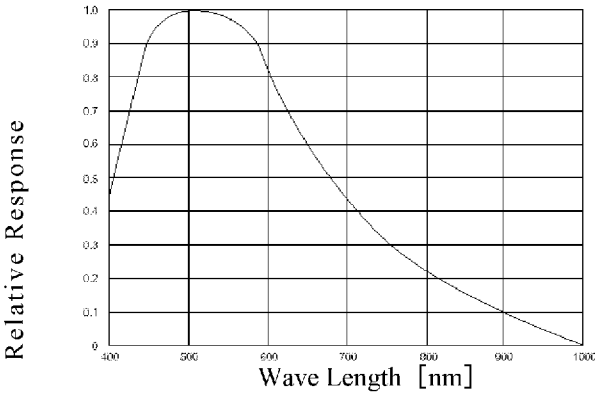
Pulse width HD CS8310Bi,CS8311Bi CS8310BCi,CS8311BCi VD CS8310Bi,CS8311Bi CS8310BCi,CS8311BCi Frequency Horizontal (fH) CS8310Bi,CS8311Bi CS8310BCi,CS8311BCi CS8310Bi,CS8311Bi CS8310BCi,CS8311BCi (14) Sensitivity setting (15) AGC Operating range (16) MGC (17) Gamma correction (18) White clip (19) Electronic shutter (20) Special shutter (21) CCD operation mode (22) Restart (23) Spectral response (24) Power source (25) Power consumption CS8310Bi,CS8310BCi CS8311Bi,CS8311BCi (26) Ambient condition (27) Lens mount	6.36±0.1 μ s 6.41±0.1 μ s 572±1 μ s 480±1 μ s 15.73426 kHz ±2 Hz 15.625 kHz ±2 Hz 2fH/525 2fH/625 The following modes can be set using the panel selection switch. (Factory setting ; FIX) FIX (FIX Gain); Standard sensitivity setting. AGC (Automatic Gain Control) MGC (Manual Gain Control) Stabilized by AGC within 2 dB for +6 dB or -12 dB of the output signal variation Sensitivity can be set manually. 0.45/1.0 selectable Clip level should be set for 1.0V at factory, excluding SYNC tip. ON/OFF selectable Shutter speed 1/125, 1/250, 1/500, 1/1000, 1/2000, 1/4000, 1/10000 sec and flicker-less (1/100 or 1/120) Any shutter timing and shutter speed can be set according to the shutter trigger and R.R pulse inputs. This function can be turned ON/OFF by an internal switch. (Factory setting ; OFF) Field or frame store mode can be selected as necessary. (initially preset frame mode in factory) Provides ON/OFF switch inside of the camera. Refer below.  DC12V ±10 % (within 10mV(p-p) ripple) approx. 220 mA approx. 270 mA Temperature 0 °C to + 40 °C Humidity less than 90 % C-mount
--	---

(28) Dimensions

CS8310Bi,CS8310BCi
CS8311Bi,CS8311BCi

44(W)×29(H)×78(D) mm (refer to pages 25)
• Camera head 44(W)×29(H)×32.5(D) mm
• CCU 44(W)×29(H)×64(D) mm
• Camera cable 600mm

(29) Weight

CS8310Bi,CS8310BCi
CS8311Bi,CS8311BCi

approx. 130 g

- Camera head
- CCU

approx. 70 g

approx. 90 g

(30) Optional Accessories

- AC power adapter

CA130C-01 AC 100V ±10%

CA140B AC 220V ±10%

DC12V, 0.9A

Dimensions

CA130C-01 92 (W)×68 (H)×120 (D) mm

CA140B 125 (W)×60 (H)×130 (D) mm

Weight approx. 1 kg

- Cable for AC power adapter

CPC3440-03 (3m)

CPC3440-05 (5m)

CPC3440-10 (10m)

- BNC video cable

* Make choice of the most appropriate cables, according to your system or application.

5. Connector pin assignment

The connector is combined with DC12V input, and some other, and recommended to use the system including an image processor.

They are composed of 12 pins, and the pin assignment is as followings.

●Camera connector : HR10A-10P-12S (Maker : Hirose denki)

Pin No	External synchronization			Internal synchronization
	HD and VD	VS/SYNC	Restart • Reset	
1	GND	GND	GND	GND
2	+12V	+12V	+12V	+12V
3	Video output (GND)	Video output (GND)	Video output (GND)	Video output (GND)
4	Video output (signal)	Video output (signal)	Video output (signal)	Video output (signal)
5	HD input (GND)	————	HD input (GND)	HD output (GND)
6	HD input (signal)	————	HD input (signal)	HD output (signal)
7	VD input (signal)	VS/SYNC input (signal)	R • R input (signal)	VD output (signal)
8	Shutter trigger input/ Clock output (GND)	Shutter trigger input/ Clock output (GND)	Shutter trigger input/ Clock output (GND)	Shutter trigger input/ Clock output (GND)
9	Shutter trigger input/ Clock output (signal)	Shutter trigger input/ Clock output (signal)	Shutter trigger input/ Clock output (signal)	Shutter trigger input/ Clock output (signal)
10	GND	GND	GND	GND
11	+12V	+12V	+12V	+12V
12	VD input (GND)	VS/SYNC input (GND)	R • R input (GND)	VD output (GND)

* HD,VD output is available for internal switch selection.

* Clock output is available for internal switch selection.

The clock output cannot be made when the shutter trigger is being input (when the special shutter function is being used).

(1) DC12V input

Connect pin number 2 and/or 11 for DC12V (HOT) and Pin 1 and/or 10 for GND.

(2) Video output

Composite EIA or CCIR video output (VS) is output from 4 (HOT) and 3 (GND).

CAUTION

There are two video output which are from VIDEO OUT (BNC) and DC IN/SYNC pin 4-3 (GND).

Do not use both of them at the same time, because it may occur double termination with the video output, and the video output will be half.

(3) Input pulses for external sync

When required external sync-operation between other equipments, use either one of pulses for HD/VD, VS or SYNC. And input HD pulse from pin number 6-5 (GND) and VD from pin 7-12 (GND) for HD/VD external sync operation. And input VS or SYNC from pin 7 and 12 (GND) for external sync operation by VS or SYNC.

(4) Clock pulse

Clock Pulse is come out from pin 9-8(GND) when the system required it.

6. External-view Drawing

(1)CS8310Bi,CS8310BCi

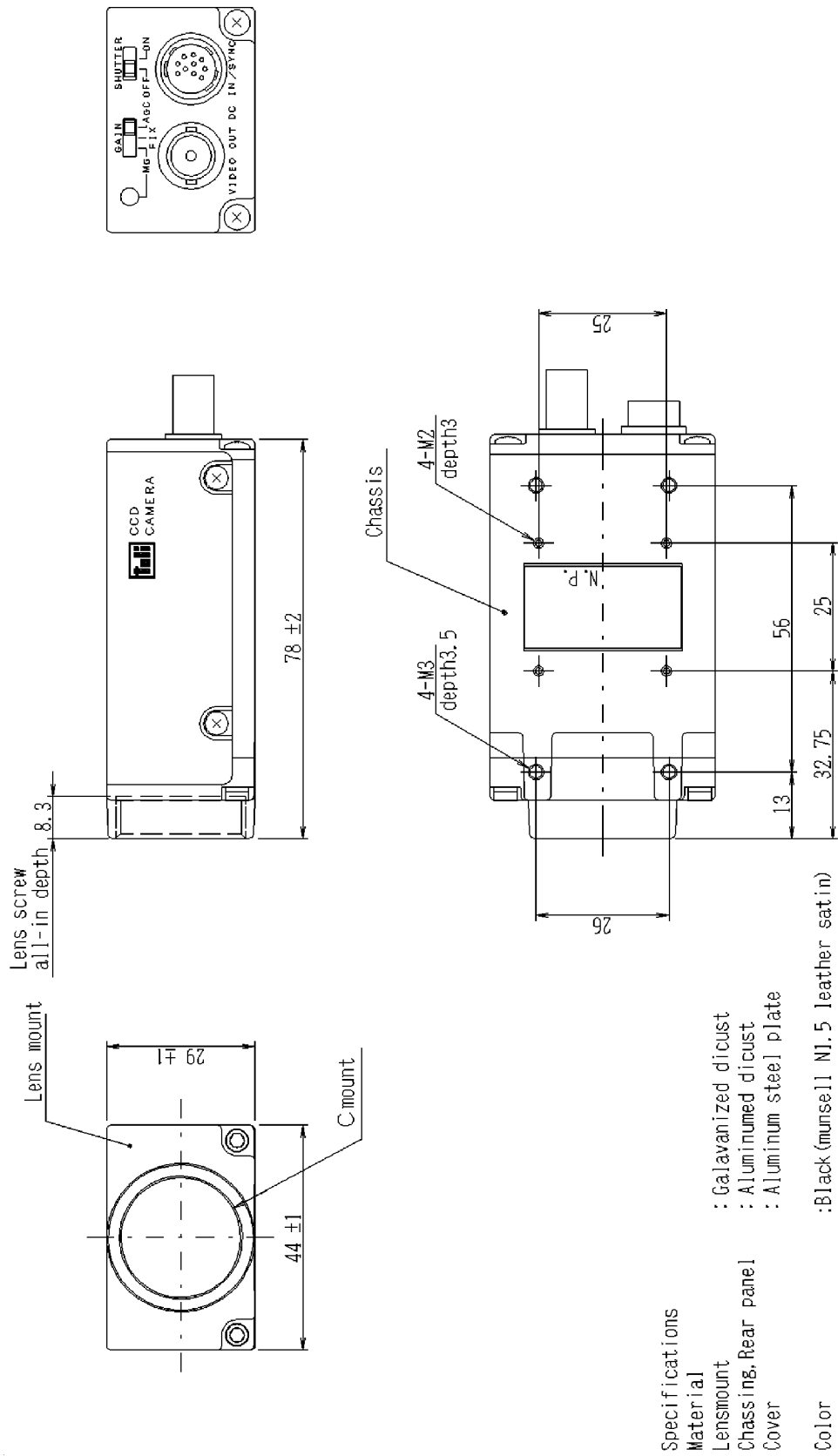

(2)CS8311Bi,CS8311BCi

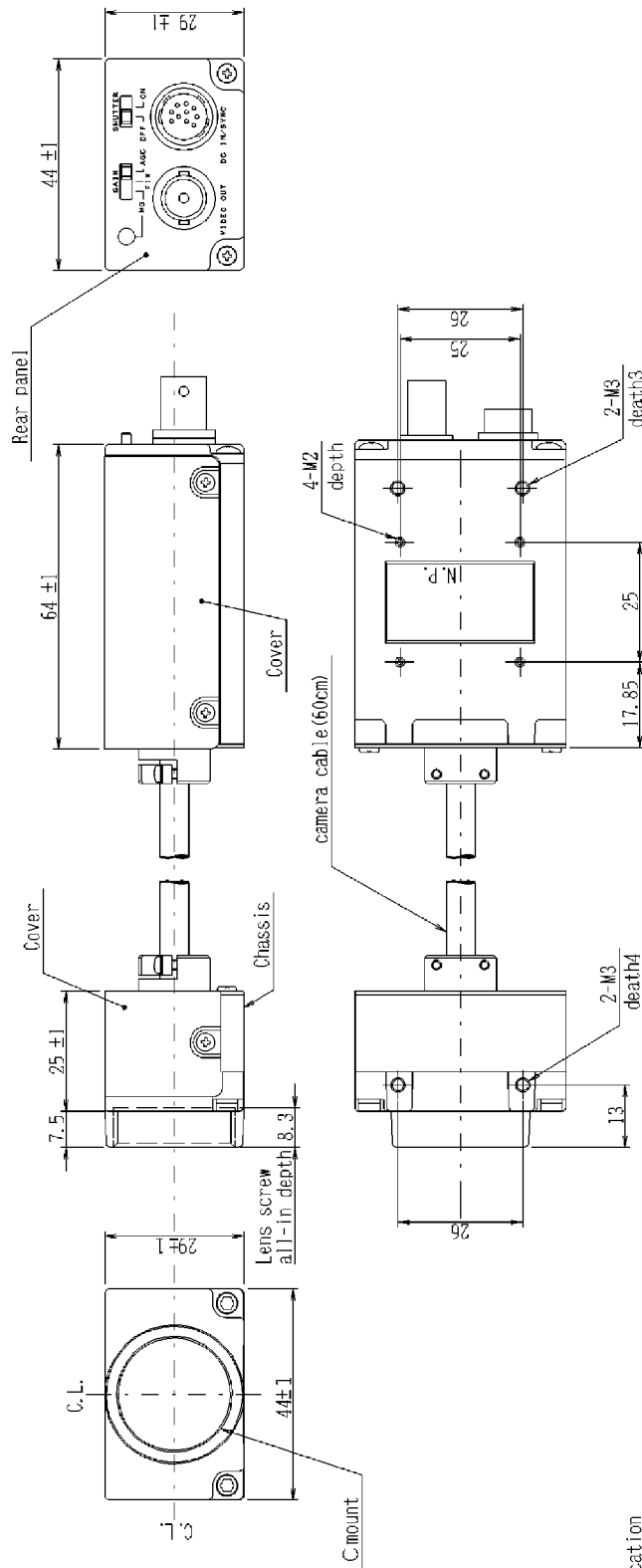

Specification
Material

- Camera head :Galvanized dicust
- Lensmount :Aluminomed dicust
- Chassing :Aluminum steel plate
- Cover, Rear panel :Aluminum steel plate
- Camera control unit :Aluminomed dicust
- Chassing, Rear panel :Aluminum steel plate
- Cover

Color :Black (murse) || NI.5 leather (atin)