



# B/W CCD Camera Model CS8550i-51 Operation Manual

Thank you for purchasing our CS8550i-51 B/W CCD camera. This operation manual contains many important information such as how to use this equipment correctly and safely. Please read through this manual carefully. After reading, keep this manual by the side of your equipment for your future reference.

## TOSHIBA TELI CORPORATION

### BEFORE USE - GENERAL SAFETY INSTRUCTIONS

This instruction manual contains important information for the operator (user) and/or people around him/her to avoid personal injury, or property damage to him/her or people around him/her by using this product correctly. Prior to use, read this operation manual carefully to fully understand its instructions for correct use.

### OWNER'S RECORD

Please fill in the blank below the model name and product serial number, which is found on bottom chassis of your device. Keep this number for your record.

Model Name \_\_\_\_\_

Serial No. \_\_\_\_\_

### WARNINGS & CAUTIONS

[Definition of markings]  
The meaning of each mark used in this instruction manual is given below.

	<b>DANGER</b> This mark warns the user that improper use, indicated with this mark, may cause death or severe personal injuries against the user or people around him/her.
	<b>CAUTION</b> This mark warns the user that improper use, indicated with this mark, may cause personal injuries (*1) or material damages (*2) against the user or people around him/her.

- Notes
- \*1 : Personal injuries mean wounds, burns, electric shocks, and others for which the person injured need not to be hospitalized nor to be cared for the long term.
  - \*2 : Material damages mean any direct or consequential damages related to property or material loss.

	This mark indicates what the user <b>SHOULD NOT DO</b> . The details of things which the user should not do are described next to this mark.
	This mark indicates what the user <b>MUST DO</b> . The details of things which the user must do are described next to this mark.
	This mark indicates that the user must be alert against a possible <b>DANGER</b> . The details of the danger which the user must be aware of are described next to this mark.
	This mark indicates that the user are given a <b>CAUTION</b> against possible hazards. The details of the caution which the user must be aware of are described next to this mark.

### Handling Precautions

	<b>DANGER</b> <b>If any overheating sign is observed, discontinue use immediately.</b> In the event that smoke, smell, or any other overheating sign is observed, turn its power switch OFF immediately, and remove its camera cable from camera connector. Do NOT try to continue to use your camera. To do so in spite of a clear sign of a malfunction invites a fire, an electric shock hazard, or any other serious damage. In such case, after confirming that there is no risk of a fire accident, contact us or our dealer/distributor through which you purchased this device for repair service. To avoid hazard, do NEVER attempt to repair it yourself.
	<b>If any malfunctioning sign is observed, discontinue use immediately.</b> Do NOT try to use this device when it is obviously malfunctioning. (Example: No images on the monitor) In the event of a malfunction, turn its power switch OFF immediately, and remove its camera cable from camera connector. In such case, contact us or our dealer/distributor through which you purchased this device for repair service.
	<b>If any liquid gets into the device, discontinue use immediately.</b> In the event that water, or any other type of liquid gets into the body, do NOT try to continue to use the device. To do so invites a fire or an electric shock hazard. In such case, turn its power switch OFF immediately, and then remove its camera cable from camera connector. After that, contact us or our dealer/distributor through which you purchased this device for repair service/technical advice.
	<b>Do NOT disassemble this device.</b> Do NOT attempt to pull apart, repair, or modify your camera yourself. To do so might lead to a fire or an electric shock accident. Contact us or the dealer/distributor from which you purchased the device for repair/modification.
	<b>Do NOT supply any power other than specified.</b> This device is designed to work only under specified voltage. Do NOT attempt to supply the device with power other than specified. Supplying the device with any unspecified power invites a fire or an electric shock hazard. (CS8550i-51 --- DC+12V)
	<b>Do NOT use the camera in a high-humidity environment.</b> Do NOT place your camera near a humidifier, or in other high-humidity environment. To do so might cause a fire or an electric shock accident.
	<b>Do NOT use any optional unit other than manufacturer-supplied one.</b> We disclaim any responsibility for damages or losses incurred by user due to the use of unauthorized / unofficial option units supplied by a third-party.

### Handling Precautions

	<b>CAUTION</b> If the camera is operated in the electromagnetic field, there may be cases where beat noises (vertical, horizontal, or oblique stripes) appear in the video output. In that case, take preventive measures on the electromagnetic-wave generating source so that your camera do not receive the interference by the electromagnetic-wave. Take extra precautions against electromagnetic-wave-interference if your camera is used with a servomotor, inverter, or other electromagnetic-wave-generating equipment.
	Avoid giving a strong shock against the camera body. It might cause a breakdown or damage. If your camera is used in a system where its camera head is subjected to strong repetitive shocks, its camera head is possible to break down. If you intend to use your camera in such a situation, make sure to use an optional camera-connector-fixing-hardware to connect the connector-plug to the camera body.
	When the camera is not in use, put a lens or a lens-cap onto the camera head so that the image pickup plane of CCD is protected from dust, foreign object, or any other flaw-causing object. If the glass plane (image pickup plane) gets dirty, clean it with a cotton swab. When it needs to be cleaned with a cleaner, be sure NOT to use any organic solvent other than ethyl alcohol. As a countermeasure against condensation, when the camera is moved from a warm condition/environment to a cold one, take appropriate precautions to prevent condensation from forming on the camera.
	Do not pull strongly the camera cable/camera-head nor swing it. The stress from pulling or swinging may cause damage in the coating of the cable, or breaks in the inside wires.
	Avoid short-circuiting signal output. Otherwise, it may cause a malfunction.
	If too much amount of light, (= the incoming light amount of 100 times or greater in comparison with standard light) enters CCD image pickup plane, video output might not be obtained. In such a case, take measures to reduce the amount of incoming light.
	Do NEVER expose its camera head to any intensive light (such as direct sunlight). Otherwise, its inner image pickup device might get damaged.

<b>CAUTION</b>	
	When mounting a lens, take extra caution so that the lens is not tilted, nor does flaw exist at the lens-mount-screw part. Also check to confirm that no dirt nor other foreign object is put inside. Improper mounting might cause the parts to become locked.
	Wastes of this product should be separated and discarded in compliance with the various national and local ordinances.

### RESTRICTION FOR USE

In the case where a malfunction of this camera (e.g. video output cut-off) can be expected to lead to a significant accident, avoid using this device for such system build-in use.

### DISCLAIMER (LIMITED WARRANTY)

We assume no responsibility and shall be held harmless for damage or loss incurred by the user in the following cases.

- In the case where damage or loss is caused by fire, earthquake, or other acts of Gods, acts by a third party, misuse by the user deliberately or erroneously, or use under extreme operating conditions.
- In the case where any indirect, additional, consequential damages (e.g. loss of expected interest, suspension of business activities) are incurred as results of a malfunction or non-functioning of this device, we shall be exempted from assuming responsibility for such damages.
- In the case where damage or loss is caused by incorrect use which is not in line with the instructions given in this operation manual.
- In the case where damage or loss is caused by a malfunction resulting from bad connection with other equipment.
- In the case where damage or loss is caused by repair or modification done by the user.

<b>IMPORTANT SAFETY INSTRUCTIONS</b>	
(1)	This device is designed and guaranteed to work under the temperature range of 0 through 40 degree C. Avoid using the equipment beyond that limits.
(2)	Do NOT expose the camera's image-pickup-plane to sunlight or other intense light directly. Its inner CCD (charge-coupled device) might be damaged.
(3)	In the event that any abnormal condition is observed, turn the power switch OFF immediately. Do NOT try to continue to use the camera. To do so in spite of clear signs of malfunction invites a fire, an electric shock hazard, or any other serious damage to the camera. In such case, contact us or our dealer/distributor from which you purchased the camera for repair service.
(4)	To clean the body of this equipment, make sure to turn the power switch OFF first. To remove stubborn stains, use a soft cloth soaked in diluted acid-free detergent. After that, clean with a dry cloth.
(5)	In case the image-pickup-plane should be settled with fine dust, dirt, or scratched, ask our distributor for technical advice.

Following information is only for EU-member states:

The use of the symbol indicates that this product may not be treated as household waste. By ensuring this product is disposed of correctly, you will help prevent potential negative consequences for the environment and human health, which could otherwise be caused by inappropriate waste handling of this product. For more detailed information about the take-back and recycling of this product, please contact your supplier where you purchased the product.

	"This symbol is applicable for EU member states only"
--	---

This device complies with Part 15 of the FCC rules. Operation is subject to the following two conditions: (1) This device may not cause harmful interference, and (2) This device accept any interference received, including interference that may cause undesired operation.

This equipment has been tested and found to comply with the limits for a class A digital device, pursuant to Part 15 of the FCC Rules. These limits are designed to provide reasonable protection against harmful interference when the equipment is operated in a commercial environment. This equipment generates, uses, can radiate radio frequency energy and, if not installed and used in accordance with the instruction manual, may cause harmful interference to radio communications. Operation of this equipment in a residential area is likely to cause harmful interference in which case the user will be require to correct the interference at his own expense.

### 1. PRODUCT DESCRIPTION

Model CS8550i-51 is a one-body type B/W CCD camera with a VGA format all-pixel-data readout CCD. The model is suited for high-speed, high-resolution image processing use. Its compact, light-weight body is ideal for system integration.

### 2. FEATURES

- All pixel's data readout  
With its built-in all-pixel-data-readout CCD, this model can read out image-data just in approximately 1/30 sec. A frame-shutter reads out all data even under RTS (Random Trigger Shutter) mode.
- High vertical resolution  
As all pixel's data are read out even under RTS mode (in 1/30 sec.), images with no deterioration in vertical resolution are obtained.
- Square grid pattern CCD  
Pixel's in CCD are aligned in square grid pattern. This makes it easier to perform computation correctly for image processing use.
- External Sync  
The camera is switched over to external synchronization operation automatically when external HD signal is input.
- Random trigger shutter function  
With a built-in RTS, the camera's CCD starts light-exposure in synchronization with external trigger signals. This function enables the camera to capture fast-moving subjects at constant position for precise image processing.
- Restart / Reset  
Under the restart / reset mode, this model can capture images at an arbitrary timing cued by external VD signal.
- Multiple shutter  
With this shutter, this model capture images at an arbitrary timing cued by external trigger signal, and then outputs video at an arbitrary timing cued by external VD signal.
- Partial-scan  
Under the partial scan mode, only 1/2 or 1/4 screen center portion of image information is read out, resulting in a faster operation.
- Ultra-compact & light-weight camera head  
The model features its ultra-compact and light-weight camera head, freeing you from your integration-space-problem. In addition, it has an excellent shock and vibration resistance.

### 3. CONFIGURATION

- Camera body ..... 1
- Accessory Manual ..... 1

### 4. OPTION UNIT

- DC SYNC IN cable.....Model name : CPCR3700 [2m,3m,5m,10m]
- Camera adapter.....Model name : CA130C-01
- Camera-mounting kit .....Model name : CPT8550
- Camera-connector fixing hardware

\*Contact your dealer / distributor for details of option units.

\*Conformity of an option part and EMC conditions

About the conformity of EMC standard of this machine, it has guaranteed in the conditions combined with the above-mentioned option part. When used combined parts other than specification of our company, I ask you to have final EMC conformity checked of a visitor with a machine and the whole equipment.

### 5. OPERATION MODE

- GAIN selection (Camera rear-panel SW [GAIN])  
Switches sensitivity setting
  - FIX.....Factory-prefixed gain [F]
  - MANU.....Gain is adjustable via the manual gain potentiometer (M.GAIN) [M]
- Video output mode selection (Camera rear-panel DIP SW [VIDEO])  
Switches video format
  - 1/30: 1/30s.....Non-interlace mode  
As all pixels are read out in 1/30s, you will get images with the higher V resolution
  - 1/60: 1/60s.....2:1 interlace MIX mode  
As vertical pixels are added in readout, the sensitivity is same as that of 1/30s non-interlace mode during electronic shutter OFF. Twice greater sensitivity is obtained under shutter-speed range of 1/100 - 1/10000.
- TRIG selection (Camera rear-panel DIP SW [TRIG])  
Switches TRIG input signal polarity used under RTS mode
  - POS.....Positive polarity (rising edge detection)
  - NEG.....Negative polarity (falling edge detection)
- RTS (Random Trigger Shutter) exposure selection [EXP]  
Switches light exposure mode under RTS mode
  - FIX mode.....Rear DIP SW  
Exposure-time control via rear-panel DIP switch
  - PULSE W mode.....TRIG signal pulse width control  
Exposure-time control via TRIG signal pulse width
- Shutter mode selection (Camera rear-panel DIP SW [SMODE] or TRIG signal IN [Automatic])  
Switches shutter mode
  - NOR mode.....Normal electronic shutter  
Exposure control via internal sync signal  
High-speed shutter: From 1/10,000s through OFF (8 position)
  - RDM mode.....Random trigger shutter  
Exposure control via ext. trigger or ext. sync. input  
Timing charts are shown below. (TRIG timing: Positive)  
Notes: \* RDM selection is automatic with TRIG status  
\*\* Neither under FIX nor PULSE W mode, RTS doesn't work if E-shutter speed SW is set in OFF position.

(a) Non-reset mode (Under internal sync / external sync --- Consecutive VD IN)  
Exposure starts at the timing of TRIG signal IN. After each exposure is completed, the camera outputs video at each next VD IN timing.

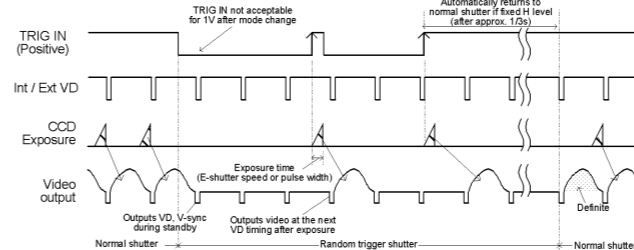

(b) Non-reset mode (Under external sync --- Single VD IN)  
After TRIG IN and exposure, the camera goes into standby until next ext. VD IN. Under 1/60s 2:1 interlace mode, video output field (ODD/EVEN) is determined by ext. VD falling edge and ext. HD phase.

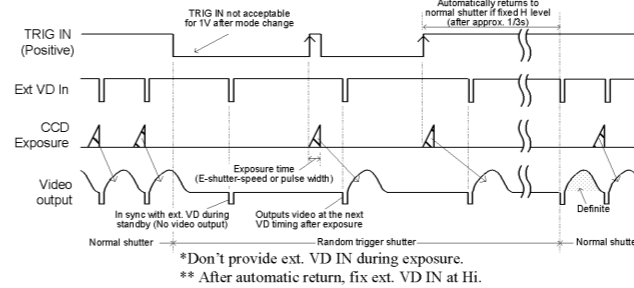

(c) V-reset mode (Under internal sync / external sync --- No VD IN)  
Exposure starts at the timing of TRIG signal IN. After each exposure is completed, the camera outputs video immediately by resetting VD. (HD is not reset) Under 1/60s 2:1 interlace mode, irrespective of TRIG IN phase, the camera always outputs ODD field image.

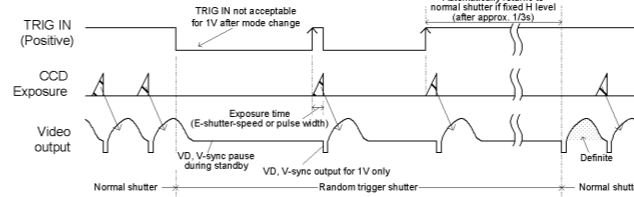

(d) SYNC reset mode (Under internal sync)  
Exposure starts at TRIG signal input timing, resets HD, and outputs video immediately after exposure by resetting VD.  
\* Available under FIX mode, irrespectively.

Under 1/60s 2:1 interlace mode, irrespectively of TRIG IN phase, the camera always outputs ODD field image.

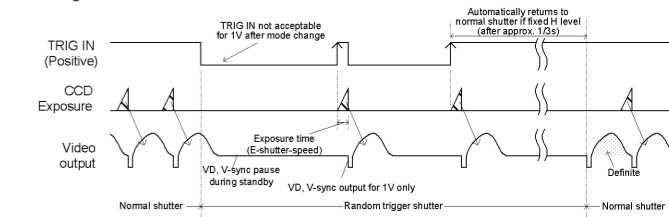

(5-3) MULTIPLE mode  
Multiple shutter operation is available by providing TRIG IN more than one time before ext. VD IN. (Non-reset mode, single VD, consecutive VD IN)

Under 1/60s 2:1 interlace mode, video output field (ODD/EVEN) is determined by ext. VD falling edge and ext. HD phase.

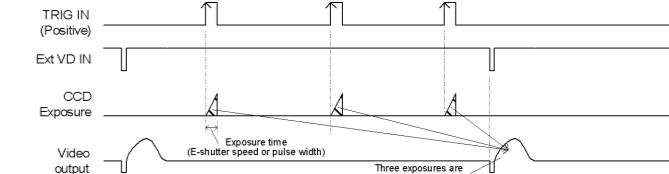

(5-4) Restart / Reset  
The restart / reset function is available with the ext. VD signal. You can get an arbitrary slower shutter speed than normal shutter and random trigger shutter. Here are some notes:

- \* The shutter speed (exposure time) is determined by ext. VD signal interval.
- \*\* This function is enabled when the rear-panel shutter speed DIP SW is OFF.
- \*\*\* Supply consecutive VD.

Under 1/60s 2:1 interlace mode, video output field (ODD/EVEN) is determined by ext. VD falling edge and ext. HD phase.

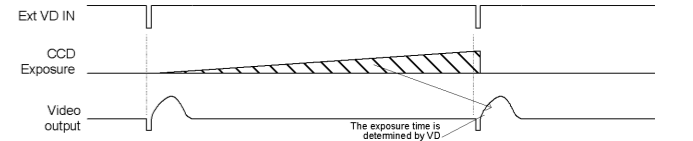

(6) Partial-scan mode selection (Camera rear-panel DIP SW [PART])

Switches partial-scan mode  
Note: Sometimes phenomenon called as "whiteout" occurs at the top of the screen when there is strong incident light entering in the wide area of a CCD, however, this is not a malfunction. If this occurs, reduce the amount of incoming rays.

(6-1) 1/2 Partial-scan (Rear-panel SW: 7-OFF, 8-ON) --- Screen center 1/2 readout

□ 1/30s Non-interlace  
Under 1/30s non-interlace mode, only the center portion of 227H out of the total effective lines 494H (excluding BLK time) is read out. Available both under external / internal mode.

Under normal shutter (Electronic shutter OFF)  
Notes: \* Under ext. sync, the ext. VD should be 1V = 262H.  
\*\* Under normal shutter, set the rear-panel DIP SW #5, #6 in OFF.

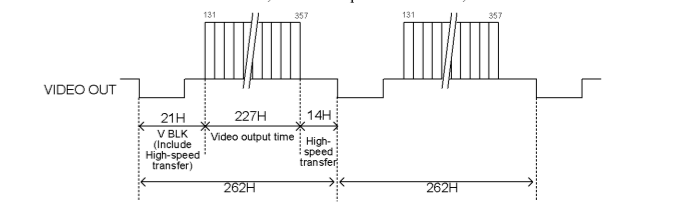

■ Under other shutter modes

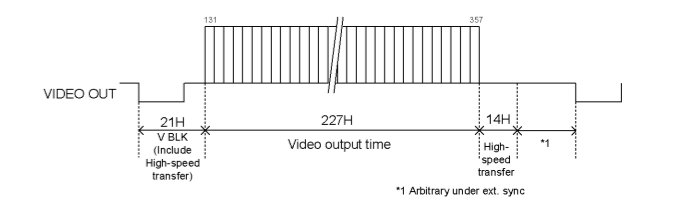

□ 1/60s 2:1 Interlace  
Under 1/60s interlace mode, only the center portion of 207H out of the total effective lines 485H (excluding BLK time) is read out. Available both under external / internal mode.

■ Under normal shutter (Electronic shutter OFF)  
Notes: \* Under ext. sync, the ext. VD should be 1V = 131.5H.  
\*\* Under normal shutter, set the rear-panel DIP SW #5, #6 in OFF.

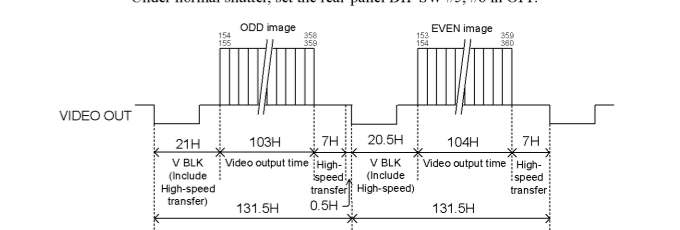

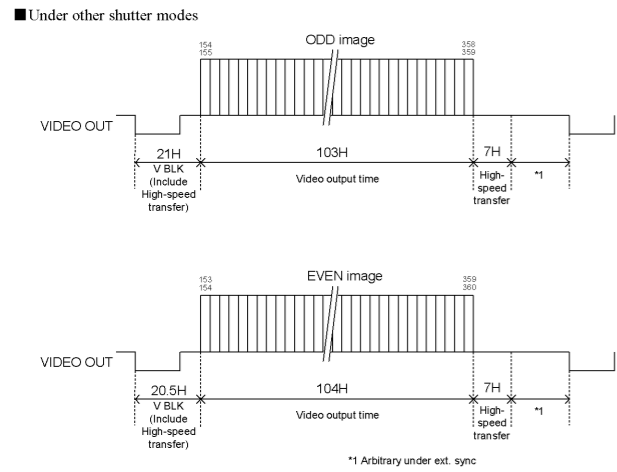

(6-2) 1/4 Partial-scan (Rear-panel SW: 7-ON, 8-ON) --- Screen center 1/4 readout  
 □ 1/30s Non-interlace  
 Under 1/30s non-interlace mode, only the center portion of 81H out of the total effective lines 494H (excluding BLK time) is read out. Available both under external / internal mode.

■ Under normal shutter (Electronic shutter OFF)  
 Notes: \* Under ext. sync, the ext. VD should be 1V = 131H.  
 \*\* Under normal shutter, set the rear-panel DIP SW #5, #6 in OFF.

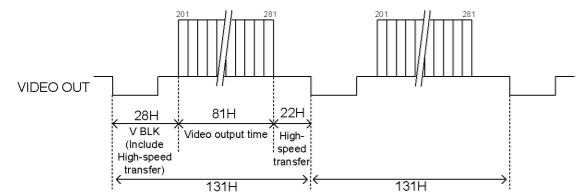

■ Under other shutter modes

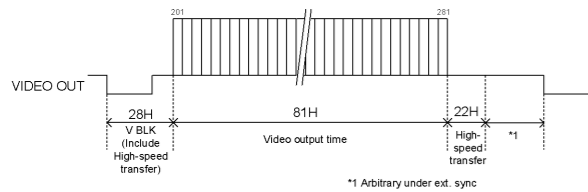

□ 1/60s 2:1 Interlace  
 Under 1/60s interlace mode, only the center portion of 61H out of the total effective lines 485H (excluding BLK time) is read out. Available both under external / internal mode.

■ Under normal shutter (Electronic shutter OFF)  
 Notes: \* Under ext. sync, the ext. VD should be 1V = 65.5H.  
 \*\* Under normal shutter, set the rear-panel DIP SW #5, #6 in OFF.

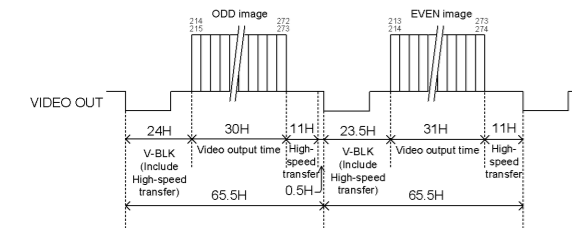

■ Under other shutter modes

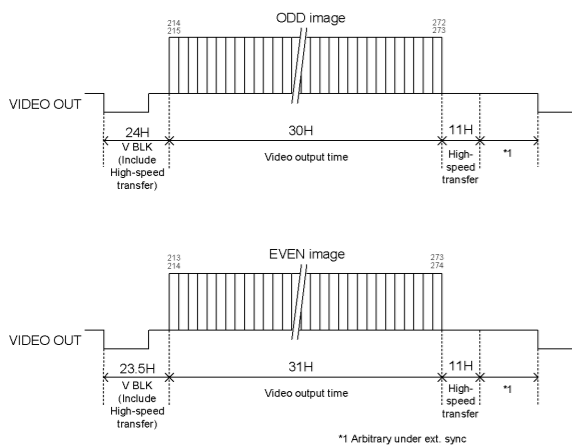

## 6. SPECIFICATIONS

- [Basic spec]  
 (1) Image sensor  
 Total pixels: 692(H) x 504(V)  
 Active pixel: 659(H) x 494(V)  
 Video output pixels: 648(H) x 494(V) (Under non-interlace)  
 Scanning area: 4.88(H) x 3.66(V) mm (= Equivalent to 1/3" type CCD size)  
 Unit cell size: 7.4(H) x 7.4(V) μm (Square-grid array)  
 (2) Scanning lines: 525 lines  
 (3) TV system: Conforming to EIA

- (4) Interlace: 1/30s Non-interlace mode, 1/60s 2:1 Interlace mode  
 Switching via rear-panel DIP SW  
 Internal/External automatic switch-over: 4:3  
 VS 1.0V(p-p) / 75 Ω, DC coupled, 1 line  
 485 TV lines(H)  
 485 lines (350 TV lines(V))  
 Standard: 52dB(p-p)/rms (Initial factory setting)  
 Standard: 400 lx (F8)  
 Minimum 2 lx (F1.4) (GAIN MAX, Approx. 50 % video output)  
 FIX (Fixed) gain: Factory-shipped preset level  
 MANU (Manual) gain: Setting through GAIN VR  
 FIX / MANU switching via rear-panel DIP SW  
 Gamma = 1 (Fixed)  
 (12) Gamma correction  
 (13) White-clip level  
 (14) Power source: DC12V ±10 %  
 Ripple voltage: 50mV(p-p) or less  
 Approx. 1.3W  
 (15) Power consumption

[Internal sync spec]  
 (1) Base clock frequency: 12.273MHz (1CLK) ± 200ppm  
 (2) H sync frequency: 15.734kHz (1H = 780CLK)  
 (3) V sync frequency: 29.97Hz (Under non-interlace), 59.94Hz (Under 2:1 interlace)

[External sync spec]  
 (1) Ext. sync input signal: HD/VD  
 (2) Input level: 2~4V (p-p) 10kΩ  
 (3) Input impedance: 75Ω / High impedance (switching via rear-panel SW) (Initial factory setting: High)  
 (4) Interlace: 1/30s non-interlace or 1/60s 2:1 interlace  
 (5) Polarity: Negative  
 (6) Pulse width: HD: 6.4 ± 2 μs (LOW), VD: From 250 through 800 μs (LOW)  
 (7) Repeating frequency:  $f_H = 15.734\text{kHz} \pm 1\%$ ,  $f_V = f_H/262.5$  or  $f_H/525$   
 (8) Phase difference: HD/VD: 0 ± 5.0 μs, 1/2H ± 5.0 μs

[Shutter trigger spec]  
 Exposure-starting-cue signal in random trigger shutter mode  
 LOW level: 0~0.5V(p-p)  
 HIGH level: 4~5V(p-p)  
 High impedance (10kΩ)  
 Rising edge detection (Positive) / Falling edge detection (Negative) (Switching via rear-panel DIP SW)  
 (Initial factory setting: Rising edge)  
 (1) Input level: Minimum 4 μs, Maximum 1/4s

[Electronic shutter spec]  
 (1) Normal shutter: Shutter-speed setting via rear-panel SW (Initial: OFF)  
 Selection among 8 scales (= OFF, 1/100s, 1/250s, 1/500s, 1/1000s, 1/2000s, 1/4000s, 1/10000s)

(2) RTS (a) Operation mode

No.	Reset	Exposure	Sync
1		Rear SW (FLX mode)	Internal
2	Non-reset	Consecutive HD / Consecutive VD IN	Consecutive HD / Single VD IN
3		Consecutive HD / Single VD IN	
4	TRIG pulse width (PULSE mode)	Internal	Consecutive HD / Consecutive VD IN
5		Consecutive HD / Single VD IN	
6	V-reset	Rear SW (FLX mode)	Consecutive HD IN
7		Internal	
8	SYNC reset	Non-reset	Consecutive VD
9		Non-reset	
10	V reset	TRIG pulse width (PULSE mode)	Consecutive HD IN
11		Internal	

\* RTS shutter mode automatically switches over through TRIG IN  
 \*\* RTS disabled under electronic shutter OFF

(b) Multiple shutter  
 Multiple shutter via ext. trigger signal and ext. VD signal  
 \* Operation like No.3, 6 above

(3) Restart / Reset  
 Restart / reset available via ext. VD signal (Switching via rear panel DIP SW, Initial OFF)  
 Notes:  
 \* The exposure-time (shutter-speed) is determined by ext. VD interval.  
 \*\* Enabled when rear-panel DIP SW OFF.  
 \*\*\* Provide Consecutive HD.

[Mechanical spec]  
 (1) External dimension: 29 x 29 x 39.5(D)mm (Not including protrusion)  
 Refer to the attached external view drawing  
 Approximately 50g  
 C mount  
 Circuit GND ~ Chassis electrically conducted

[Ambient condition]  
 (1) Environment condition  
 Performance guaranteed: Temperature: From 0 through 40 °C, Humidity: From 30 through 90 % (No condensing)  
 Operation guaranteed: Temperature: From -5 through 50 °C, Humidity: From 10 through 90 % (No condensing)  
 Storage: Temperature: From -20 through 60 °C, Humidity: From 10 through 90 % (No condensing)  
 (2) EMC conditions (Electro-Magnetic Compatibility)  
 EMI (Electro-Magnetic Interference): EN50081-2 (Examination level EN55011-A) Conformity  
 EMS (Electro-Magnetic Susceptibility): EN61000-6-2 Conformity  
 \* Conformity of EMC conditions  
 About the conformity of the EMC standard of this machines, it has guaranteed in the conditions combined with the option part of 4<sup>th</sup> clause.  
 When used combining parts other than specification of our company, I ask you to have final EMC conformity checked of a visitor with a machine and the whole equipment.

[Connector pin assignment]  
 (1) Compatible connector  
 (2) Pin assignment

HR10A-10P-12S (Supplied by HIROSE ELEC.)

Pin No.	Signal (Standard)
1	DC12V GND
2	DC12V
3	VIDEO GND
4	VIDEO OUT
5	HD GND
6	HD IN
7	VD IN
8	TRIG GND
9	TRIG IN
10	GND
11	DC12V
12	VD GND

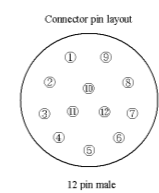

Picture Rear-camera connector (Rear-view)

\* Before connecting / disconnecting the connector, make sure the camera power is OFF.  
 \*\* For board connection, check compatibility.

[Switch setting]  
 (1) CCU rear-panel DIP SW

No.	Function	OFF	ON
1	E-shutter-speed (SHUT)	See shutter-speed table (Table 1)	
2		1/30s non-interlace	1/60s interlace
3			
4	Video output mode	1/30s non-interlace	1/60s interlace
5	Shutter mode (SMODE)	See shutter-mode table (Table 3)	
6			
7	Partial scan (PART)	See partial-scan table (Table 2)	
8			
9	TRIG polarity (TRIG)	Positive (Rising edge)	Negative (Falling edge)
10	RTS Exposure (EXP)	FIX mode	PULSE W mode

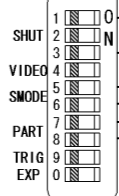

\* Initial factory setting: All OFF  
 \*\* Set No.9 OFF when TRIG IN OPEN.

(Table 1) Electronic shutter-speed

Shutter-speed	No.1	No.2	No.3
OFF	OFF	OFF	OFF
1/100s	ON	OFF	OFF
1/250s	OFF	ON	OFF
1/500s	ON	ON	OFF
1/1000s	OFF	OFF	ON
1/2000s	ON	OFF	ON
1/4000s	OFF	ON	ON
1/10000s	ON	ON	ON

\* Don't set Electronic shutter-speed in OFF under RTS mode.

(Table 2) Partial-scan

Partial scan	No.7	No.8
OFF	OFF	OFF
Not acceptable	ON	OFF
1/2 partial	OFF	ON
1/4 partial	ON	ON

(Table 3) Shutter-mode

Shutter mode	V reset	No.5	No.6	SYNC		
				Internal sync	Ext. sync	
Random trigger	SYNC reset	ON	OFF	Internal sync	HD IN	
	Non-reset	OFF	ON			
	Non-reset	ON	ON			
Random trigger	Non-reset (Multiple shutter)	OFF	OFF	Single VD	Ext. sync	
	Non-reset	ON	OFF	Consecutive VD		
	V-reset	OFF	ON	No. VD		
Restart / Reset				ON	ON	Single VD

\* Under normal shutter mode partial-scan, set No.5, 6 in OFF.  
 \*\* Under PULSE W mode, SYNC reset is disabled.

Function	SW	Selected Function
Ext. SYNC IN impedance (HD / VD)	HIGH	High impedance (Initial factory setting)
	75Ω	75Ω
GAIN selection (GAIN)	F	Factory-set GAIN
	M	Manual GAIN adjustable via GAIN potentiometer

## 7. TIMING CHART

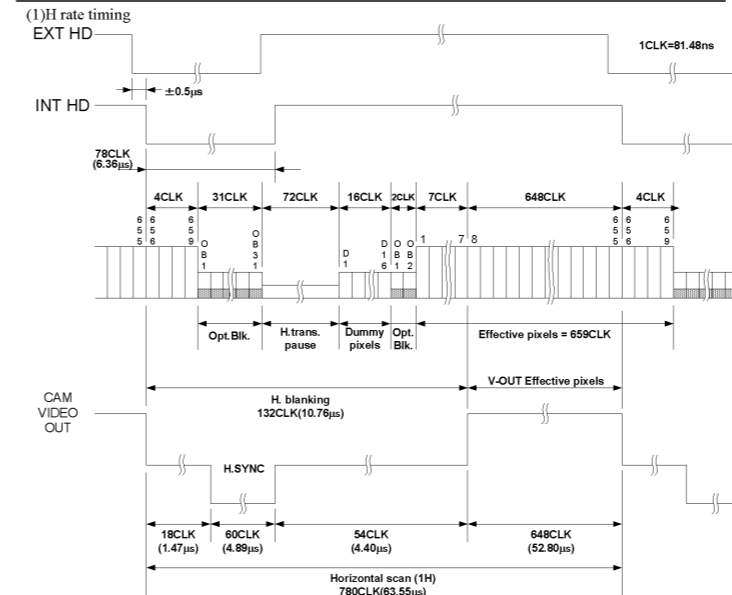

(2) 1/30s Non-interlace mode

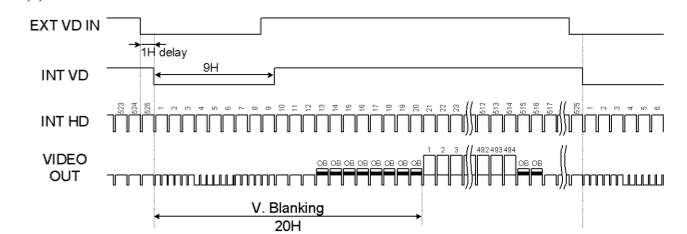

(3) 1/60s 2:1 Interlace mode

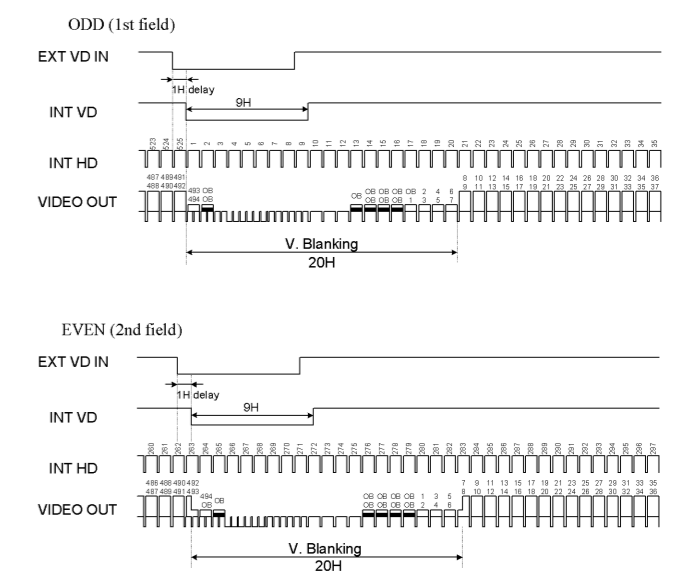

## 8. EXTERNAL VIEW DRAWING

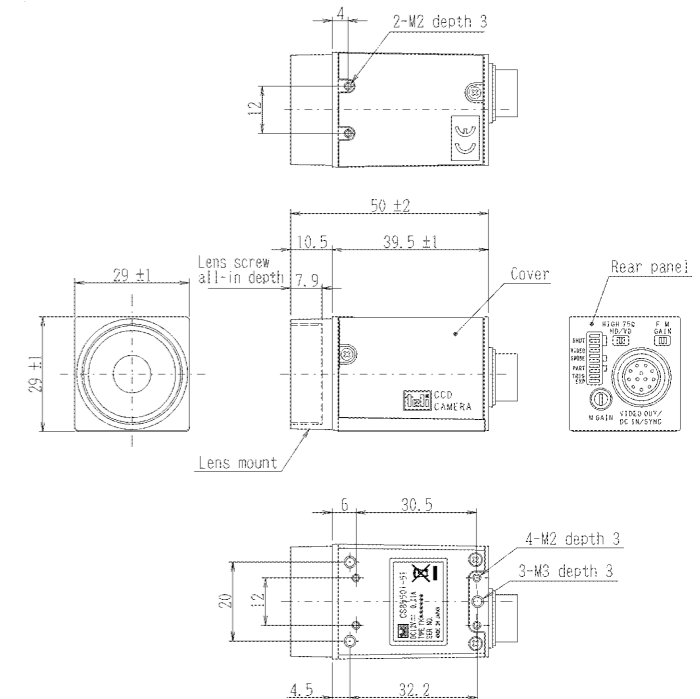

Specification  
 Material: Lens-mount, Rear panel: Aluminium die-cast  
 Cover: Anticorrosion aluminum alloy  
 Processing: Lens-mount, Rear panel: Cation coating  
 Cover: Leather satin coating