

# BG Series

# CMOS Camera

---

## Instruction Manual

Model  
Color Camera : BG205MC-CS / BG205MCF-CS

Thank you for purchasing our product.  
Before using this CMOS camera, Please read through this instruction manual carefully in order to use this product correctly and safely.  
After reading, keep this instruction manual handy so that you can refer to, whenever you need it.

# Toshiba Teli Corporation

Information contained in this document is subject to change without prior notice.  
Standard name might be trade mark of each company.

# Contents



Safety Precautions.....	1
General Handling .....	2
CASES FOR INDEMNITY (LIMITED WARRANTY) .....	4
RESTRICTION FOR USE .....	5
Notes on using this product.....	6
Installation .....	11
Specifications .....	12
Overview .....	12
Features.....	12
Configuration .....	14
Connection.....	15
Connector Pin Assignment.....	16
Outline Drawing .....	18
General Specifications .....	19
I/O Specification .....	21
Timing Specification .....	26
Typical Spectral Response.....	29
Operating Ambient Conditions .....	30
Functions.....	31
DeviceControl .....	33
Scalable .....	34
Decimation.....	36
Reverse .....	38
PixelFormat.....	39
TestImageSelector .....	40
AcquisitionControl.....	42
TriggerControl.....	44
ExposureControl .....	49
DigitalIOControl .....	51
TimerControl .....	53
EventControl .....	55
Gain .....	58
BalanceRatio .....	60
BalanceWhiteAuto .....	62
BlackLevel .....	63
Gamma .....	64
BlackLevelCorrection.....	65
LUTControl .....	66
TransportLayerControl.....	67
UserSetControl .....	71
ALCControl .....	73
Warranty rules.....	77
Repair.....	78

# Safety Precautions

Before using this product, read these safety precautions carefully. Important information is shown in this Instruction Manual to protect users from bodily injuries and property damages, and to enable them to use the product safely and correctly.

Please be sure to thoroughly understand the meanings of the following signs and symbols before reading the main text that follow, and observe the instructions given herein.

[Definition of Safety Signs]



Safety Signs	Description
 WARNING	Indicates a potentially hazardous situation that may result in death or serious injury (*1) in the event of improper handling.
 CAUTION	Indicates a potentially hazardous situation that may result in light to moderate injuries (*2) or only in property damage (*3) in the event of improper handling.

Notes \*1: "Serious injury" refers to cases of loss of eyesight, wounds, burns (high or low temperature), electric shock, broken bones, poisoning, etc., which leave after-effects or which require hospitalization or a long period of outpatient treatment of cure.

\*2: "Light to moderate injuries" refers to injuries, burns, electric shock etc. that do not require hospitalization or long-term treatment.

\*3: "Property damage" refers to cases of extensive damage involving damage to buildings, equipment, farm animals, pet animals and other belongings.

[Explanation of Safety Symbols]

Safety Symbols	Description
 PROHIBITED	This sign indicates <b>PROHIBITION</b> (Do not). The content of prohibition is shown by a picture or words beside the symbol.
 MANDATORY	This sign indicates <b>MANDATORY ACTION</b> (You are required to do). The content of action is shown by a picture or words beside the symbol.

# General Handing

---

## **WARNING**

---



Unplug

- **Stop operation immediately when any abnormality or defect occurs.**  
If abnormal conditions are present, such as smoke, a burning smell, ingress of water or foreign matter, or if the equipment is dropped or malfunctions, fire or electric shock may result.  
Be always sure to disconnect the power cable from the wall socket at once and contact your dealer.
- 



Do not get wet

- **Do not use the equipment in locations subject to water splashes.**  
Otherwise, fire or electric shock may result.
- 



Never pull apart

- **Do not disassemble, repair, or modify the equipment.**  
Otherwise, fire or electric shock may result.  
For internal repair, inspection, or cleaning, contact your sales representative.
- 



Avoid

- **Do not place anything on the equipment.**  
If metallic objects, liquid, or other foreign matter enters the equipment, fire or electric shock may result.
- 



Avoid

- **Do not install the equipment in an unstable or inclined location or locations subject to vibration or impact.**  
Otherwise, the equipment may topple over and cause personal injury.
- 



Do not touch

- **During an electrical storm, do not touch the power cable and the connection cable.**  
Otherwise, an electric shock may result.
- 



Instruction

- **Use the specified voltage.**  
Use of an unspecified voltage may result in fire or electric shock.
- 



Avoid

- **Do not be handled roughly, damaged, fabricated, bent forcefully, pulled, twisted, bundled, placed under heavy objects or heated the power cable and the connection cable.**  
Otherwise, fire or electric shock may result.
-

---

# CAUTION

---



Instruction

- **Observe the following when installing the equipment:**

- Do not cover the equipment with a cloth, etc.
- Do not place the equipment in a narrow location where heat is likely to accumulate. Otherwise, heat will accumulate inside the equipment, possibly resulting in a fire.



Avoid

- **Do not place the equipment in locations subject to high moisture, oil fumes, steam, or dust.**

Otherwise, fire or electric shock may result.



Avoid

- **Do not install the equipment in locations exposed to direct sunlight or humidity.**

Otherwise, the internal temperature of the equipment will rise, which may cause a fire.



Instruction

- **Use only specified the power cable and the connection cables.**

Otherwise, fire or electric shock may result.



Avoid

- **Do not give strong impact against the equipment.**

It may cause the trouble.



Instruction

- **When performing connection, turn off power.**

When connecting the power cable and the connection cable, turn off the equipment power.

Otherwise, fire or electric shock may result.



Avoid

- **Do not expose its camera head to any intensive light (such as direct sunlight).**

Otherwise, its inner image pickup device might get damaged.



Avoid

- **Avoid short-circuiting signal output.**

Otherwise, a malfunction may occur.



Avoid

- **Avoid giving a strong shock against the camera body.**

It might cause a breakdown or damage. If your camera is used in a system where its camera connector is subjected to strong repetitive shocks, its camera connector is possible to break down. If you intend to use your camera in such a situation, if possible, bundle and fix a camera cable in the place near the camera, and do not transmit a shock to the camera connector.



Instruction

- **Contact your sales representative to request periodic inspection and cleaning (every approx five years).**

Accumulation of dust inside the equipment may result in fire or electric shock. For inspection and cleaning costs, contact your sales representative.

# CASES FOR INDEMNITY (LIMITED WARRANTY)

We shall be exempted from taking responsibility and held harmless for damage or losses incurred by the user in the following cases.

- In the case damage or losses are caused by natural disasters, such as an earthquake and thunder, fire, or other acts of God, acts by a third party, deliberate or accidental misuse by the user, or use under extreme operating conditions.
- In the case of indirect, additional, consequential damages (loss of business interests, suspension of business activities) are incurred as result of malfunction or non-function of the equipment, we shall be exempted from responsibility for such damages.
- In the case damage or losses are caused by failure to observe the information contained in the instructions in this instruction manual and specifications.
- In the case damage or losses are caused by use contrary to the instructions in this instruction manual and specifications.
- In the case damage or losses are caused by malfunction or other problems resulting from unintended use of equipment or software etc. that are not specified.
- In the case damage or losses are caused by repair or modification conducted by the customer or any unauthorized third party (such as an unauthorized service representative).
- Expenses we bear on this product shall be limited to the individual price of the product.
- The item that is not described in specifications of this product is out of the guarantee.
- The case of damages or losses which are caused by incorrect connection of the cable is out of the guarantee.

# RESTRICTION FOR USE

- Should the equipment be used in the following conditions or environments, give consideration to safety measures and inform us of such usage:
  1. Use of the equipment in the conditions or environment contrary to those specified, or use outdoors.
  2. Use of the equipment in applications expected to cause potential hazard to people or property, which require special safety measures to be adopted.
  
- This product can be used under diverse operating conditions. Determination of applicability of equipment or devices concerned shall be determined after analysis or testing as necessary by the designer of such equipment or devices, or personnel related to the specifications. Such designer or personnel shall assure the performance and safety of the equipment or devices.
  
- This product is not designed or manufactured to be used for control of equipment directly concerned with human life (\*1) or equipment relating to maintenance of public services/functions involving factors of safety (\*2). Therefore, the product shall not be used for such applications.
  - (\*1): Equipment directly concerned with human life refers to.
    - Medical equipment such as life-support systems, equipment for operating theaters.
    - Exhaust control equipment for exhaust gases such as toxic fumes or smoke.
    - Equipment mandatory to be installed by various laws and regulations such as the Fire Act or Building Standard Law
    - Equipment related to the above
  - (\*2): Equipment relating to maintenance of public services/functions involving factors of safety refers to.
    - Traffic control systems for air transportation, railways, roads, or marine transportation
    - Equipment for nuclear power generation
    - Equipment related to the above

# Notes on using this product

- Handle carefully

Do not drop the equipment or allow it to be subject to strong impact or vibration, as such action may cause malfunctions. Further, do not damage the connection cable, since this may cause wire breakage.

- Environmental operating conditions

Do not use the product in locations where the ambient temperature or humidity exceeds the specifications.

Otherwise, image quality may be degraded or internal components may be adversely affected. In particular, do not use the product in areas exposed to direct sunlight. Moreover, during shooting under high temperatures, vertical stripes or white spots (noise) may be produced, depending on the subject or camera conditions (such as increased gain). However, such phenomena are not malfunctions.

- Check a combination with the lens

Depending on the lens and lighting you use, an image is reflected as a ghost in the imaging area. However, this is not because of a fault of the camera.

In addition, depending on the lens you use, the performance of the camera may not be brought out fully due to deterioration in resolution and brightness in the peripheral area, aberration and others.

Be sure to check a combination with the camera by using the lens and lightning you actually use.

When installing a lens in the camera, make sure carefully that it is not tilted.

In addition, use a mounting screw free from defects and dirt. Otherwise, the camera may be unable to be removed.

Install a next lens; its dimension of protrusion from bottom of the screw is equal to or less than 4.9 mm. If a lens does not stand to this condition, it might not be installed to this camera.

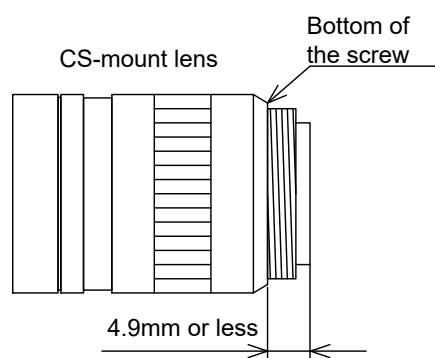

- Mounting to pedestal

When mounting this product to a pedestal, make sure carefully that lens doesn't touch with the pedestal.



- Do not expose the camera's image-pickup-plane to sunlight or other intense light directly  
Its inner CMOS sensor might be damaged.
  
- Occurrence of moiré  
If you shoot thin stripe patterns, moiré patterns (interference fringes) may appear. This is not a malfunction.
  
- Occurrence of noise on the screen  
If an intense magnetic or electromagnetic field is generated near the camera or connection cable, noise may be generated on the screen. If this occurs, move the camera or the cable.
  
- Handling of the protective cap  
If the camera is not in use, attach the lens cap to the camera to protect the image pickup surface.
  
- If the equipment is not to be used for a long duration  
Turn off power to the camera for safety.
  
- Maintenance  
Turn off power to the equipment and wipe it with a dry cloth.  
If it becomes severely contaminated, gently wipe the affected areas with a soft cloth dampened with diluted neutral detergent. Never use alcohol, benzene, thinner, or other chemicals because such chemicals may damage or discolor the paint and indications.  
If the image pickup surface becomes dusty, contaminated, or scratched, consult your sales representative.

- Disposal

When disposing of the camera, it may be necessary to disassemble it into separate parts, in accordance with the laws and regulations of your country and/or municipality concerning environmental contamination.

This product is marked this symbol to subject to EU Waste Electrical & Electronic Equipment (WEEE) directive.

**Following information is only for EU-member states:**

The use of the symbol indicates that this product may not be treated as household waste. By ensuring this product is disposed of correctly, you will help prevent potential negative consequences for the environment and human health, which could otherwise be caused by inappropriate waste handling of this product. For more detailed information about the take-back and recycling of this product, please contact your supplier where you purchased the product.



	“This symbol is applicable for EU member states only”
--	---

This equipment has been tested and found to comply with the limits for a class A digital device, pursuant to Part 15 of the FCC Rules.

These limits are designed to provide reasonable protection against harmful interference when the equipment is operated in a commercial environment.

This equipment generates, uses, and can radiate radio frequency energy and, if not installed and used in accordance with the instruction manual, may cause harmful interference to radio communication.

Operation of this equipment in a residential area is likely to cause harmful interference in which case the user will be require to correct the interference at his own expense.

## [Phenomena specific to CMOS sensor]

- **Defective pixels**

A CMOS image sensor is composed of photo sensor pixels in a square grid array. Due to the characteristics of CMOS image sensors, over- or under-driving of the pixels results in temporary white or black areas (as if these are noises) appearing on the screen. This phenomenon, which is not a defect is exacerbated under higher temperatures and long exposure time.

- **Image shading**

The brightness of the upper part of the screen may be different from that of the lower part. Note that this is a characteristic of a CMOS image sensor and is not a fault.



中华人民共和国  
环保使用期限

环保使用期限标识，是根据电子信息产品污染控制管理办法以及，电子信息产品污染控制标识要求(SJ/T11364-2014)、电子信息产品环保使用期限通则，制定的适用于中国境内销售的电子信息产品的标识。

电子信息产品只要按照安全及使用说明内容，正常使用情况下，从生产月期算起，在此期限内，产品中含有的有毒有害物质不致发生外泄或突变，不致对环境造成严重污染或对其人身、财产造成严重损害。

产品正常使用后，要废弃在环保使用年限内或者刚到年限的产品时，请根据国家标准采取适当的方法进行处置。

另外，此期限不同于质量/功能的保证期限。

The Mark and Information are applicable for People's Republic of China only.

<产品中有毒有害物质或元素的名称及含量>

部件名称	有毒有害物质或元素					
	铅 (Pb)	汞 (Hg)	镉 (Cd)	六价铬 (Cr(VI))	多溴联苯 (PBB)	多溴二苯醚 (PBDE)
相机本体	×	○	○	○	○	○

「本表格依据SJ/T 11364的规定编制」

○：表示该有毒有害物质在该部件所有均质材料中的含量均在电子信息产品中有毒有害物质的限量要求标准规定的限量要求(GB/T26572)以下

×：表示该有毒有害物质至少在该部件的某一均质材料中的含量超出电子信息产品中有毒有害物质的限量要求标准规定的限量要求(GB/T26572)

This information is applicable for People's Republic of China only.

リサイクルに関する情報（包装物）

有关再利用的信息(包装物)

Information on recycling of wrapping composition

箱 / 箱子 / Box

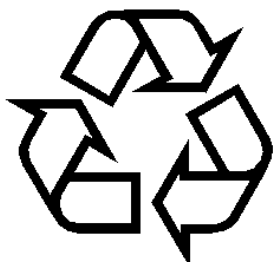

ペーパーボード  
纸板  
Paper board

内部緩衝材料・袋

内部缓冲材料・袋

Internal buffer materials • Bag



PE-LD

# Installation

Before using this product, you shall install application software to display image and control registers of camera, and IP configuration tool for network setting.

You can download the SDK for our GigE camera products (TeliCamSDK) from the Service & Support section of our website.

User registration is necessary to use downloading service. Please make a user registration, or contact your dealer / distributor.

- TOSHIBA TELI CORPORATION Top Page  
<http://www.toshiba-teli.co.jp/en/>
- Service & Support  
<https://www.toshiba-teli.co.jp/cgi/ss/en/service.cgi>

Please refer to the TeliCamSDK startup guide, about Operation environment, Installation, and Setup.

# Specifications

## Overview

This BG series is an integrated-(one-body)-type monochrome and color camera that adopts a global shutter CMOS sensor. BG205MC-CS (2M 2/3 type, color) and BG205MCF-CS (2M 2/3 type, color, IR-cut).

For video output, the Gigabit Ethernet® interface standard "IEEE802.3ab" is adopted for high transfer rate, and it is easy to integrate into industrial equipment.

\* Ethernet® is a registered trademark of XEROX Corporation.

## Features

- High frame rate and high resolution  
Supported high frame rate, BG205MC(F)-CS 50fps.
- Global shutter  
As it employs a global electronic shutter similar to a CCD image sensor, clear images of even fast-moving object are obtainable with less blur.
- Gigabit Ethernet interface (Power over Ethernet)  
Video output and camera control are performed via the Gigabit Ethernet standard IEEE802.3ab interface. Data transfer is up to 1Gbps (Maximum) that enables to output uncompressed video data at high frame rate. By complying with IEEE802.3af Power over Ethernet (PoE), the power is supplied over single cable.
- GigEVision Ver 1.2 conformity  
This product is based on GigEVision Camera Interface Standard for Machine Vision Ver 1.2.
- GenICam Ver 2.3 conformity  
This product is based on GenICam Generic Interface for Cameras Ver 2.3.

- Random Trigger Shutter

The Random Trigger Shutter function provides images in any timing by input of an external trigger signal. Trigger control from PC is available as well.

- Scalable

Selectable video output area. This mode achieves higher frame rate by reducing vertical output area. And reduces occupied data rate of Gigabit Ethernet by reducing horizontal output area.

- Decimation mode

Camera reads all effective areas at high speed by skipping lines.

- Color processing

This BG series have built in color processing. Color processing features like white balance are available in Bayer output mode.

- IR-cut filter

Build-in IR-cut filter models are optional for color models.

The character [F] of the model name indicates the built-in IR-cut filter model. (e.g. BG205MCF-CS)

\* The character [F] is not shown in the common part of specifications.

- Compact and lightweight

This camera is compact and lightweight; it is easy to integrate into industrial equipment.

- EU RoHS & Chinese RoHS

# Configuration

The system configuration of this camera series is as follows;

This camera does not include any accessories. Please prepare other equipments separately.

- Camera: This product. (BG series)
- Camera mounting kit (\*1)  
CPT8600, CPTBUBG: To fix a camera to a tripod; attach this to the bottom of the camera.
- LAN Cable (\*2): This cable is used to connect the camera to host equipment. Ethernet packets (stream and control) are transmitted via this cable. Please use a LAN cable that supports 1000BASE-T (Cat 5e or over). This product is able to connect a LAN cable that is equipped with screw lock mechanism. Please use it as needed.
- Network Interface Card (NIC) (\*2): This is the interface card to connect to the camera. Usually this card is installed to expansion slot of host equipment such as PC etc. Please use 1000BASE-T NIC, supporting Jumbo Frame is recommended.
- PoE Switching HUB etc. (\*2): Use these equipments when you supply power to the camera from PoE. Please use 1000BASE-T equipments, supporting Jumbo Frame is recommended.

\*1: Optional part. Contact your dealer / distributor for details of option units.

\*2: Commercial items.



# Connection

- In the case of supply DC+12V to the camera.

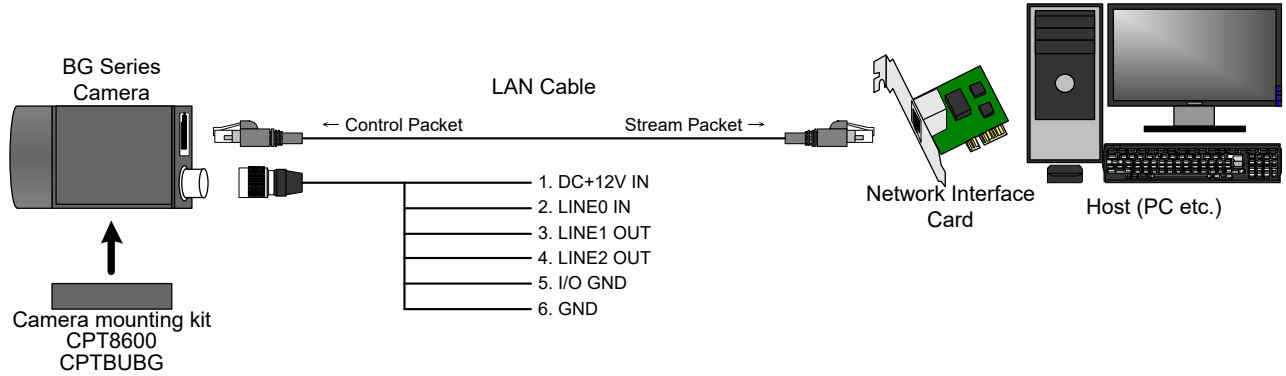

- In the case of supply PoE power to the camera.

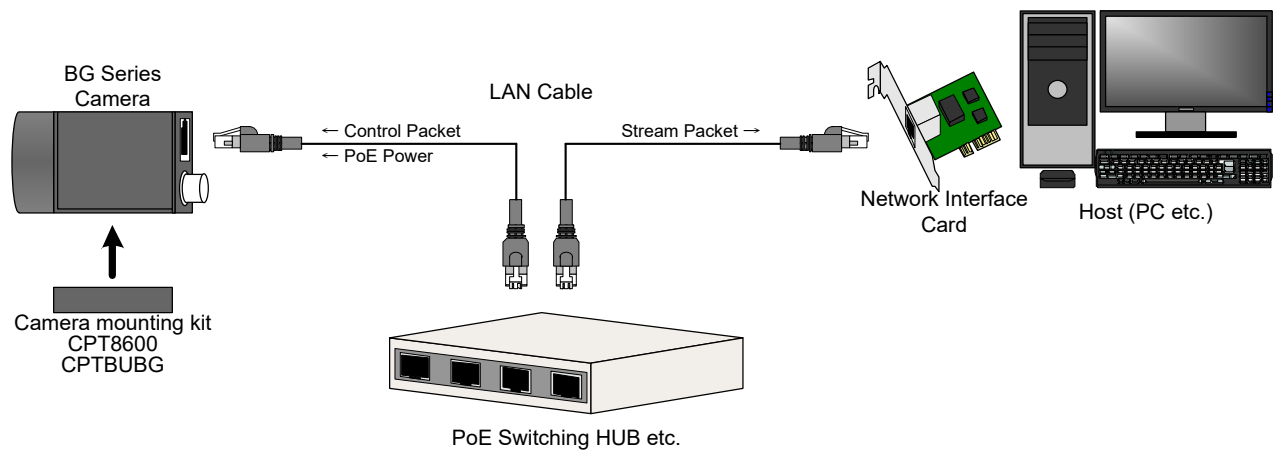

## Connection

### Notes on Connection:

- Please confirm the power supply of the camera off when plugging in or pulling out the I/O Connector. It causes the breakdown.
- If your camera is used in a system where its connectors are subjected to strong repetitive shocks, its connectors are possible to break down. If you use your camera in such a situation, use an LAN cable with a lock screw, and secure the camera cable as close as possible to the camera body for avoid physical shock to the camera connector.
- About Camera cable: In the case that electric-wire is long or thin, input voltage may not satisfy specifications of the power supply voltage of the camera by voltage drop. Please confirm it before use.
- Lost packets may occur by an electrical characteristic of the transmission line of using Ethernet devices (LAN cable, Network Interface Card, Switching HUB).

# Connector Pin Assignment

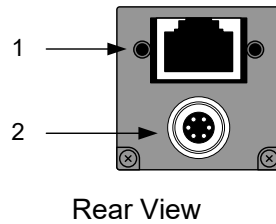

## 1. Gigabit Ethernet Interface Connector

RJ-45 Jack

Pin No.	I/O	Signal	Function
1	I/O	BI_DA+ / VDC+	Bidirectional Data A (+) / Power (+)
2	I/O	BI_DA- / VDC+	Bidirectional Data A (-) / Power (+)
3	I/O	BI_DB+ / VDC-	Bidirectional Data B (+) / Power (-)
4	I/O	BI_DC+ / VDC+	Bidirectional Data C (+) / Power (+)
5	I/O	BI_DC- / VDC+	Bidirectional Data C (-) / Power (+)
6	I/O	BI_DB- / VDC-	Bidirectional Data B (-) / Power (-)
7	I/O	BI_DD+ / VDC-	Bidirectional Data D (+) / Power (-)
8	I/O	BI_DD- / VDC-	Bidirectional Data D (-) / Power (-)

## 2. I/O Connector

Connector (Camera side) HR10A-7R-6PB(73) (HIROSE ELECTRIC CO., LTD.) or equivalency product

Plug (Cable side) HR10A-7P-6S(73) (HIROSE ELECTRIC CO., LTD.) or equivalency product

\* This camera cable is not an accessory of this product.

Connector view from mating face

Camera side

Cable side

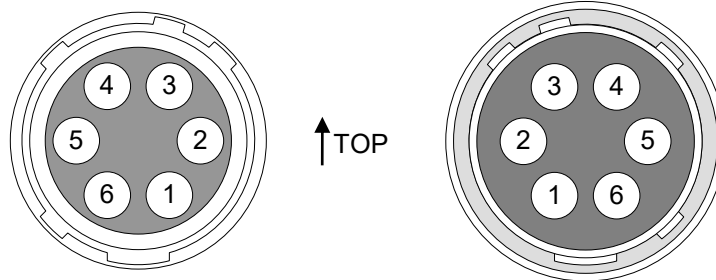

Pin No.	I/O	Signal	Function
1	I	+12V	Power
2	I	Line 0	External Trigger Input
3	O	Line 1	GPIO_0 Output (LVTTTL)
4	O	Line 2	GPIO_1 Output (Open Collector)
5	-	I/O GND	I/O_Ground
6	-	GND	Ground

**Notes on Power Supply:**

This camera has two ways of power supply,

- Supply from LAN cable (PoE)
- Supply from camera cable (DC+12V  $\pm$ 10%)

If both PoE and DC+12V are connected, power is supplied from PoE.

# Outline Drawing

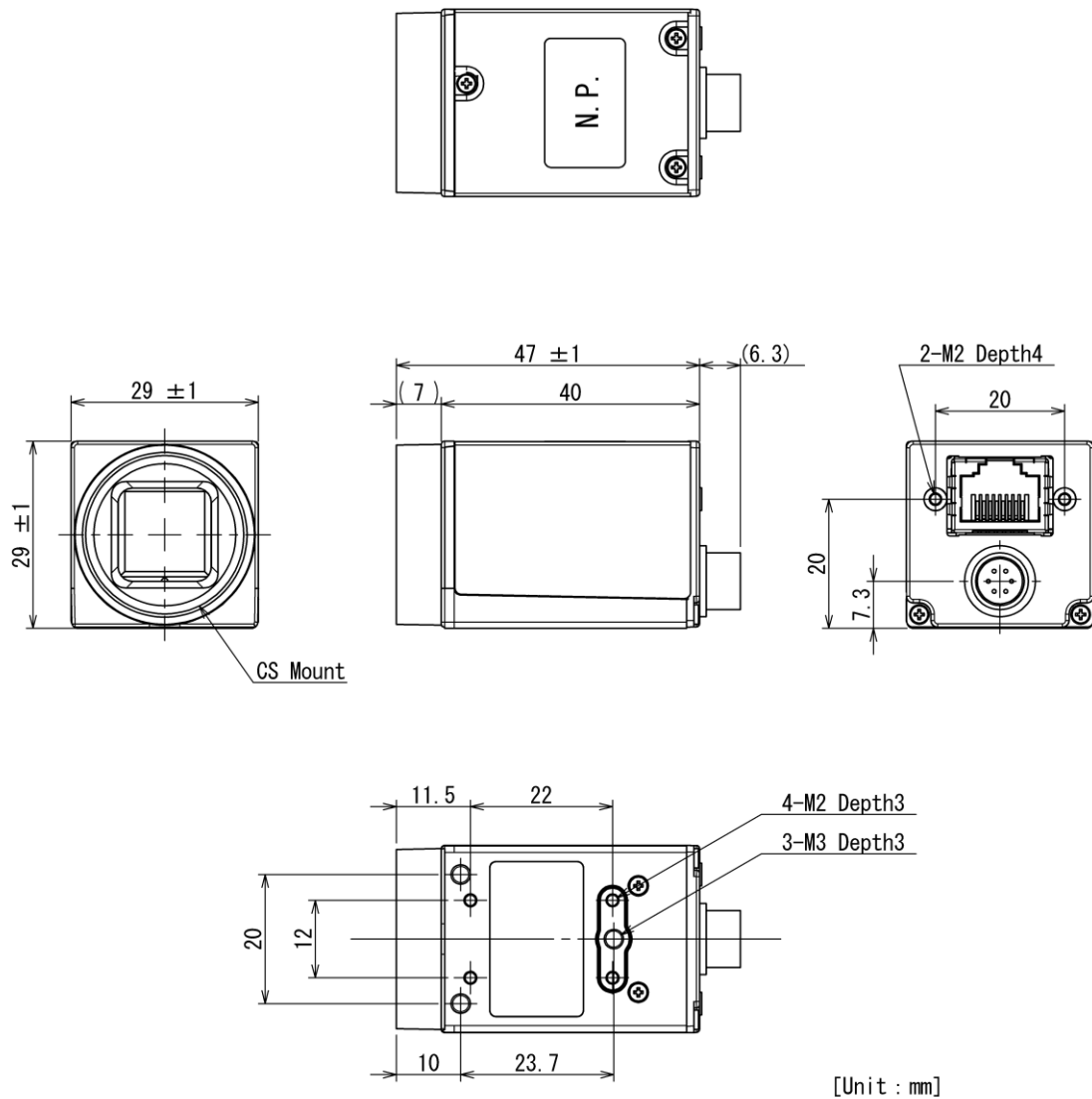

## Specification

### Material

Lens mount, Rear panel : Aluminum die cast

Cover : Anticorrosion aluminum alloy

### Processing

Lens mount, Cover, Rear panel: Cation coating(black)

Outline Drawing

# General Specifications

Specifications

Model Name	BG205MC-CS	BG205MCF-CS
IR-cut filter	None	Built-in
Imager	CMOS image sensor	
Number of effective pixels (H) × (V)	2048 × 1088	
Optical Size	2/3 type	
Scanning area (H) × (V)[mm]	11.26 × 5.98	
Pixel size (H) × (V)[μm]	5.5 × 5.5	
Scan method	Progressive	
Electronic shutter method	Global shutter	
Aspect ratio	2: 1	
Sensitivity	2300lx (F11, 1/50s)	2900lx (F11, 1/50s)
Minimum illuminance (*1)	3lx	4lx
Power supply	PoE (Power over Ethernet IEEE802.3af conformity) DC12V ± 10% (ripple 100 mV(p-p) or less)	
Power consumption (*2)	PoE	2.9 W Max
	DC12V	2.5 W Max
Interface system	Gigabit Ethernet IEEE802.3ab (1000BASE-T) conformity	
Transmission speed	1Gbps (Maximum)	
Protocol	GigEVision Camera Interface Standard for Machine Vision Ver 1.2	
Conformity LAN Cable	Twist pair (Category 5e or over)	
LAN Cable length	To 100m (at the Unshielded Twist Pair (UTP) cable using)	
Image format	Bayer 8 bit	
Number of Video out pixels (H) × (V)	2048 × 1088	
Maximum Frame rate (*2)	50 fps	
Dimensions	29mm(W) × 29mm(H) × 40mm(D) (Not including protrusion)	
Mass	Approximately 50 g	Approximately 51 g
Lens mount	CS-mount	
Flange back	12.5mm	
Camera body grounding: insulation status	No conductive between circuit GND and camera body	

\*1 F1.4, Gain: Maximum (+18dB), video level: 50%

\*2 at the all pixel readout

**Notes on combination of CS-mount lens:**

- Depending on the lens you use, the performance of the camera may not be brought out fully due to the deterioration in resolution and brightness in the peripheral area, occurrence of a ghost, aberration and others. When you check the combination between the lens and camera, be sure to use the lens you actually use.
- In addition, use a mounting screw free from defects and dirt. Otherwise, the camera may be unable to be removed.
- As for the CS-mount lens used combining this camera, the projection distance from bottom of the screw should use 4.9mm or less.

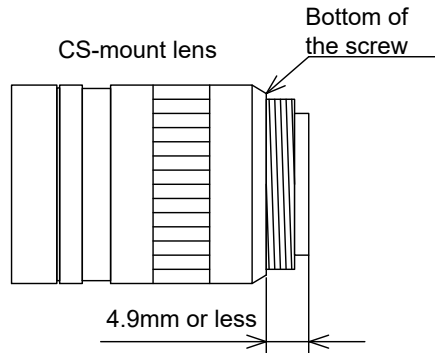

# I/O Specification

- Signal Specification

- Trigger Input

Input Circuit	: Opto coupler input
Input Level	: Low 0 ~ 0.5V, High 3.3 ~ 24.0V
Input Current	: 5 ~ 15mA
Polarity	: Positive / Negative bipolar (initial factory setting: Negative)
Pulse Width	: Minimum 200 $\mu$ s

**Notes of external trigger signal:**

Depending on cable length, cable kinds and input current of trigger input line, Random Trigger Shutter operation may not satisfy timing specification or camera

- GPIO Output

Output Circuit	: LINE1 LVTTTL output LINE2 Opto coupler output
Output Level	: LINE1 LVTTTL LINE2 Open collector
Maximum Current:	LINE1 +/-24mA (drive current) LINE2 50mA (input current)
Polarity	: Positive / Negative bipolar (initial factory setting: Negative)
Signal Source	: VD TIMER0 ACTIVE EXPOSURE ACTIVE FRAME ACTIVE FRAME TRANSFER FRAME TRIGGER WAIT

- Circuit diagram
  - Trigger Input

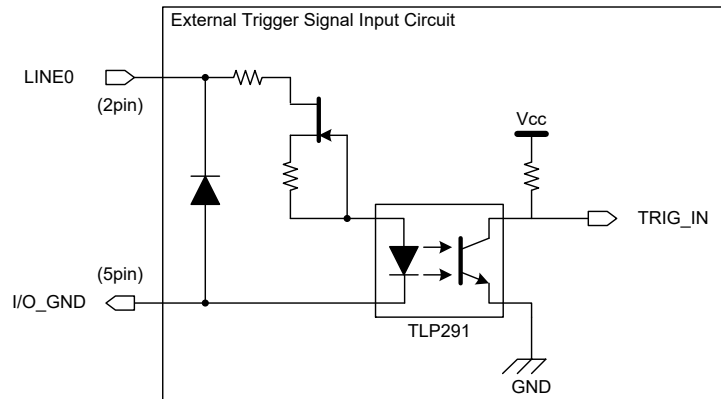

- GPIO Output

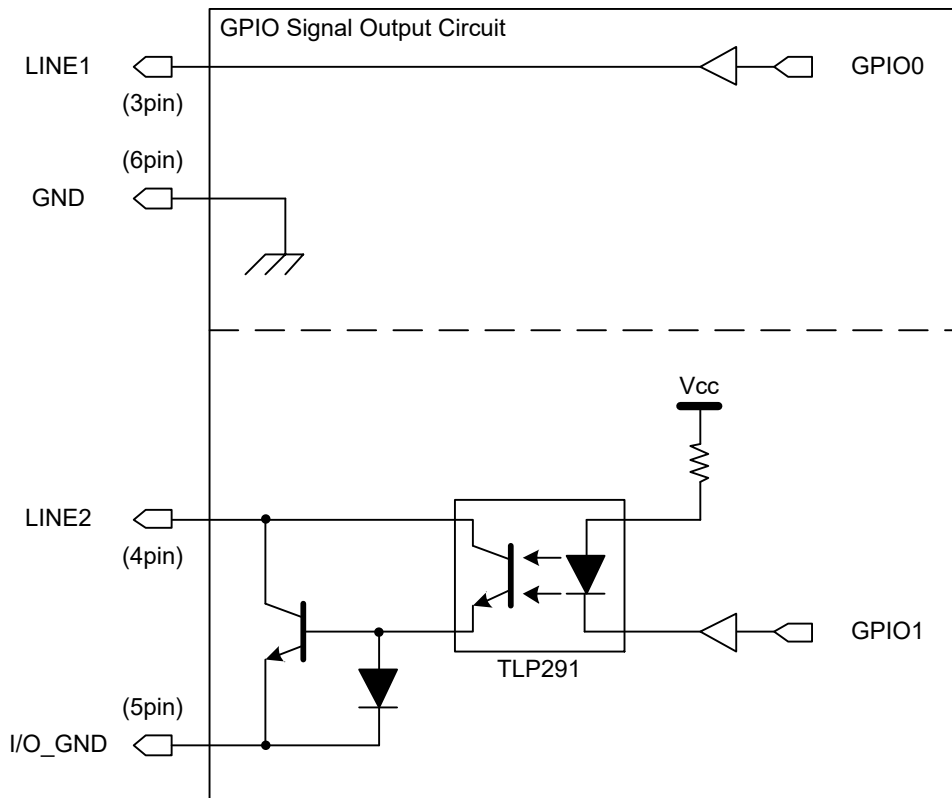

Circuit diagram



● I/O Timing

The received external trigger signal delays by internal circuit.

And LINE2 output delays from LINE1 output by the difference of internal circuit.

- Trigger Input

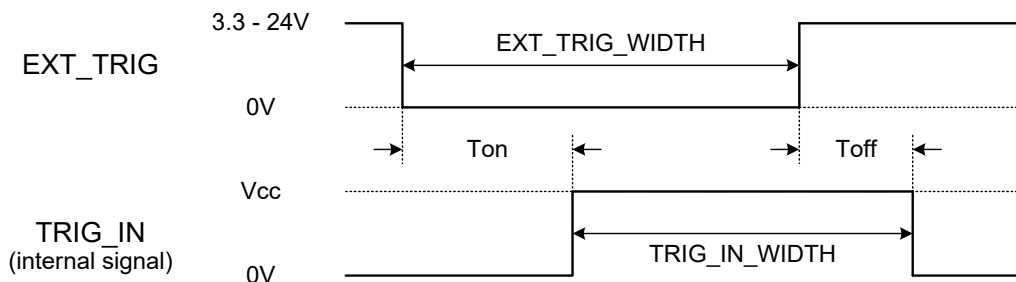

(a) Negative

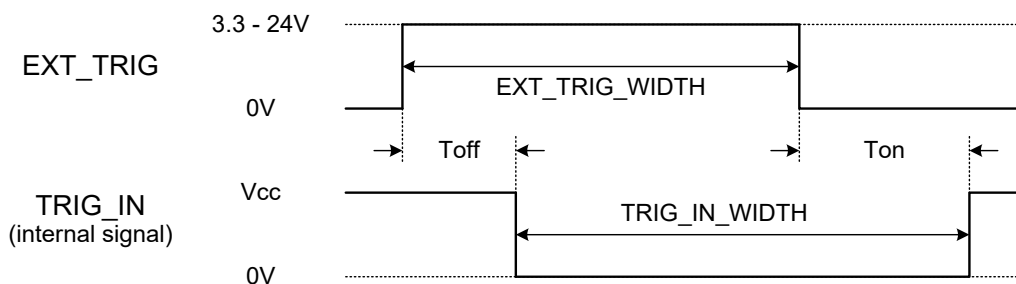

(b) Positive

Trigger Signal Input Delay

EXT\_TRIG\_WIDTH: The pulse width of the external trigger input (more than 200µs).

Toff: The delay time of falling edge.

Ton: The delay time of rising edge.

TRIG\_IN\_WIDTH: The pulse width of the trigger signal which is received inside of the camera.

Negative trigger:  $TRIG\_IN\_WIDTH = EXT\_TRIG\_WIDTH - (Ton - Toff)$

Positive trigger:  $TRIG\_IN\_WIDTH = EXT\_TRIG\_WIDTH + (Ton - Toff)$

Trigger input delay

Trigger amplitude	Toff [µs]	Ton [µs]
+3.3V	2.92	26.2
+12V	2.12	31.2
+24V	2.12	31.2

\* Toff and Ton are typical value.

\* These values are changed in operating environment.

- GPIO Output

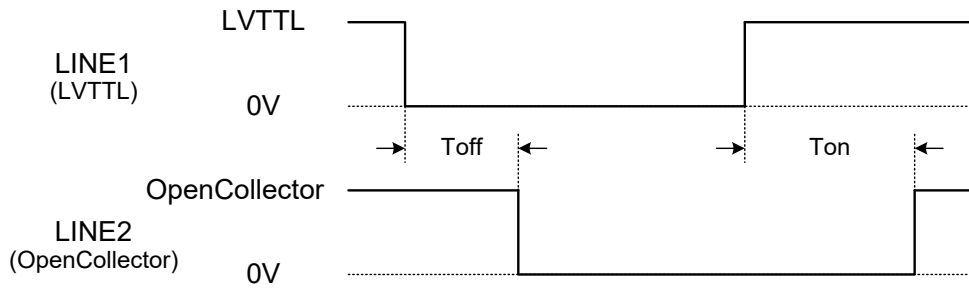

(a) ActiveLow

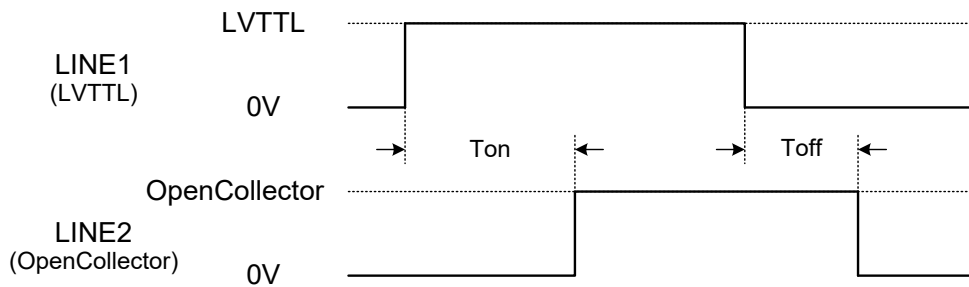

(b) ActiveHigh

GPIO Signal Output Delay

Toff: LINE1~LINE2 falling delay time

Ton: LINE1~LINE2 rising delay time

GPIO signals output delay

Pull-up amplitude	Toff [ $\mu$ s]	Ton [ $\mu$ s]
+3.3V	3	53.2
+12V	4	78.4
+24V	5	94.4

\* Toff and Ton are typical value.

\* These values are changed in operating environment.

● Anti-chattering process for Trigger input

In the characteristic of the open collector circuit, the signal is skewed. As a result, an unstable logic value occurs. To filter out an unstable logic value, this camera has the anti-chattering circuit. Therefore, Random Trigger Shutter operates only in the stable logic value.

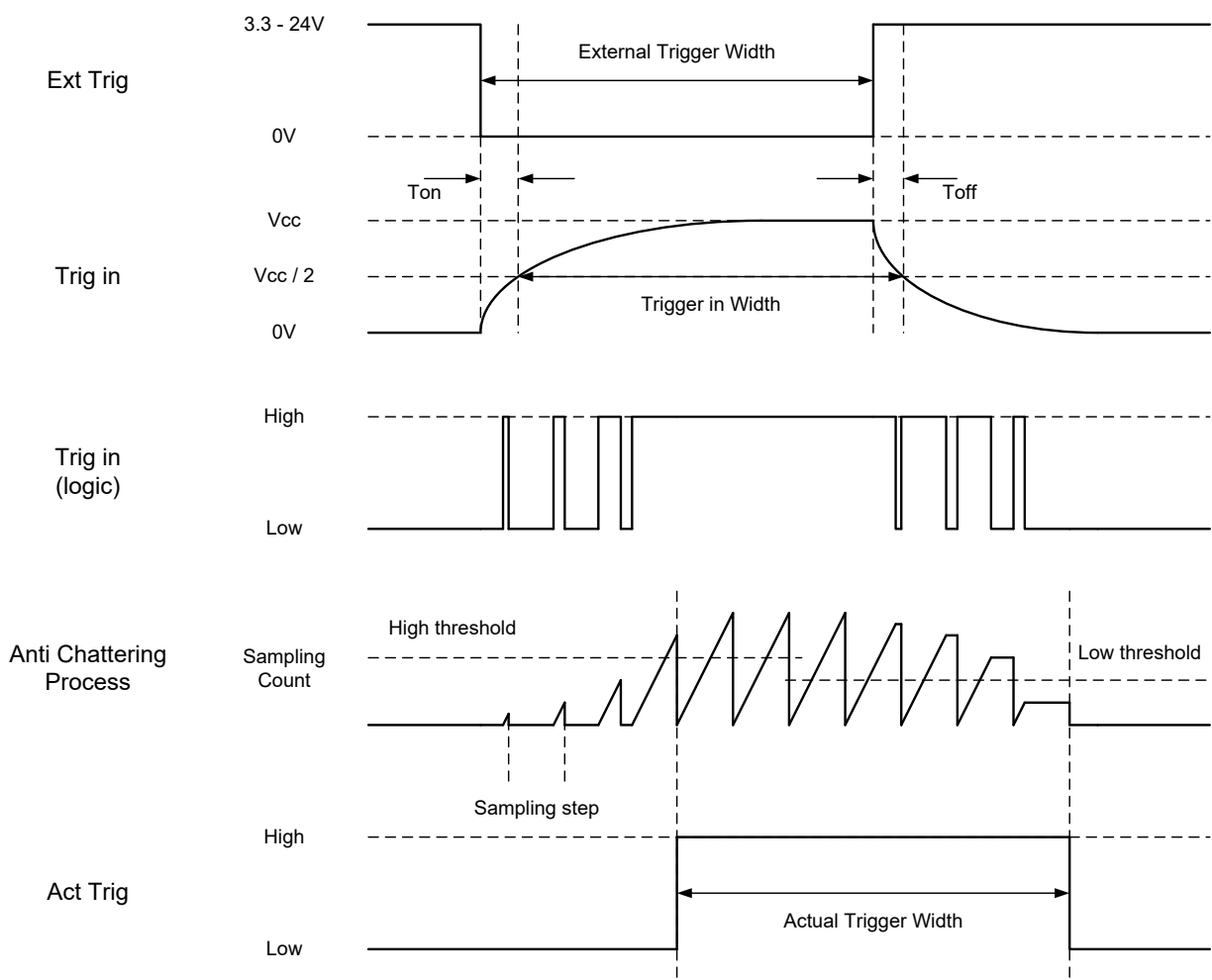
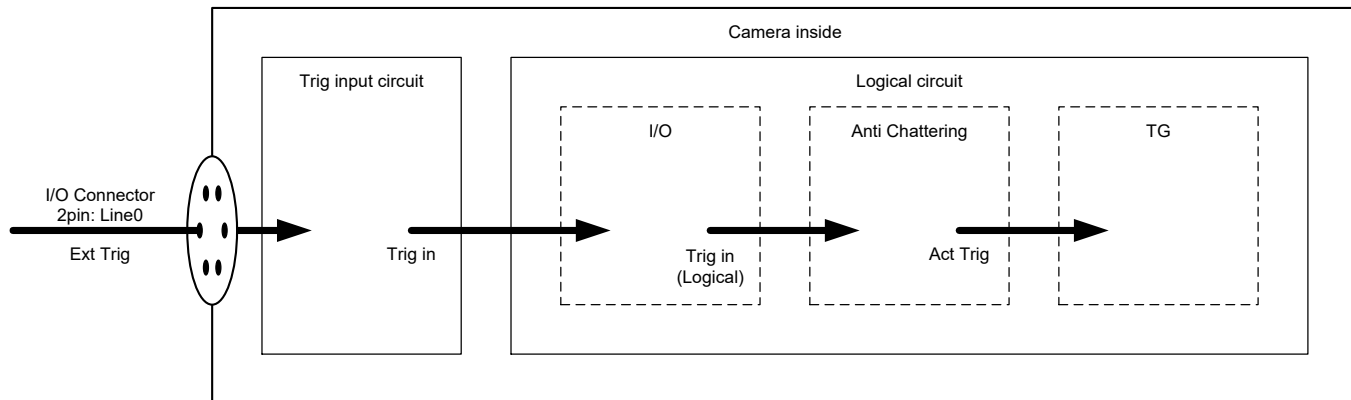

Anti-chattering process

# Timing Specification

Image data outputs of this camera series are transferred with the UDP protocol of Gigabit Ethernet. Timing numerical value below is prescribed by absolute prerequisite that BG series use transmission band without restriction of other node. When there is a node transferring with BG series concerned, it is not same the numerical value prescribed below.

- Image Stream Output (normal shutter)

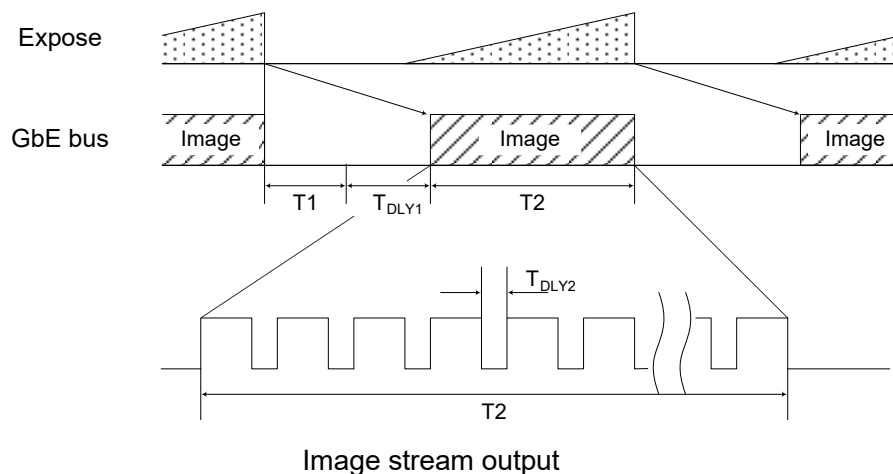

Image stream output

Model	T1 [ms]	T2 [ms]	Default Framerate [ms]
BG205MC-CS	see following formula.	same as Frame Rate.	20.0

$T_{DLY1}$ : GVSP\_BLOCK\_START\_DELAY

$T_{DLY2}$ : SCPD(Stream Channel Packet Delay)

$$* T_1 = ( T_2 / ( \frac{\text{PayloadSize}}{\text{SCPS} - 36} ) ) \times 3 ,$$

B/W model:  $T_1 = 100\mu\text{s}$  or longer, Color model:  $T_1 = 250\mu\text{s}$  or longer

PayloadSize is total bytes of single frame.

The formula applies when SCPS (Stream Channel Packet Size) is 1500 byte / packet.

( $T_1$  varies depending on the value of SCPS)

• Random Trigger Shutter Operation

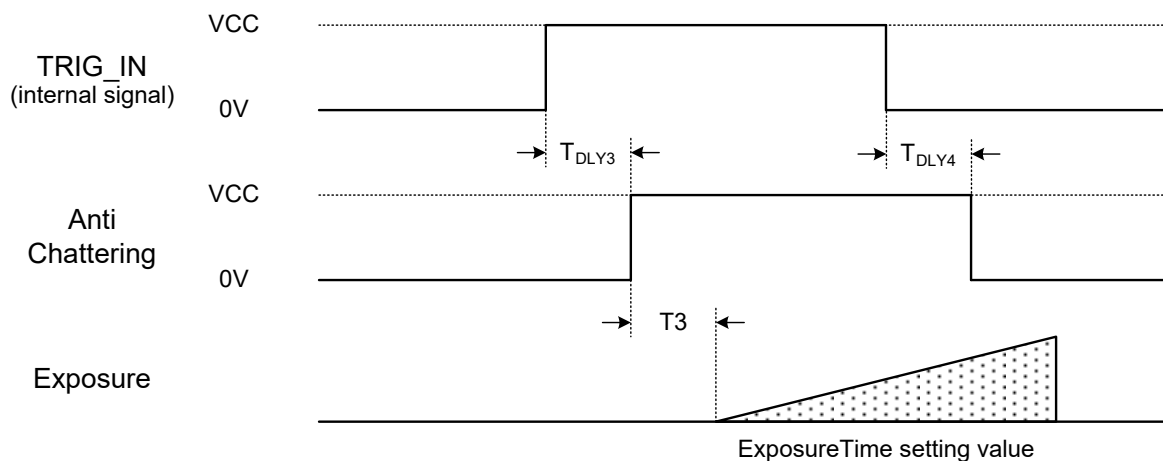

Timed mode / FrameBurst(Bulk) mode (Image format: Mono8bit, all pixel readout)

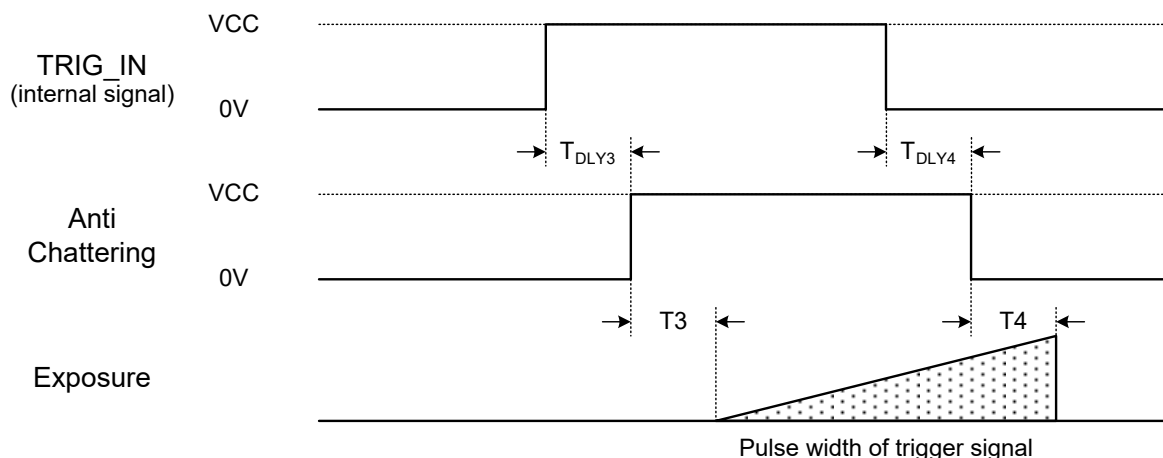

TriggerWidth mode (Image format: Mono8bit, all pixel readout)

Random Trigger Shutter operation

Random Trigger Shutter operation

Model	T3 [ $\mu$ s]	T4 [ $\mu$ s]
BG205MC-CS	0.26	0.26

\* TDLY3, TDLY4: TriggerSamplingPeriod (typical value)

Max TriggerSamplingPeriod x 1.625[ $\mu$ s], Min TriggerSamplingPeriod x 0.625[ $\mu$ s]

\* T3 and T4 are typical value.

**Notes of random trigger shutter mode:**

- In the period when FRAME\_TRIGGER\_WAIT (GPIO signal) is inactive, user must not input external trigger signal to this camera.
- When the interval of the input trigger signal is extremely short, or when the trigger signal is noisy, there is a possibility of causing the malfunction. In this case, please input a proper trigger signal.

# Typical Spectral Response

\* The lens characteristics and light source characteristics is not reflected in table.

< BG205MC-CS >

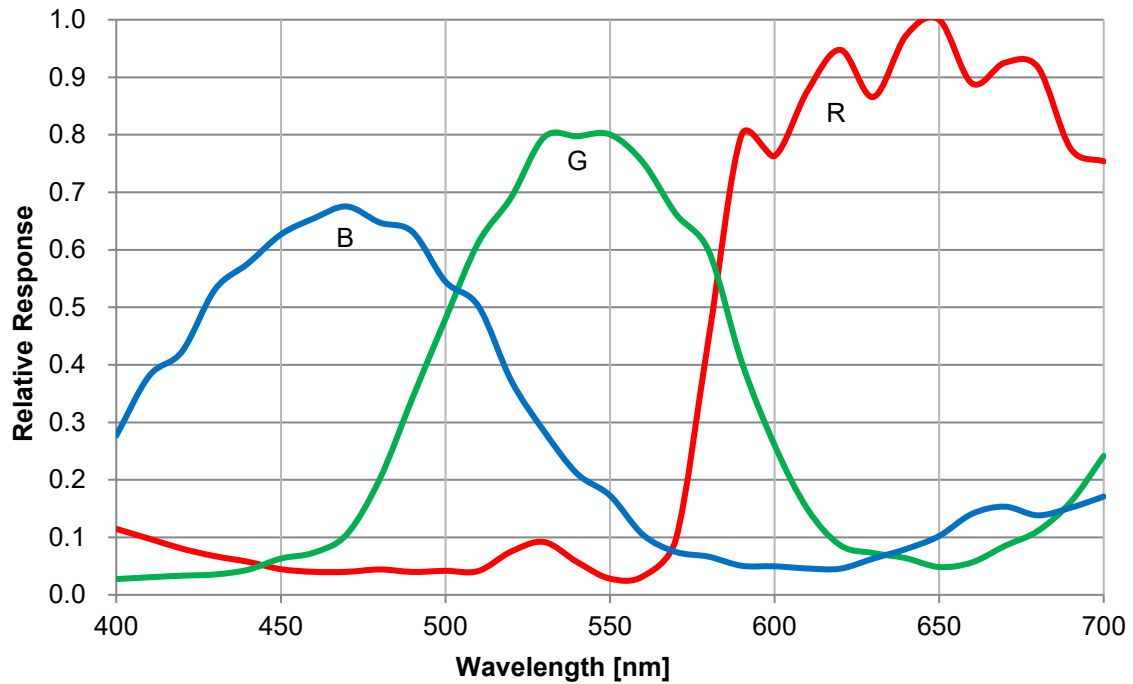

< BG205MCF-CS >

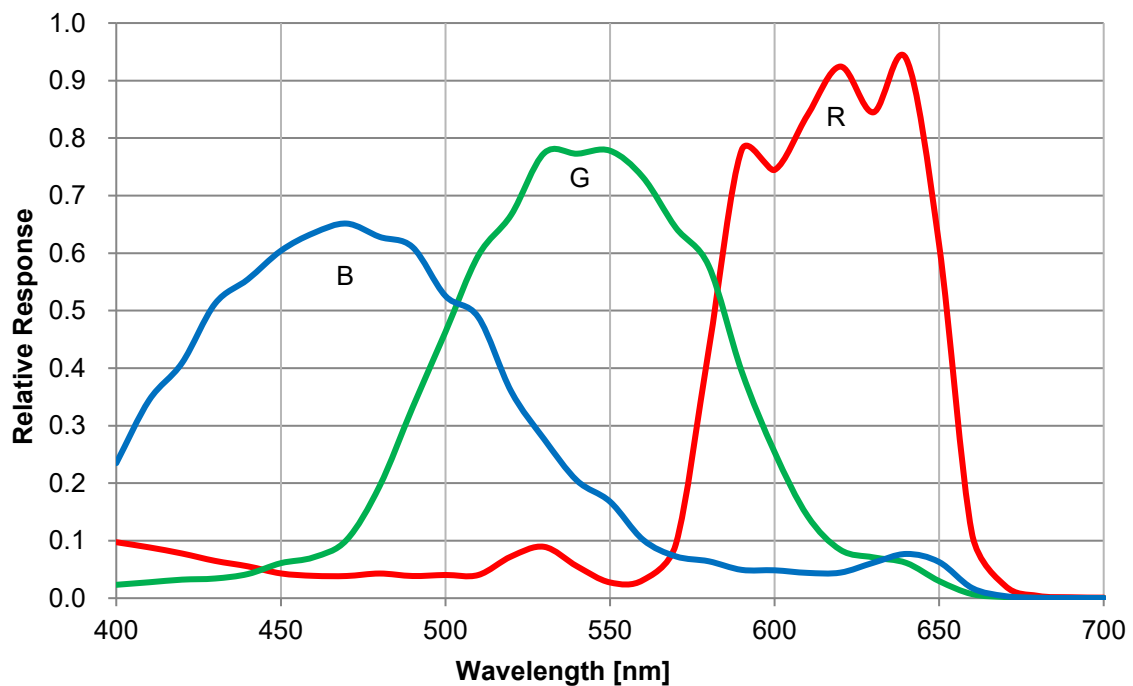

# Operating Ambient Conditions

- Ambient conditions

- Operating Assurance

Temperature: 0°C ~ 40°C, Camera housing temperature: less than 50°C  
Humidity: 10% ~ 90% (no condensation)

- Storage Assurance

Temperature: -20°C ~ 60°C  
Humidity: 90% or less (no condensation)

## **Notes on Heat Radiation:**

The top surface temperature of camera housing must be kept less than 50 °C in principle.

However, about the upper limit of top surface temperature of camera housing and the allowed ambient temperature of each model, please refer to the "Thermal design manual" on our HP.

- EMC Conditions

- EMI (Electro-Magnetic Interference): EN61000-6-4  
FCC Part 15 Subpart B Class A
- EMS (Electro-Magnetic Susceptibility): EN61000-6-2

## **Notes on Conformity of the EMC:**

The adaptability of the safety standard of this camera is assured in the condition of combination with the following parts:

<< PoE operation >>

- PoE Switch GS108P-100AJS (NETGEAR Inc.)
- LAN Cable LD-TWST/BM30 (ELECOM CO., LTD)

<< DC operation >>

- DC Cable CPCBG-03
- LAN Cable LD-TWST/BM30 (ELECOM CO., LTD)

Please confirm the EMC adaptability when it combines with parts other than them.



# Functions

This section introduces standard functions of BG series. This camera series provides following functions.

List of Functions

Category	Function	
DeviceControl	DeviceControl	Get device information
ImageFormatControl	Scalable	Set scalable operation
	Decimation	Set decimation operation
	Reverse	Set image flipping operation
	PixelFormat	Select pixel format
	TestImageSelector	Select test pattern
AcquisitionControl	AcquisitionControl	Execute stream start / stop
	TriggerControl	Control trigger operation
	ExposureControl	Control exposure
DigitalIOControl	DigitalIOControl	Control GPIO signals
CounterAndTimerControl	TimerControl	Control Timer0Active signal
EventControl	EventControl	Control event packet
AnalogControl	Gain	Set gain
	BalanceRatio	Set color gain (R, B gain)
	BalanceWhiteAuto	Execute auto white balance once
	BlackLevel	Set black level
	Gamma	Set gamma correction
	BlackLevelCorrection	Set black level correction
LUTControl	LUTControl	Control LUT
TransportLayerControl	TransportLayerControl	Control transport layer
UserSetControl	UserSetControl	Load / Save user setting
ALCCControl	ALCCControl	Control ALC operation

Function	BG205MC-CS
DeviceControl	○
Scalable	○
Decimation	○
Reverse	○
PixelFormat	○
TestImageSelector	○
AcquisitionControl	○
TriggerControl	○
ExposureControl	○
DigitalIOControl	○
TimerControl	○
EventControl	○
Gain	○
BalanceRatio	○
BalanceWhiteAuto	○
BlackLevel	○
Gamma	○
BlackLevelCorrection	○
LUTControl	○
TransportLayerControl	○
UserSetControl	○
ALCControl	○

# DeviceControl

Registers of this category provide various information of the camera. And you can set the free user ID to the camera.

## ● Registers

Register	Visibility	Access	Description
DeviceScanType	Expert	R	Returns the scan type.
DeviceVendorName	Beginner	R	Returns the vendor name.
DeviceModelName	Beginner	R	Returns the model name.
DeviceManufacturerInfo	Beginner	R	Returns the manufacturer information.
DeviceVersion	Beginner	R	Returns the device version.
DeviceFirmwareVersion	Beginner	R	Returns the firmware version.
DeviceSFNCVersionMajor	Beginner	R	Returns the SFNC version of GenICam XML.
DeviceSFNCVersionMinor	Beginner	R	
DeviceSFNCVersionSubMinor	Beginner	R	
DeviceID	Beginner	R	Returns the Device ID (serial number).
DeviceUserID	Beginner	R/W	Set the free user ID.
DeviceRegistersStreamingStart	Guru	W	Executes inactivating the validation of consistency.
DeviceRegistersStreamingEnd	Guru	W	Executes activating the validation of the consistency.
DeviceRegistersCheck	Expert	W	Executes the validation of the current register set for consistency.
DeviceRegistersValid	Expert	R	Returns the result that executed "DeviceRegistersCheck". TRUE: Consistency, FALSE: Inconsistency

# Scalable

BG series provide the scalable mode that can read out defined area of the screen.

In the scalable mode, camera reads out only necessary area at the normal speed and reads out other area at high speed. The frame rate can be faster when the vertical height size is small. However, the frame rate cannot be faster only when the horizontal width size is small.

Only single rectangle is selectable. Concave or convex shape is not selectable.

- Window size:  $\{A + 4 \times m (H)\} \times \{B + 2 \times n (V)\}$   
 A, B = minimum unit size  
 m, n = integer  
 The window size is equal or less than maximum image size.
- Start address:  $\{4 \times i (H)\} \times \{2 \times j (V)\}$   
 i, j = integer  
 The window size is equal or less than maximum image size.

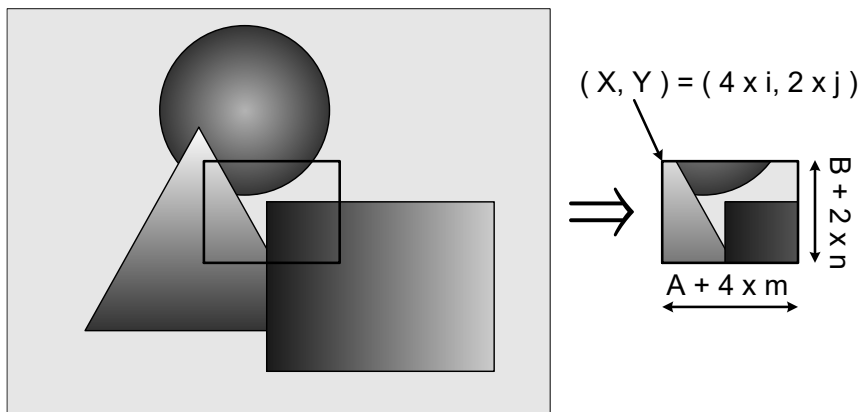

Scalable

## • Registers

Register	Visibility	Access	Description
SensorWidth	Beginner	R	Returns effective width of the sensor in pixels.
SensorHeight	Beginner	R	Returns effective Height of the sensor in pixels.
WidthMax	Expert	R	Returns maximum width (in pixels) of the image.
HeightMax	Expert	R	Returns maximum Height (in pixels) of the image.
Width	Beginner	R/W	Sets width (in pixels) of the image data.
Height	Beginner	R/W	Sets Height (in pixels) of the image data.
OffsetX	Beginner	R/W	Sets horizontal offset (in pixels) from the origin to the region of interest.
OffsetY	Beginner	R/W	Sets vertical offset (in pixels) from the origin to the region of interest.

## ● Setting

- Set image size and image start position

Set the following value to “Width”, “Height”, “OffsetX”, “OffsetY” registers. Setting value is Integer type. “Width”, “Height” registers are image size setting. “OffsetX”, “OffsetY” registers are image start position setting.

Model	BG205MC-CS
Width unit size	4
Height unit size	2
OffsetX unit size	4
OffsetY unit size	2
Minimum unit size	64×64
Maximum unit size (*)	2048×1088

\* initial factory setting

## ● Note

Changing “Width”, “Height”, “OffsetX”, “OffsetY” register value is invalid during image stream data output.

# Decimation

In the Decimation mode, camera outputs the image that thinned out the line(s). By thinning out the line(s) of the image, camera outputs all effective areas at high speed and decreases GigE bandwidth occupation.

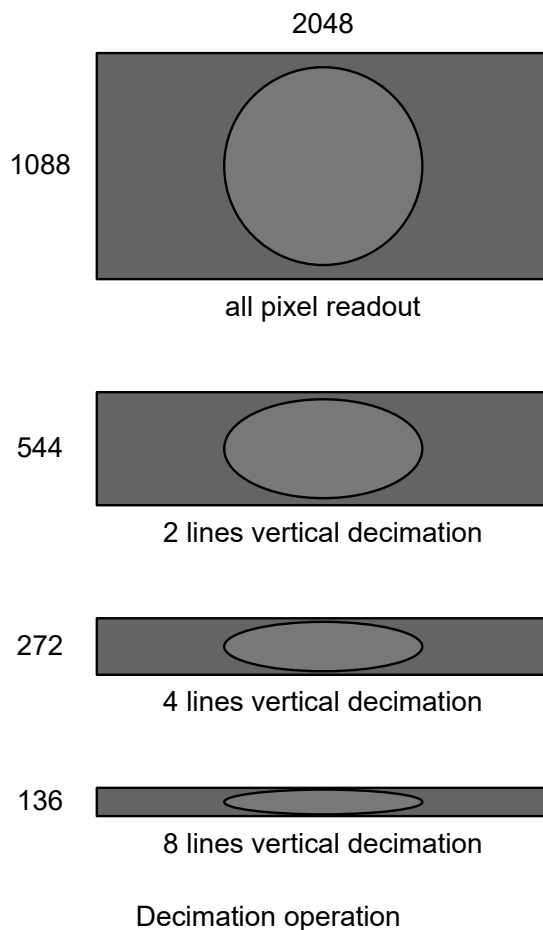

## • Registers

Register	Visibility	Access	Description
DecimationVertical	Beginner	R/W	Set the number of vertical Decimation line(s).

- **Setting**

- Set Decimation lines

- Set the following value to "DecimationVertical" registers. Setting value is Integer type.

- "DecimationVertical" is the number of line(s) to skip.

Model	BG205MC-CS
Minimum (*)	1
Value	1, 2, 4, 8
Maximum	8

\* initial factory setting

- **Note**

- Decimation function is disabled when the camera is running in Scalable mode.

- Scalable function is disabled when the camera is running in Decimation mode.

- Changing "DecimationVertical" register value is invalid during image stream data output.

# Reverse

Image can be flipped in horizontal and/or vertical direction.

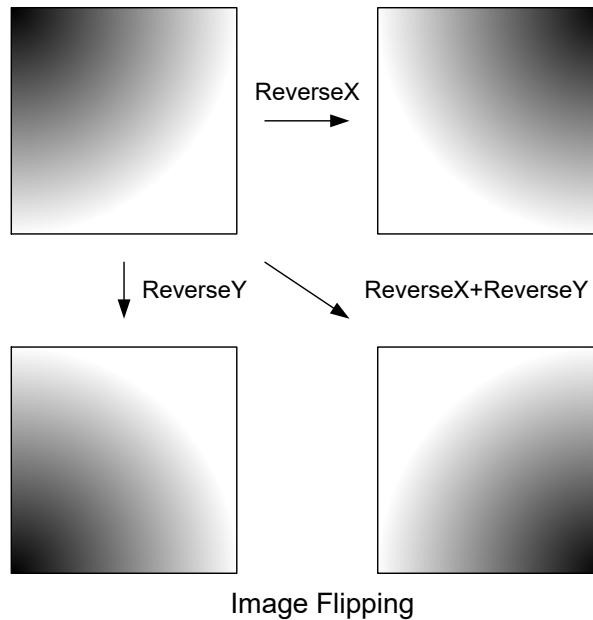

## • Registers

Register	Visibility	Access	Description
ReverseX	Expert	R/W	Flip image in horizontal direction.
ReverseY	Expert	R/W	Flip image in vertical direction.

## • Setting

- Set image reverse

Set the following value to "ReverseX", "ReverseY" registers. Setting value is Boolean type.

Value	Image reverse
FALSE (*)	Non reverse
TRUE	Reverse

\* initial factory setting



# PixelFormat

Select a pixel format of image stream data.

## ● Registers

Register	Visibility	Access	Description
PixelFormat	Beginner	R/W	Selects a pixel format.
PixelSize	Expert	R	Returns a bit size of image pixel.

## ● Setting

- Selects a pixel format

Set a following value to “PixelFormat” register. Setting value is Enumeration type.

ReverseX	ReverseY	Value	PixelFormat	PixelSize
False (*)	False (*)	BayerGR8	Bayer Green Red 8 bit	Bpp8: 8 bits per pixel
True	False	BayerRG8	Bayer Red Green 8 bit	
False	True	BayerBG8	Bayer Blue Green 8 bit	
True	True	BayerGB8	Bayer Green Blue 8 bit	

\* initial factory setting

## ● Note

Changing “PixelFormat” register value is invalid during image stream data output.

# TestImageSelector

BG series support test pattern data output. Camera provides following Test patterns;

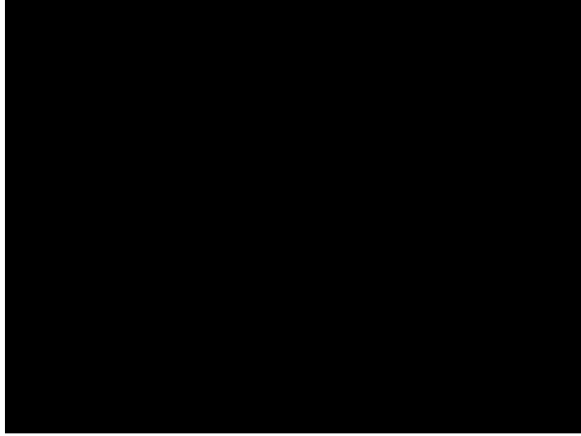

Black = Full screen 0 LSB @8bit

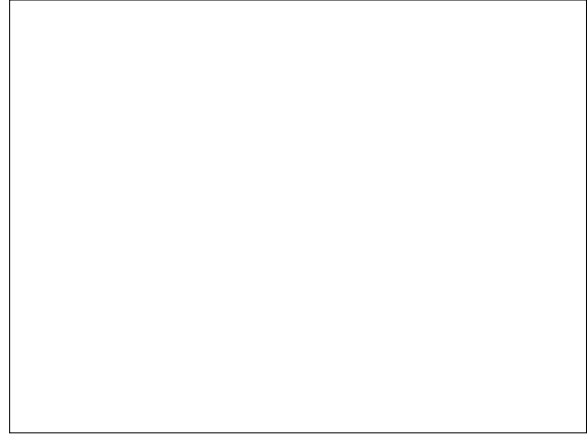

White = All pixels 255 LSB @8bit



BrightGrey = Full screen 85 LSB @8bit



DarkGrey = Full screen 170 LSB @8bit

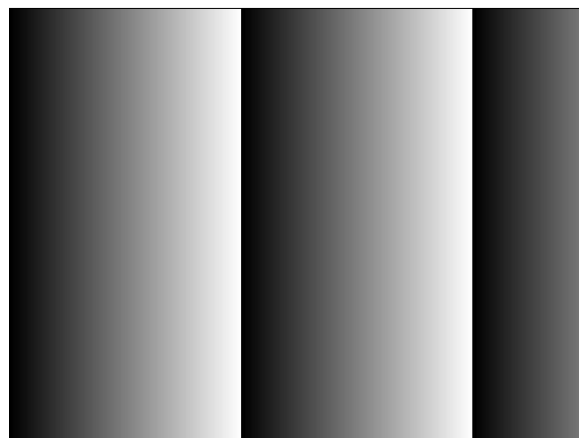

GreyHorizontalRamp

Test pattern

## ● Registers

Register	Visibility	Access	Description
TestImageSelector	Beginner	R/W	Selects a test pattern.

## ● Setting

- Select a test pattern output

Set the following value to “TestImageSelector” register. Setting value is Enumeration type.

The camera generates a test pattern.

Value	Function
Off (*)	Test pattern disable(Normal data output)
Black	All pixel = 0 LSB
White	All pixel = 255 @Mono8
BrightGrey	All pixel = 170 @Mono8
DarkGrey	All pixel = 85 @Mono8
GreyHorizontalRamp	Horizontal Ramp

\* initial factory setting

# AcquisitionControl

Make a setting of image stream and control image stream output.

Camera starts image stream output by receiving AcquisitionStart command. And there are some registers that require camera to stop image stream output to change values.

Acquisition frame rate is variable. Maximum acquisition frame rate depends on camera operation mode (scalable, binning, decimation, link speed, etc.)

## ● Registers

Register	Visibility	Access	Description
AcquisitionMode	Beginner	R	Returns acquisition mode.
AcquisitionStart	Beginner	W	Executes the image stream output start.
AcquisitionStop	Beginner	W	Executes the image stream output stop.
AcquisitionAbort	Beginner	W	Executes the image stream output abort.
AcquisitionFrameBurstCount	Beginner	R/W	Sets number of Exposures to acquire for each FrameBurstStart trigger.
AcquisitionFrameRate	Beginner	R/W	Sets frame rate of image stream.

## ● Setting

- Start image stream output

The camera starts image stream output by executing “AcquisitionStart” register command.

- Stop image stream output

The camera stops image stream output by executing “AcquisitionStop” register command.

The camera aborts image stream output by executing “AcquisitionAbort” register command.

- Sets number of Exposures for FrameBurstStart trigger

Set the following value to “AcquisitionFrameBurstCount” register. Setting value is Integer type.

FrameBurstCount	Value
Minimum (*)	1 [time]
Maximum	255 [times]

\* initial factory setting

- Sets frame rate

Set the following value to "AcquisitionFrameRate" register. Setting value is Float type.

The range of register setting depends on camera model, and camera operation mode.

FrameRate	Value
Minimum	0.0625[Hz]
Maximum (*)	Depend on register setting of "Height", "Binning", "Decimation", "PacketSize" and "PixelFormat" or link speed of interface.

\* initial factory setting

● **Note**

Changing "AcquisitionFrameRate" register value is invalid during image stream data output.

When exposure time setting is longer than frame rate setting, camera operation gives priority to exposure time setting.

**Notes on Frame Drops of Image:**

Depends on your PC or Gigabit Ethernet interface board configurations, images may not be captured normally (e.g. frame drops may occur). In this case, change to frame rate setting lower.

# TriggerControl

This section describes trigger control of AcquisitionControl category for the BG series.

This camera series provides two kinds of exposure synchronization.

1. Normal Shutter mode : Free run operation (internal synchronization)
2. Random Trigger Shutter mode : Synchronized with external trigger input

In Random Trigger Shutter mode, two kinds of trigger input are available.

1. Trigger signal via the I/O connector (HardwareTrigger)
2. Trigger command via the Gigabit Ethernet interface (SoftwareTrigger)

The following table shows the combination of operation mode of this camera series.

Operation Mode

Trigger Mode (TriggerMode)	Synchronization (TriggerSource)	Exposure Control (ExposureAuto / ExposureMode)	Trigger Type (TriggerSelector)
Normal Shutter mode (Off)	Free run (Don't Care)	"ExposureTime" register control (Off / Timed)	Free run (Don't Care)
		ALC control (On / Timed)	
Random Trigger Shutter mode (On)	HardwareTrigger (Line0)	"ExposureTime" register control (Off / Timed)	Normal Trigger mode (FrameStart)
		Trigger pulse width control (Off / TriggerWidth)	FrameBurst mode (FrameBurstStart)
	SoftwareTrigger (Software)	"ExposureTime" register control (Off / Timed)	Normal Trigger mode (FrameStart)
			FrameBurst mode (FrameBurstStart)

\* The camera operation not mentioned above is not guaranteed.

## - Trigger Polarity

Operation point of HardwareTrigger is at the edge of trigger signal, and active edge polarity is able to change by register setting.

- Trigger Delay

And you can add delay time from trigger edge to exposure start by register setting.

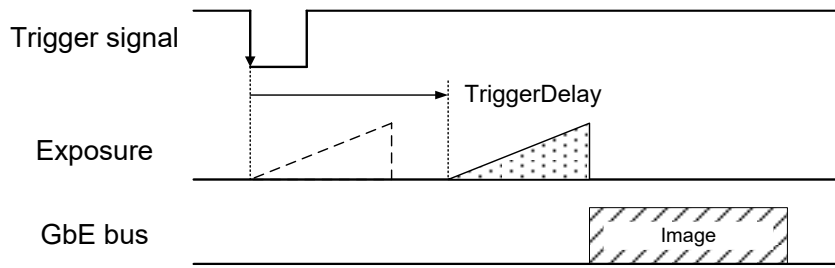

Trigger Delay

- Trigger Type

1. FrameStart: Camera exposes and transfers a single frame by a single trigger.

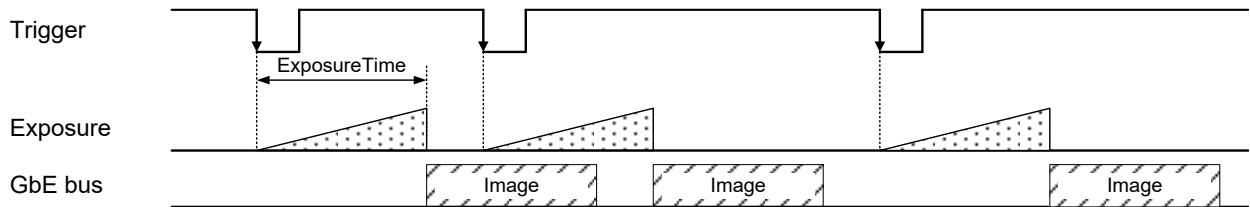

2. FrameBurstStart: Camera exposes and transfers multiple frames by a single trigger.

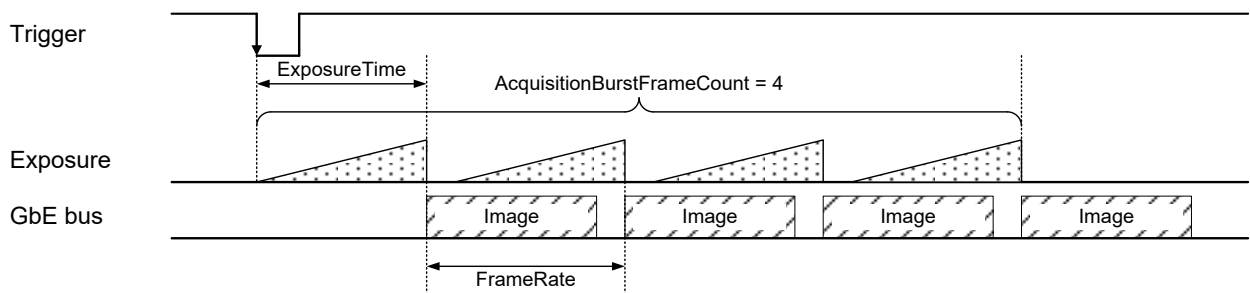

Trigger Type

- Anti-Chattering

Anti-Chattering control filters noise and unstable logic value of the trigger input signal.

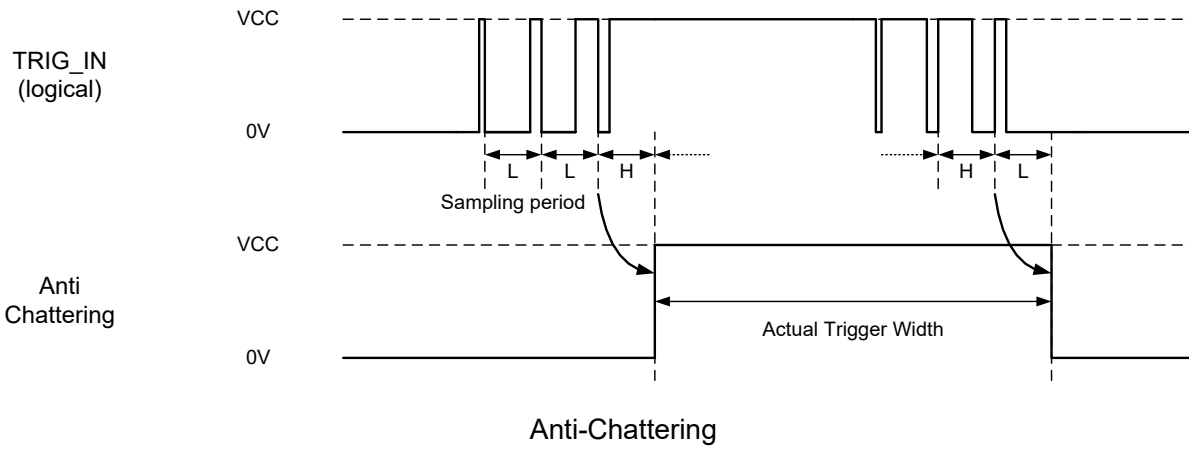

Details of Random Trigger Shutter operation, refer to "Timing" of "Specification".

● Registers

Register	Visibility	Access	Description
TriggerSelector	Beginner	R/W	Selects the type of trigger.
TriggerMode	Beginner	R/W	Selects Random Trigger Shutter mode.
TriggerSoftware	Beginner	W	Executes software trigger.
TriggerSource	Beginner	R/W	Selects trigger source of Random Trigger Shutter.
TriggerActivation	Beginner	R/W	Selects trigger polarity of hardware trigger.
TriggerDelay	Expert	R/W	Sets trigger delay.
TriggerSamplingPeriod	Expert	R/W	Sets sampling period for Anti-Chattering.



## ● Setting

- Selects trigger type

Set the following value to “TriggerSelector” register. Setting value is Enumeration type.

Value	Operation Mode
FrameStart(*)	Normal Trigger mode
FrameBurstStart	FrameBurst mode

\* initial factory setting

- Selects trigger mode

Set the following value to “TriggerMode” register. Setting value is Enumeration type.

Value	Operation Mode
Off (*)	Normal Shutter Mode
On	Random Trigger Shutter mode

\* initial factory setting

- Selects trigger source

Set the following value to “TriggerSource” register. Setting value is Enumeration type.

Value	Trigger source
Line0 (*)	Hardware trigger
Software	Software trigger

\* initial factory setting

- Grabs image stream by software trigger

When executes “TriggerSoftware” register command, software trigger command is generated. And the camera starts exposure by receiving software trigger command in software trigger mode.

- Changes trigger polarity (HardwareTrigger operation only)

Set the following value to “TriggerActivation” register. Setting value is Enumeration type.

Value	Polarity
FallingEdge (*)	Negative
RisingEdge	Positive

\* initial factory setting

- Sets trigger delay (HardwareTrigger operation only)

Set the following value to “TriggerDelay” register. Setting value is Float type.

Adds delay time from trigger edge to exposure start.

TriggerDelay	Value
Minimum (*)	0.00[ $\mu$ s]
Maximum	4095.00[ $\mu$ s]

\* initial factory setting

- Sets sampling period for Anti-Chattering (HardwareTrigger operation only)

Set the following value to “TriggerSamplingPeriod” register. Setting value is Float type.

TriggerSamplingPeriod[ $\mu$ s]	Value
Minimum (*)	2.00[ $\mu$ s]
Maximum	1000.00[ $\mu$ s]

\* initial factory setting

## ● Note

Changing “TriggerMode”, “TriggerSource”, “TriggerActivation” registers value is invalid during image stream data output.

In SoftwareTrigger operation, it takes less than 1ms from “TriggerSoftware” command to exposure start.

When set longer value to “TriggerSamplingPeriod” register, noise immunity of trigger input line is improved, but the delay time of receiving trigger signal become longer.

# ExposureControl

BG series is able to adjust exposure time by using electric shutter control.

This camera series provides two kinds of exposure time control mode.

- MANUAL mode : The exposure time is determined by "ExposureTime" register setting value.
- AE mode : The exposure time is adjusted automatically by the photometry of the image.

By combining AE mode and AGC (ALC mode), it can adjust a wide range of brightness fluctuation of the subject. About details of ALC mode, refer to "ALC Control" of "Functions".

When HardwareTrigger operation, you are able to control the exposure time by pulse width of external trigger input signal.

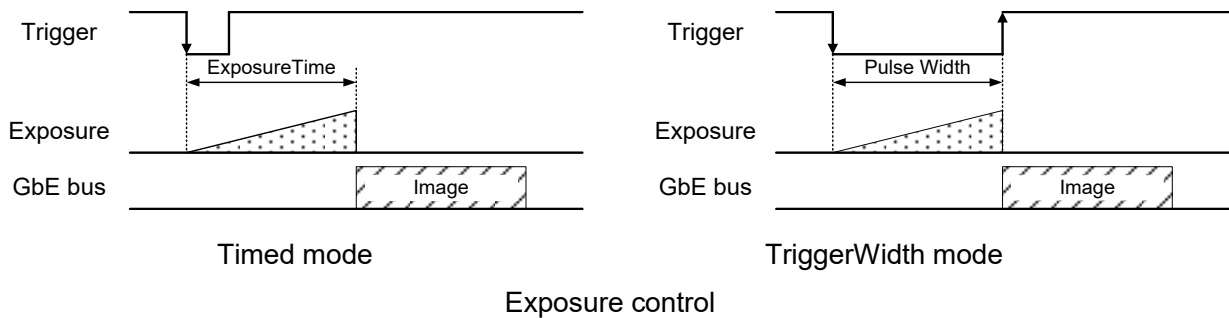

## ● Registers

Register	Visibility	Access	Description
ExposureMode	Beginner	R/W	Selects manual exposure mode.
ExposureTime	Beginner	R/W	Sets absolute exposure time(timed mode).
ExposureAuto	Beginner	R/W	Sets AE operation.

## ● Setting

- Selects exposure control mode

Set the following value to “ExposureMode” register. Setting value is Enumeration type.

Value	Manual exposure mode
Timed (*)	“ExposureTime” register control
TriggerWidth	Trigger pulse width control

\* initial factory setting

In Normal Shutter mode, the exposure time is determined by “ExposureTime” register value regardless of “ExposureMode” register setting.

- Sets exposure time (timed mode only)

Set the following value to “ExposureTime” register. Setting value is Float type.

Set the exposure time of Normal Shutter mode, and Random Trigger Shutter -Timed mode operation.

Model	Value
ExposureTime (*)	20000 [μs]
ExposureTimeMin	10 [μs]
ExposureTimeMax	1000000 [μs]

\* initial factory setting

- Set auto exposure

Set the following value to “ExposureAuto” register. Setting value is Enumeration type.

Select the exposure control.

Value	Function
Off (*)	Manual Exposure control
On	Auto Exposure control

\* initial factory setting

## ● Note

Changing “ExposureMode” register value is invalid during image stream data output.

# DigitalIOControl

This section describes DigitalIOControl category for the BG series.

This camera provides GPIO output selected by the register setting. And the polarity of the signal is able to switch by the register setting. The following chart shows the specifications of the selectable signals.

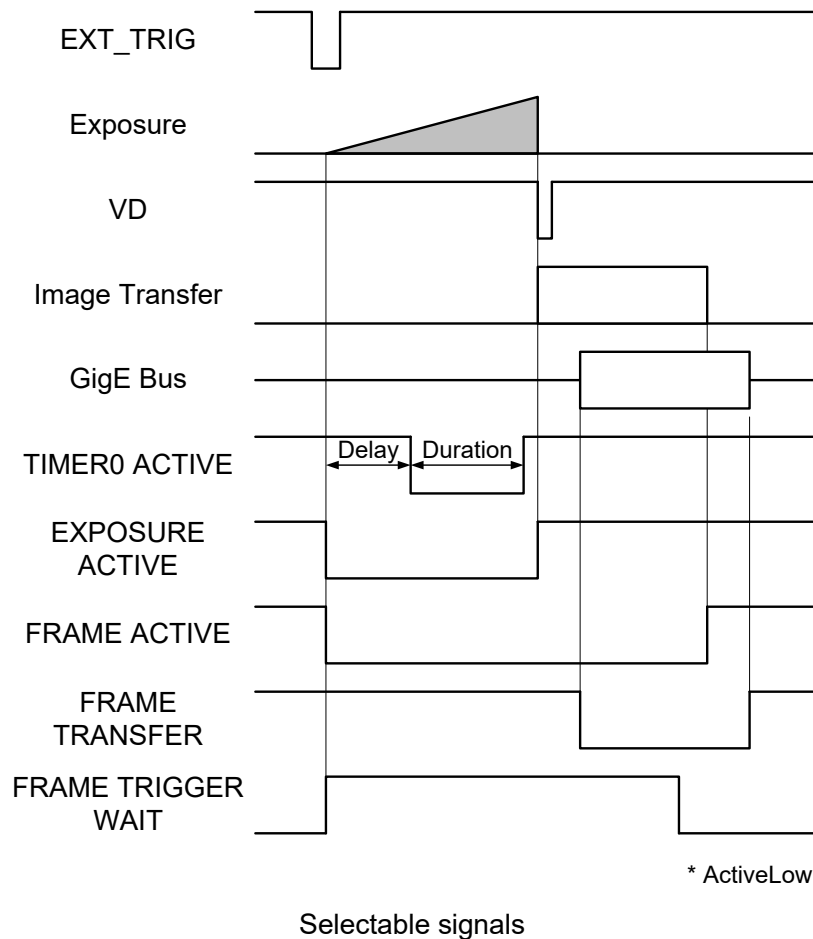

## • Registers

Register	Visibility	Access	Description
LineSelector	Expert	R/W	Selects the Line of I/O connector.
LineMode	Expert	R	Returns the direction of each Line signal.
LineInverter	Expert	R/W	Selects the polarity of GPIO output signal.
LineSource	Expert	R/W	Selects the source of the output signal.
LineFormat	Expert	R	Returns the type of each Line signal.

## ● Setting

- Select the Line of the I/O connector

Set the following value to “LineSelector” register. The setting value is Enumeration type.

LineSelector	I/O connector pin assignment	LineMode	LineFormat
Line0 (*)	2 pin: External Trigger Input	Input	OptoCoupled: OpenCollector
Line1	3 pin: GPIO0 Output	Output	TTL: LVTTTL
Line2	4 pin: GPIO1 Output	Output	OptoCoupled: OpenCollector

\* initial factory setting

- Select the polarity of GPIO output signal

Set the following value to “LineInverter” register. The setting value is Boolean type.

Value	Polarity
FALSE (*)	ActiveLow
TRUE	ActiveHigh

\* initial factory setting

- Select the source of GPIO output signal

Set the following value to “LineSource” register. Setting value is Enumeration type.

Value	Signal description
Off (*)	No output.
FrameTriggerWait	Indicating waiting a Random Trigger Shutter. An External trigger is input during this period, exposure starts immediately.
FrameTransfer	Period of transferring image data on Ethernet bus.
FrameActive	Period from exposure start to image transfer completion.
ExposureActive	Period from exposure start to exposure end.
Timer0Active	This signal can be used as strobe control signal. The delay time and pulse width of this signal are configurable.
VD	Internal VD sync signal.

\* initial factory setting

## ● Note

About the details of Timer0Active signal, refer to “TimerControl” of "Functions".

# TimerControl

This section describes TimerControl category for the BG series.

This camera series is able to generate Timer0Active signal, derived from exposure start, by register setting.

This signal can be used as strobe control signal.

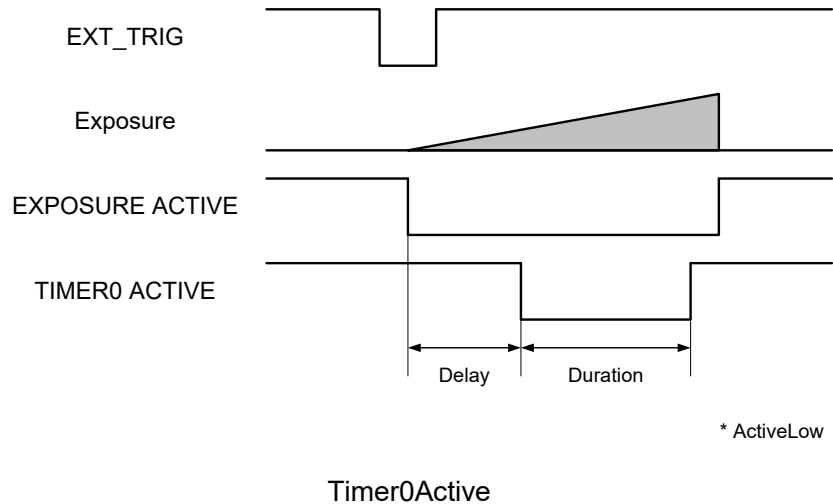

## ● Registers

Register	Visibility	Access	Description
TimerSelector	Expert	R	Returns the name of the timer that selected.
TimerDuration	Expert	R/W	Sets the width of Timer0Active signal.
TimerDelay	Expert	R/W	Sets the delay of Timer0Active signal.
TimerTriggerSource	Expert	R	Returns the timing that is the basic of the timer

## ● Setting

- Set the width of Timer0Active pulse

Set the following value to "TimerDuration" register. Setting value is Float type.

Pulse width	Value
Minimum (*)	0.00[μs]
Maximum	2000000.00[μs]

\* initial factory setting

- Set the delay of Timer0Active pulse

Set the following value to "TimerDelay" register. Setting value is Float type.

Delay	Value
Minimum (*)	0.00[ $\mu$ s]
Maximum	2000000.00[ $\mu$ s]

\* initial factory setting



# EventControl

This section describes EventControl category for the BG series.

This camera series provides Event notifications of ALC and trigger operation information.

The detail of Event notifications is following;

- FrameTrigger : Reception of Frame Start Trigger
- FrameTriggerError : Rejection of Frame Start Trigger
- FrameTriggerWait : Start of waiting for Frame Start Trigger
- ALCLastestInformation : ALC Information is updated
- ALCConverged : ALC is converged

FrameTrigger events timing are as following chart.

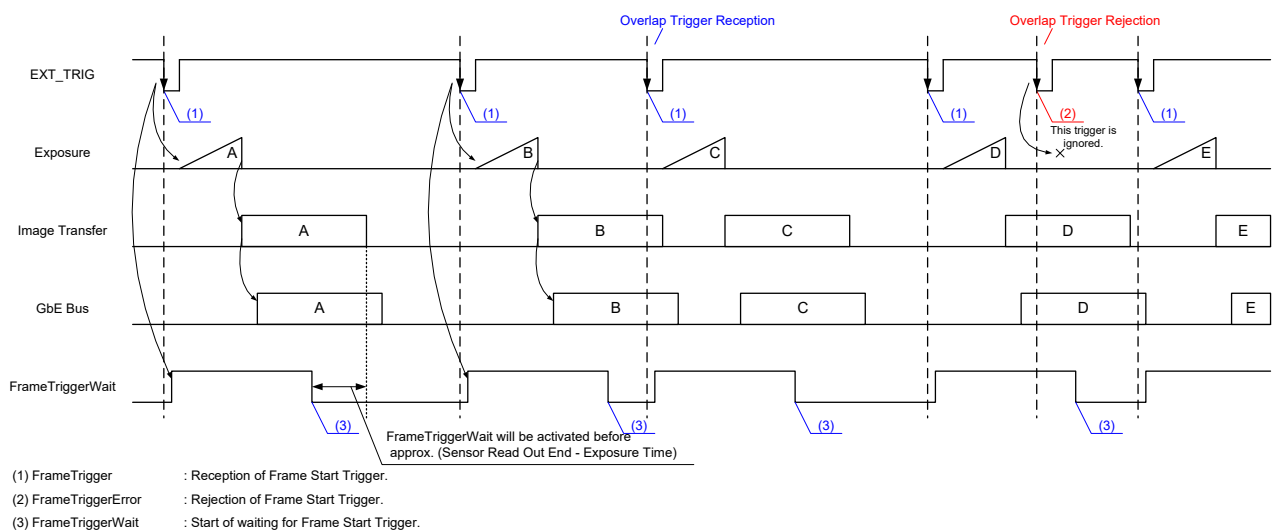

FrameTrigger / Error / Wait Event timing

## ● Registers

Register	Visibility	Access	Description
<b>EventControl</b>			
EventSelector	Expert	R/W	Selects the type of Event notifications.
EventNotification	Expert	R/W	Sets the activation of Event notifications.
<b>EventFrameTriggerData</b>			
EventFrameTrigger	Expert	R	Returns Event ID of FrameTrigger type.
EventFrameTriggerTimestamp	Expert	R	Returns the timestamp at the time of Event.
<b>EventFrameTriggerErrorData</b>			
EventFrameTriggerError	Expert	R	Returns Event ID of FrameTriggerError type.
EventFrameTriggerErrorTimestamp	Expert	R	Returns the timestamp at the time of Event.
<b>EventFrameTriggerWaitData</b>			
EventFrameTriggerWait	Expert	R	Returns Event ID of FrameTriggerWait type.
EventFrameTriggerWaitTimestamp	Expert	R	Returns the timestamp at the time of Event.
<b>EventALCLatestInformationData</b>			
EventALCLatestInformation	Expert	R	Returns Event ID of ALCLatestInformation type.
EventALCLatestInformationTimestamp	Expert	R	Returns the timestamp at the time of Event.
EventALCLatestInformationTotalLuminance	Expert	R	Returns the total luminance at the time of Event.
EventALCLatestInformationAverageLuminance	Expert	R	Returns the average luminance at the time of Event.
EventALCLatestInformationExposureTime	Expert	R	Returns the exposure time at the time of Event.
EventALCLatestInformationGain	Expert	R	Returns the gain at the time of Event.
<b>EventALCConvergedData</b>			
EventALCConverged	Expert	R	Returns Event ID of ALCConverged type.
EventALCConvergedTimestamp	Expert	R	Returns the timestamp at the time of Event.
EventALCConvergedLuminanceTotal	Expert	R	Returns the total luminance at the time of Event.
EventALCConvergedLuminanceAverage	Expert	R	Returns the average luminance at the time of Event.
EventALCConvergedExposureTime	Expert	R	Returns the exposure time at the time of Event.
EventALCConvergedGain	Expert	R	Returns the gain at the time of Event.

## ● Setting

- Select the type of Event notifications

Set the following value to “EventSelector” register. The setting value is Enumeration type.

Value	Type of Event notification
FrameTrigger (*)	Information of trigger operation
FrameTriggerError	Error information of trigger operation
FrameTriggerWait	Information of wait for trigger input
ALCLatestInformation	Information of ALC update
ALCConverged	Information of ALC convergence

\* initial factory setting

- Set the activation of Event notifications

Set the following value to “EventNotification” register. The setting value is Enumeration type.

Value	Event notification
Off (*)	Inactive
On	Active

\* initial factory setting

## ● Note

This camera takes about 4 ms to event notification.

# Gain

This section describes Gain control of AnalogControl category for the BG series.

This control adjusts the gain of the image.

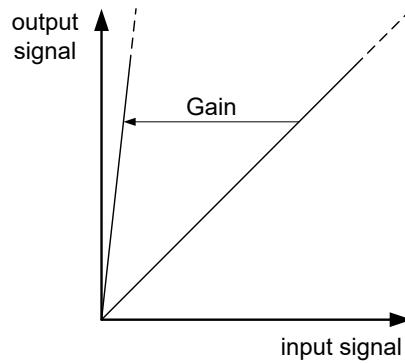

Gain

This camera series provides two kinds of Gain control mode.

- ManualControl (MANUAL) : The Gain value is determined by “Gain” register setting value.
- AutoGainControl (AGC) : The Gain value is adjusted automatically by the photometry of the image.

## ● Registers

Register	Visibility	Access	Description
GainSelector	Beginner	R	Returns the luminance component of Gain setting.
Gain	Beginner	R/W	Sets the absolute Gain.
GainAuto	Beginner	R/W	Sets activation of AGC mode.

## ● Setting

### - Set Manual Gain

Set the following value to “Gain” register. Setting value is Float type. This setting value is valid only at Manual Gain mode setting.

Gain	Value
Minimum (*)	0.00 [dB]
Maximum	18.00 [dB]

\* initial factory setting

The formula of Gain value is as follows;

$$\text{output signal} = \text{input signal} \times 10^{\frac{\text{Gain}}{20}}$$

### - Select Gain control mode

Set the following value to “GainAuto” register. Setting value is Enumeration type.

Value	Mode
Off (*)	Manual Gain Control (MANUAL)
Continuous	Auto Gain Control (AGC)

\* initial factory setting

## ● Note

About the details of AGC mode, refer to “ALCCControl” of "Functions".

### **Notes on gain setting:**

Setting the gain value too high increases noises. When you adjust the brightness of the image, I ask you to have final image quality checked with your environment.

# BalanceRatio

This section describes BalanceRatio control of AnalogControl category for the BG series.  
This control adjusts the white balance gain of the image.

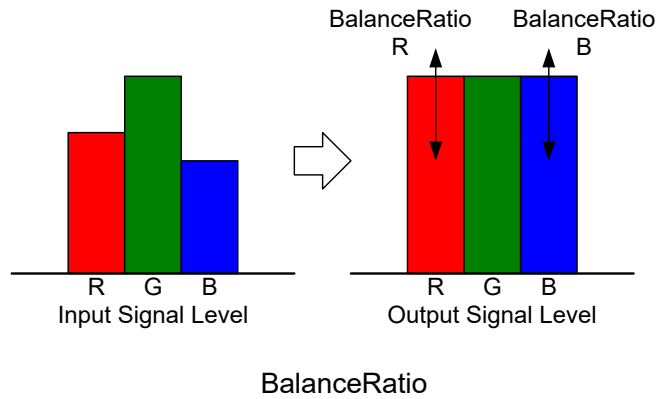

## • Registers

Register	Visibility	Access	Description
BalanceRatioSelector	Expert	R/W	Selects a color component of white balance gain to control.
BalanceRatio	Expert	R/W	Sets a white balance gain.

## ● Setting

### - Select BalanceRatio

Select the color component of white balance gain to control in “BalanceRatioSelector” register.

Setting value is Enumeration type.

Value	Function
R (*)	BalanceRatio = R Gain
B	BalanceRatio = B Gain

\* initial factory setting

### - Set BalanceRatio

Set the following value to “BalanceRatio” register. The value is to be applied to selected color component.

Setting value is Float type.

BalanceRatio	Value
Minimum	x 0.5
Maximum	x 8.0

\* initial factory setting = x 1.0

### **Notes on white balance gain setting:**

Too high white balance gain increases noises. After adjusting the white balance of the image, I ask you to have final image quality checked with your environment.

# BalanceWhiteAuto

Adjust white balance gain automatically.

## ● Registers

Register	Visibility	Access	Description
BalanceWhiteAuto	Expert	R/W	Adjust white balance gain automatically.

## ● Setting

- Set BalanceWhiteAuto

Set the following value to “BalanceWhiteAuto” register.

After setting “Once”, camera executes auto white balance once. If execution of auto white balance is successful, both R and B gain are applied to BalanceRatio respectively.

Value	Function
Off (*)	No operation
Once	Execute auto white balance once.

\* initial factory setting

## ● Note

BalanceRatio and BalanceWhiteAuto controls are available in following PixelFormat modes.

Bayer\*8



# BlackLevel

This section describes BlackLevel control of AnalogControl category for the BG series.

This control adjusts the black level of the image. It is adjustable from -5% to +25% as white saturation level is 100%. However, when BlackLevel is lower than 0[%], the image level may not be saturated.

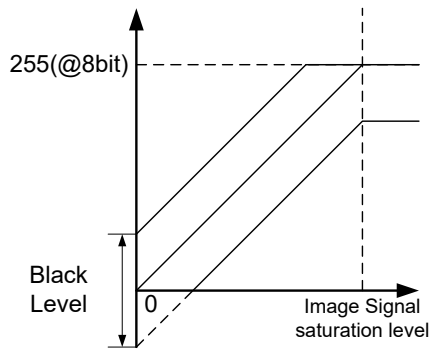

Black Level

## ● Registers

Register	Visibility	Access	Description
BlackLevelSelector	Beginner	R	Returns the luminance component of Black Level setting.
BlackLevel	Beginner	R/W	Sets the absolute Black Level.

## ● Setting

- Set Black Level

Set the following value to “BlackLevel” register. Setting value is Float type.

BlackLevel	Value
Minimum	-5.00[%]
Maximum	+25.00[%]

\* initial factory setting = 0.00[%]

# Gamma

This section describes Gamma correction of AnalogControl category for the BG series.

This function allows you to apply a gamma correction to the output images.

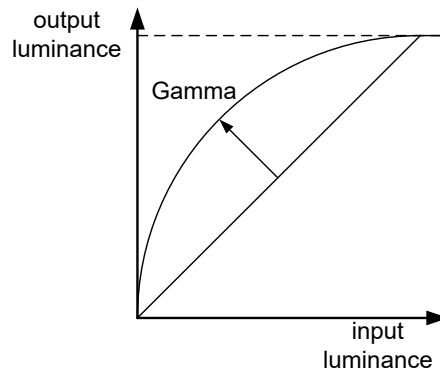

Gamma correction

## • Registers

Register	Visibility	Access	Description
Gamma	Beginner	R/W	Sets the Gamma correction.

## • Setting

- Set Gamma correction

Set the following value to “Gamma” register. Setting value is Float type.

Gamma	Value
Minimum	0.45
Maximum (*)	1.00

\* initial factory setting

# BlackLevelCorrection

Image black level of this product changes by using image sensor characteristics. Changes of the image black level depends on the exposure time setting and temperature of the image sensor. By enabling this function, changes of the image black level is reduced.

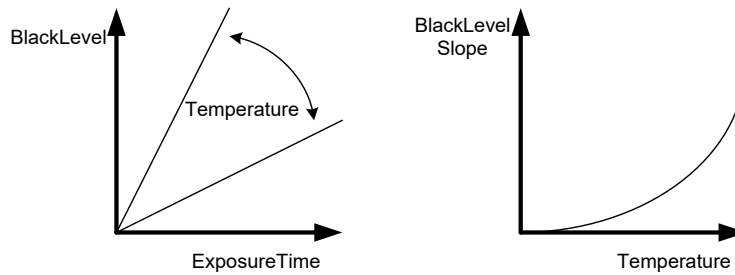

Black level correction

## ● Registers

Register	Visibility	Access	Description
BlackLevelCorrectionMode	Guru	R/W	Sets the BlackLevel correction.

## ● Setting

- Set BlackLevel correction

Set the following value to “BlackLevelCorrectionMode” register. Setting value is Enumeration type.

Value	Mode
Off (*)	Inactivating BlackLevel Correction
On	Activating BlackLevel Correction

\* initial factory setting

## ● Note

By enabling this function, the changing of the black level is reduced, but can not be removed completely. If you want to further reduce the level, please set the short ExposureTime(<100ms) and lower the camera temperature.

When enabling this function and the black level is corrected, there is the case where the saturation level of the image brightness is lower in accordance with the correction amount. In this case, please adjust the Gain setting.

In the case of TriggerWidth mode of RamdomTriggerShutter, this function is invalidation.

When change the ExposureTime setting or the camera temperature, may result in over-correction by correction tracking speed.

# LUTControl

This section describes LUTControl category for the BG series.

This function allows you to apply the arbitrary LUT(input: 10bit, output: 10bit) to the output images.

## ● Registers

Register	Visibility	Access	Description
LUTSelector	Expert	R	Returns the luminance component of LUT process.
LUTEnable	Expert	R/W	Sets the activation of LUT process.
LUTIndex	Guru	R/W	Sets the input level of LUT process.
LUTValue	Guru	R/W	Sets the output level of LUT process.

## ● Setting

- Set the activation of LUT

Set the following value to “LUTEnable” register. The setting value is Boolean type.

Value	Function
FALSE (*)	Inactivation
TRUE	Activation

\* initial factory setting

- Set the input/output value of LUT

Set the following value to “LUTIndex”, “LUTValue” registers. These setting values are Integer type.

“LUTIndex” register value is input level of LUT process, and “LUTValue” register value is output level of LUT process.

LUTIndex / LUTValue	Value
Minimum (*)	0
Maximum	1023

\* initial factory setting

# TransportLayerControl

This section describes TransportLayerControl category for the BG series.

This camera series conforms to GigE vision 1.2 and GenICam 2.3

## ● Registers

Register	Visibility	Access	Description
PayloadSize	Expert	R	Returns the payload size of the image data.
GevVersionMajor	Expert	R	Returns the version of the GigE Vision protocol.
GevVersionMinor	Expert	R	
GevDeviceModelsBigEndian	Guru	R	Returns the endian of the register. True: BigEndian, False: LittleEndian
GevDeviceClass	Guru	R	Returns the device class of this camera.
GevDeviceModeCharacterSet	Guru	R	Returns the character set of the string register.
GevInterfaceSelector	Beginner	R	Returns physical network interface to control.
GevMACAddress	Beginner	R	Returns MAC address of the network interface.
GevSupportedOptionSelector	Expert	R/W	Selects the GEV option to interrogate for existing support.
GevSupportedOption	Expert	R	Returns if the selected GEV option is supported.
GevCurrentIPConfigurationLLA	Beginner	R/W	Sets the activation of LLA IP Configuration.
GevCurrentIPConfigurationDHCP	Beginner	R/W	Sets the activation of DHCP IP Configuration.
GevCurrentIPConfigurationPersistentIP	Beginner	R/W	Sets the activation of Persistent IP Configuration.
GevCurrentIPAddress	Beginner	R	Returns Current IP Address.
GevCurrentSubnetMask	Beginner	R	Returns Current IP Subnet Mask.
GevCurrentDefaultGateway	Beginner	R	Returns Current IP Default Gateway.
GevIPConfigurationStatus	Beginner	R	Returns Current IP Configuration.
GevFirstURL	Guru	R	Returns First URL of GenICam XML.
GevSecondURL	Guru	R	Returns Second URL of GenICam XML.
GevNumberOfInterfaces	Expert	R	Returns the number of physical network interfaces.
GevPersistentIPAddress	Beginner	R/W	Sets Persistent IP Address.
GevPersistentSubnetMask	Beginner	R/W	Sets Persistent IP Subnet Mask.
GevPersistentDefaultGateway	Beginner	R/W	Sets Persistent IP Default Gateway.
GevLinkSpeed	Expert	R	Returns the speed of transmission negotiated.

Register	Visibility	Access	Description
GevMessageChannelCount	Expert	R	Returns the number of message channels supported.
GevStreamChannelCount	Expert	R	Returns the number of stream channels supported.
GevHeartbeatTimeout	Guru	R/W	Sets the current heartbeat timeout [ms]. Initial factory setting: 3000[ms], Setting range: 0~4294967295[ms]
GevTimestampTickFrequency	Beginner	R	Returns the number of timestamp ticks [Hz].
GevTimestampControlLatch	Expert	W	Latches the current timestamp counter into GevTimestampValue.
GevTimestampControlReset	Expert	W	Resets the timestamp counter to 0.
GevTimestampValue	Expert	R	Returns the latched 64-bit value of the timestamp counter.
GevDiscoveryAckDelay	Expert	R/W	Sets the maximum randomized delay of the Discovery ACK command [ms]. Initial factory setting: 50 [ms], Setting range: 0~1000 [ms]
GevGVCPHeartbeatDisable	Expert	R/W	Disables the GVCP heartbeat. True: Disable, False: Enable
GevCCP	Guru	R/W	Sets the device access privilege of an application.
GevPrimaryApplicationSocket	Guru	R	Returns the UDP source port of the primary application.
GevPrimaryApplicationIPAddress	Guru	R	Returns the address of the primary application.
GevMCPHostPort	Guru	R/W	Sets the port to which the device must send messages.
GevMCDA	Guru	R/W	Sets the destination IP address for the message channel.
GevMCTT	Guru	R/W	Sets the transmission timeout value of the message channel [ms]. Initial factory setting: 300 [ms], Setting range: 0~4294967295 [ms]
GevMCRC	Guru	R/W	Sets the number of retransmissions of the message channel. Initial factory setting: 2, Setting range: 0~4294967295
GevMCSP	Guru	R	Returns the source port for the message channel.
GevStreamChannelSelector	Expert	R	Returns the stream channel to control.
GevSCPDiretion	Guru	R	Returns the direction of the stream channel.
GevSCPIInterfaceIndex	Guru	R	Returns Index of network interface of the stream channel.
GevSCPHostPort	Guru	R/W	Sets the port of the stream channel.
GevSCPSFireTestPacket	Guru	R/W	Sets the activation of the test packet. True: Active, False: Inactive
GevSCPSDoNotFragment	Guru	R/W	Sets the "do not fragment" bit of IP header of each stream packet. True: Enable, False: Disable
GevSCPSBigEndian	Guru	R/W	Selects the endian of multi-byte pixel data for this stream. True: BigEndian, False: LittleEndian
GevSCPSPacketSize	Expert	R/W	Sets the stream packet size [byte/packet].
GevSCPD	Expert	R/W	Sets the delay to insert between each packet for the stream channel.
GevSCDA	Guru	R/W	Sets the destination IP address of the stream channel.
GevSCSP	Guru	R	Returns the source port of the stream channel.
BlockStartDelay	Expert	R/W	Sets the delay to insert between each image frame for the stream channel.

● **Setting**

- Set the IP Configuration

Set the following value to “GevCurrentIPConfigurationLLA”, “GevCurrentIPConfigurationDHCP”, “GevCurrentIPConfigurationPersistentIP” registers. These setting values are Boolean type.

Set these registers in conformity with your system.

Value	IPConfiguration
FALSE	Inactive
TRUE	Active

- Set the camera access privilege of an application.

Set the following value to “GevCCP” register. The setting value is Enumeration type.

You can configure multi host system by using this function.

Value	Access Right
OpenAccess	Secondary access that can only monitor the image and read the register. (MonitorAccess)
ExclusiveAccess (*)	Primary access that can monitor the image and control the register. Other host can not access the camera.
ControlAccess	Primary access that can monitor the image and control the register. Other host can have privilege of Secondary access only.

\* initial factory setting

- Set the Packet Size of the stream channel

Set the following value to “GevSCPSPacketSize” register. The setting value is Integer type.

Set the register in conformity with your system (NIC, Switching HUB and the network condition). If the register setting is not in conformity with your system, your host can not grab the image properly.

PacketSize	Value
Minimum	72[byte/packet]
Maximum	16364[byte/packet]

\* initial factory setting = 1500[byte/packet]

**Notes on packet size setting:**

When the packet size setting is less than 1500[byte/packet], image may not be captured properly (e.g. dropping frames). In this case, change the packet size more than 1500[byte/packet].

And we recommend you to use network equipments (NIC, Switching HUB, etc. ) supporting Jumbo Frame.

- Set the SCPD and BlockStartDelay

Set the following value to “GevSCPD”, “BlockStartDelay” registers. These setting values are Integer type.

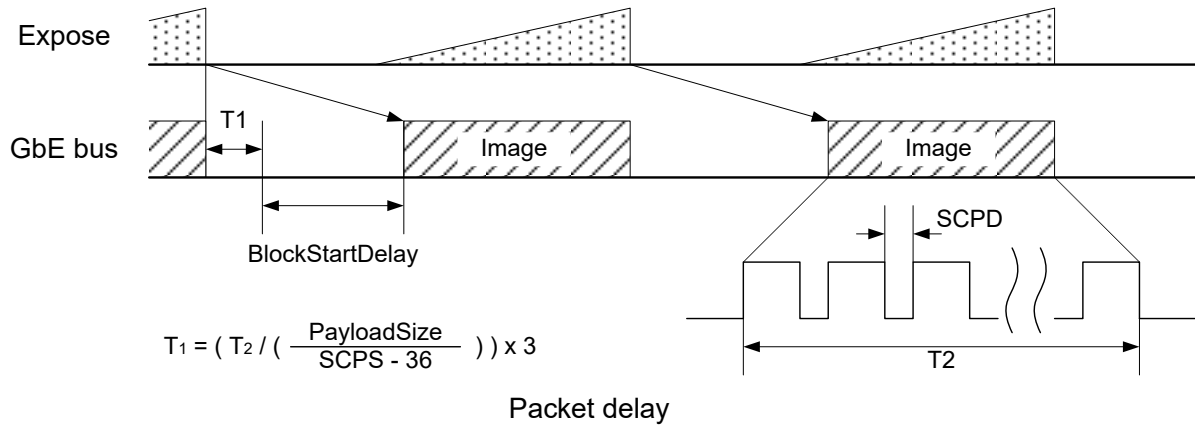

Value	GevSCPD	BlockStartDelay
Minimum (*)	0	0
Maximum	0xFFFFFFFF	0xFFFFE795

\* initial factory setting

\* unit of value = 8ns



# UserSetControl

This section describes UserSetControl category for the BG series.

You are able to save a user setting to the non-volatile memory of the camera. There are three user memory banks for user setting.

By using user memory, you are able to restore frequently used settings at the time of next start-up.

The following table is the list of registers applied by “UserSetLoad”/“UserSetSave”.

The register list applied by “UserSetLoad”/“UserSetSave”

Category	Register	Category	Register
ImageFormatControl	Width	DigitalIOControl	LineInverter
	Height		LineSource
	OffsetX	CounterAndTimerControl	TimerDuration
	OffsetY		TimerDelay
	DecimationHorizontal		TimerTriggerSource
	DecimationVertical	AnalogControl	Gain
	ReverseX		GainAuto
	ReverseY		BlackLevel
	PixelFormat		BalanceRatio
	Gamma		
AcquisitionControl	AcquisitionMode	ALCControl	ALCPhotometricAreaSize
	AcquisitionFrameRate		ALCReferenceLuminance
	TriggerMode		ALCExposureValue
	TriggerSource		ALCTolerance
	TriggerActivation		ALCThrottle
	TriggerDelay		ALCExposureTimeMin
	TriggerSamplingPeriod		ALCExposureTimeMax
	ExposureMode		ALCGainMin
	ExposureTime		ALCGainMax
	ExposureAuto		

## ● Registers

Register	Visibility	Access	Description
UserSetSelector	Beginner	R/W	Selects a bank of user setting.
UserSetLoad	Beginner	W	Executes load of the user setting.
UserSetSave	Beginner	W	Executes to save the user setting.
UserSetDefaultSelector	Beginner	R/W	Selects a bank of user setting when camera powers up.

## ● Setting

- Select a bank of the user setting

Set the following value to “UserSetSelector” register. The setting value is Enumeration type.

Select the bank of user setting for “UserSetLoad” and “UserSetSave”.

Value	Description	Save	Load
Default (*)	Memory bank to read initial factory setting data.	×	○
UserSet1	Memory bank 1 for user setting.	○	○
UserSet2	Memory bank 2 for user setting.	○	○
UserSet3	Memory bank 3 for user setting.	○	○

\* initial factory setting

“Default” bank is only used for loading data. If you want to restore a camera setting to the initial factory setting, please load “Default” bank.

- Load/Save a user setting

When execute “UserSetLoad”, the camera loads the user setting of bank that is selected in “UserSetSelector” register and applies them.

When execute “UserSetSave”, the camera saves a user setting that was applied to the bank that is selected in “UserSetSelector” register.

- Load the user setting at the time of start-up

Set the following value to “UserSetDefaultSelector” register. The setting value is Enumeration type.

When select “UserSetDefaultSelector” register and save it, the camera loads the user setting of bank that is selected in “UserSetDefaultSelector” register and applies them at the time of next start-up.

## ● Note

Changing “UserSetLoad” register value is invalid during image stream data output.

# ALCControl

This section describes ALCControl category for the BG series.

This camera series provides some registers to adjust the various parameter of ALC operation. When the camera operates at ALC, AE operation is prior to AGC operation.

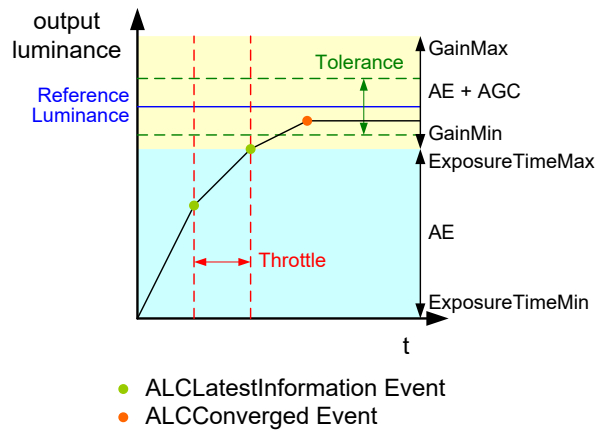

ALC operation

## ● Registers

Register	Visibility	Access	Description
ALCPhotometricAreaSize	Expert	R/W	Selects a photometric area size which is used to measure luminance.
ALCReferenceLuminance	Expert	R/W	Sets a value of the reference luminance when any ALC feature is running.
ALCExposureValue	Expert	R/W	Sets an EV level when any ALC feature is running.
ALCTolerance	Expert	R/W	Sets a tolerance range for the reference luminance when any ALC feature is running.
ALCThrottle	Expert	R/W	Sets a value of feedback fraction when any ALC feature runs.
ALCLock	Expert	R/W	Sets the lock of ALC operation.
ALCExposureTimeMin	Expert	R/W	Sets a minimum value of the exposure time when ALC(AE) feature is running.
ALCExposureTimeMax	Expert	R/W	Sets a maximum value of the exposure time when ALC(AE) feature is running.
ALCGainMin	Expert	R/W	Sets a minimum value of the gain when ALC(AGC) feature is running.
ALCGainMax	Expert	R/W	Sets a maximum value of the gain when ALC(AGC) feature is running.

● **Setting**

- Set photometric area size for measuring luminance

Set the following value to “ALCPhotometricAreaSize” register. The setting value is Enumeration type.

Value	photometric area size
Full (*)	100% (Full pixel)
Medium	64% (H: 80% x V: 80%)
Small	4% (H: 20% x V: 20%)

\* initial factory setting

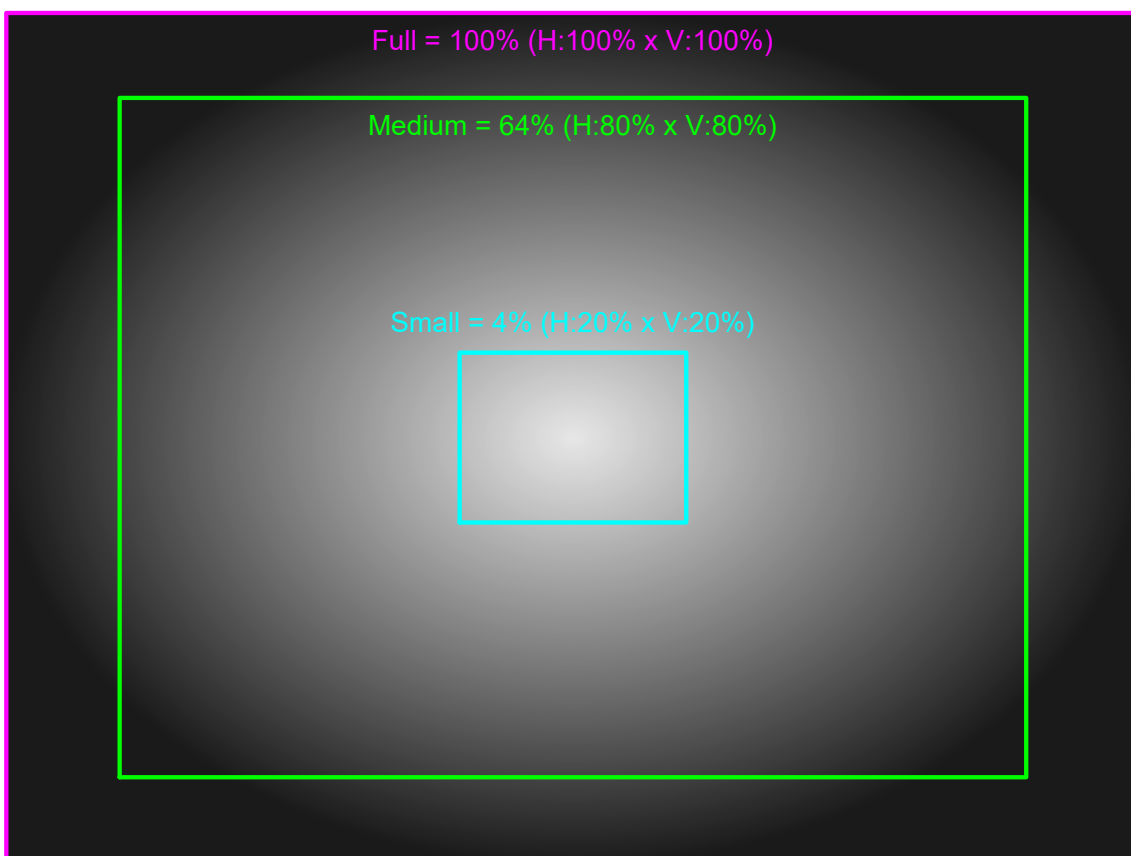

ALC Area

- Set a value of the reference luminance

Set the following value to “ALCReferenceLuminance” registers. These setting values are Integer type.

An Image luminance at ALC operation converges on a reference luminance.

(at ALCExposureValue = 0 [eV]).

ReferenceLuminance	Value
Minimum	0
Maximum	255

\* initial factory setting = 84

- Set a ExposureValue of ALC operation

Set the following value to “ALCExposureValue” register. Setting value is Float type.

When set “ALCExposureValue” register, add a correction value for a convergence value.

ExposureValue	Value
Minimum	-2.00 [eV]
Maximum	+2.00 [eV]

\* initial factory setting = 0.00 [eV]

Final convergence value by setting “ALCExposureValue” register is determined by the following formula.

$$\text{Final convergence value} = \text{ReferenceLuminance} \times 2^{\text{ExposureValue}}$$

- Set a tolerance range of ALC operation

Set the following value to “ALCTolerance” register. Setting value is Float type.

Set convergence tolerance level for the ReferenceLuminance. When tolerance level is small, convergence level become more accurate, but it takes longer time to converge.

Tolerance	Value
Minimum	0.00 [%]
Maximum	50.00 [%]

\* initial factory setting = 1.00 [%]

- Set a value of feedback fraction of ALC operation

Set the following value to “ALCThrottle” register. Setting value is Float type.

Throttle	Value
Minimum	1.00 [%]
Maximum	100.00 [%]

\* initial factory setting = 75.00 [%]

- Set the lock of ALC operation

Set the following value to “ALCLock” register. The setting value is Boolean type.

You can lock ALC operation by using this function.

Value	Activation
FALSE (*)	inactive
TRUE	active

\* initial factory setting

- Set a range of AE operation

Set the following value to “ALCExposureTimeMin”, “ALCExposureTimeMax” register. Setting value is Float type. AE mode operates at a range of a register value.

You shall set “ExposureTimeMin” < “ExposureTimeMax”.

If you set “ExposureTimeMax” longer than a frame rate period, a frame rate may be slower than the register setting.

The range of register setting depends on camera model, and camera operation mode.

AE range	ExposureTimeMin	ExposureTimeMax
Minimum	as same as maximum value of Manual mode	more than ExposureTimeMin
Maximum	less than ExposureTimeMax	as same as minimum value of Manual mode

\* initial factory setting: ExposureTimeMin = minimum value, ExposureTimeMax = 1 frame

- Set a range of AGC operation

Set the following value to “ALCGainMin”, “ALCGainMax” register. Setting value is Float type. AGC mode operates at a range of a register value.

You shall set “GainMin” < “GainMax”.

AGC range	GainMin	GainMax
Minimum	0.00[dB] (*)	more than GainMin
Maximum	less than GainMax	18.00[dB] (*)

\* initial factory setting

● **Note**

ALC operation at Random Trigger Shutter mode is not guaranteed.

# Warranty rules

## ● Warranty term

Warranty term is 36 months after your purchase. We may assume the date of the purchase from our shipping date when the date is unidentified.

## ● Limited Warranty

Free warranty is not applicable for the troubles, damages or losses caused by the cases of the followings, even if it is during the warranty term.

1. Natural exhaust, wear or degradation of a component parts
2. Handling against the instructions and conditions described in the instruction manual
3. Remodeling, adjustment and the part exchange. (including the opening of the enclosure box and the alteration)
4. Using the accessories not included with the product or our non-designated optional articles
5. Damages caused during the transportation or deficiency of the handling such as drop or fall of the products after the products having been transferred to customers, leaving the products to corrosive environment such as sunlight, fire, sand, soil, heat, moisture, or an inappropriate storing method
6. A fire, an earthquake, a flood, a lightning, or other natural disasters, pollution and a short circuit, abnormal voltage, excessive physical pressure, theft, other accident
7. When connected to a product which is not recommended
8. When connected to the power supply which is not suitable
9. Forgery product, products which does not have proper serial number, products of which serial number is forged, damaged or deleted
10. All defects that happened after the expiration for a warranty term

# Repair

- **Repair methods**

Exchange to a replacement or an equal function product.

- **Repair request methods**

On the occasion of a repair request, please download the "Failure situation report sheet" from our website, fill in the necessary items and return it together with the defective product.

Repair Request Methods

[http://www.toshiba-teli.co.jp/en/support/contact/failure\\_situation.htm](http://www.toshiba-teli.co.jp/en/support/contact/failure_situation.htm)

Please read the following instructions carefully.

1. Please return our product alone, taking out of your equipment in case that our product is installed to an equipment
2. We are unable to return the information such as your own serial numbers, control number, the identification seal, if it is attached to the returned products. Please keep record before you return the product.
3. As the data saved in the camera will not be kept after the repair, please take out data before return.
4. We are unable to accept the cancellation after the repair request by the customer's reason.
5. About the repair product shipping expenses, please bear the charges when you return the product to us. We bear the charges to you from us only for a warranty period.
6. We are unable to accept your request of a delivery date and time of the product return, or the delivery method.
7. We are unable to accept a trouble factor investigation, the request of the repair report.
8. We accept a repair of out of warranty product, if it is reparable.
9. The proprietary rights of the repair request products after the exchange repair belong to us.
10. The immunity from responsibility of the product is applied in the repair completion products.

\* Please refer for the inquiry about the software to our homepage or sales personnel.