

B/W CCD Camera CleverDragon series CSCX30BC3 Operation Manual

Thank you for purchasing our B/W CCD camera. This operation manual contains many important information such as how to use this product correctly and safely. Please read through this manual carefully. After reading, keep this manual by the side of this product for your future reference.

TOSHIBA TELI CORPORATION

BEFORE USE - GENERAL SAFETY INSTRUCTIONS

Read the following safety precautions carefully before using this product. These instructions contain valuable information on safe and proper use that will prevent harm and damage to the operator and other persons. Make sure that you fully understand the following details (indications, graphic symbols) before proceeding to the remaining sections in this manual.

OWNER'S RECORD

Please fill in the blank below the model name and product serial number, which is found on bottom chassis of your device. Keep this number for your record.

Model Name _____

Serial No. _____

Indication definitions

Indication	Meaning
	This indicates the existence of a hazard that death or catastrophic bodily injury(*1) may result from improper use.
	This indicates the existence of a hazard that bodily injury(*2) or property damage(*3) may result from improper use.

- Notes
- *1 Catastrophic bodily injury means loss of eyesight, burns (high and low temperature), shock, fracture, poisoning, etc. which leaves a sequela and require hospitalization or prolonged treatment.
 - *2 Bodily injury means injuries, burns and electric shock which does not require hospitalization or prolonged treatment.
 - *3 Property damage means extended harm to home, household effects, domesticated animals, and pets.

Graphic symbol definitions

Indication	Meaning
	This mark indicates a prohibited action that must not be carried out. The actual prohibited action is indicated in the symbol or nearby graphically or described in text.
	This mark indicates a mandatory action that must not be carried out. The actual instruction is indicated in the symbol or nearby graphically or described in text.

Handling Precautions

WARNING	
	Stop operation immediately when any abnormality or defect occurs. Use during an abnormal condition; such as emitting smoke, burning odors, damage from dropping invasion of foreign objects, etc. may cause fire and/or electric shock. Be always sure to disconnect the connection cable from the camera connector at once and contact your dealer.
	Do not operate in places with possibility of becoming wet. This may cause fire and/or electric shock.
	Do not repair, disassemble and/or modify by yourself. This may cause fire and/or electric shock. Be always sure to contact your dealer for internal repair, check and cleaning of the product.
	Don't place things or materials on the unit. Ingress of foreign materials such as metallic things and liquid into the unit may cause a fire or an electric shock.
	Do not put the product in an unstable, slanting and/or vibrated place. Drop and/or fail of the product may cause injury.
	Do not touch the connection cables during a thunderstorm. This might cause electric shock.
	Use the specified power supply. Use of an unspecified power supply may result in fire or electric shock.
	Do not be handled roughly, damaged, fabricated, bent forcefully, pulled, twisted, bundled, placed under heavy objects or heated the connection cable. Otherwise, fire or electric shock may result.

CAUTION	
	Note the following instructions when installing. -Do not wrap the product in an inflammable material, such as cloth. -Do not put the product in a narrow space, since the heat generated from the product may be difficult to emanate. If you do not follow the above, the heat generated by the product may cause fire.
	Avoid setting in humid, smoky, vaporized or dusty places. A fire or an electric shock may occur in such places. This may cause fire and/or electric shock.
	Do not put the product in direct sunshine and/or high temperature. The temperature inside the product may cause fire.
	Use the specified connection cable. Otherwise, a fire or an electric shock may occur.
	Turn OFF the power in the case of connection. Turn OFF the power in the case of cable. Otherwise, an electric shock or a malfunction may occur.
	Do not expose its camera head to any intensive light (such as direct sunlight). Otherwise, its inner image pickup device might get damaged.
	Avoid short-circuiting signal output. Otherwise, a malfunction may occur.
	Avoid giving a strong shock against the camera body. It might cause a breakdown or damage. If your camera is used in a system where its camera connector is subjected to strong repetitive shocks, its camera connector is possible to break down. If you intend to use your camera in such a situation, if possible, bundle and fix a camera cable in the place near the camera, and do not transmit a shock to the camera connector.
	Ask your dealer to perform a periodical check and internal cleaning (approx. once every five years). Dust inside the product may cause fire and/or trouble. For check and cleaning cost, please consult your dealer.

DISCLAIMER (LIMITED WARRANTY)

We disclaim any responsibility and shall be held harmless for any damages or losses incurred by the user in any of the following cases:

- Fire, earthquake or any other act of God; acts by third parties; misuse by the user, whether intentional or accidental; use under extreme operating conditions.
- Malfunction or non-function resulting in indirect, additional or consequential damages, including but not limited to loss of expected income and suspension of business activities.
- Inconrent use not in compliance with instructions in this instruction specifications and manual.
- Malfunctions resulting from misconnection to other equipment.
- Repairs or modifications made by the user or caused to be made by the user and carried out by an unauthorized third party.
- Notwithstanding the foregoing, Teli's liabilities shall not, in any circumstances, exceed the purchase price of the product.
- About the item which does not have a publication in the specifications and manual of this product, it considers as the outside for a guarantee.

RESTRICTION FOR USE

- Should the equipment be used in the following conditions or environments, give consideration to safety measures and inform us of such usage:
 1. Use of the equipment in the conditions or environment contrary to those specified, or use outdoors.
 2. Use of the equipment in applications expected to cause potential hazard to people or property, which require special safety measures to be adopted.
- This product can be used under diverse operating conditions. Determination of applicability of equipment or devices concerned shall be determined after analysis or testing as necessary by the designer of such equipment or devices, or personnel related to the specifications. Such designer or personnel shall assure the performance and safety of the equipment or devices.
- This product is not designed or manufactured to be used for control of equipment directly concerned with human life (*1) or equipment relating to maintenance of public services/functions involving factors of safety (*2). Therefore, the product shall not be used for such applications.
 - (*1): Equipment directly concerned with human life refers to.
 - Medical equipment such as life-support systems, equipment for prerating theaters.
 - Exhaust control equipment for exhaust gases such as toxic fumes or smoke.
 - Equipment mandatory to be installed by various laws and regulations such as the Fire Act or Building Standard Law
 - Equipment related to the above.
 - (*2): Equipment relating to maintenance of public services/functions involving factors of safety refers to.
 - Traffic control systems for air transportations, railways, roads, or marine transportation
 - Equipment for nuclear power generation
 - Equipment related to the above

CAUTIONS ON USE

- Carefully handle the units.
Do not drop, or give a strong shock or vibration to the camera. This may cause problems. Treat the camera cables carefully to prevent cable problems, such as cable breakdown and loosened connections.
- Operating ambient temperature and humidity.
Do not use the camera in places where temperature and humidity exceed the specifications. Picture quality will lower and internal parts may be damaged.
Be particularly careful when using in places exposed to direct sunlight. When shooting in hot places, depending on the conditions of the object and the camera (for example when the gain is increased), noise in the form of vertical strips or white dots may occur. This is not a malfunction.
- Restriction for the lens combination
This camera might form a ghost to image area depending on the combination of a lens and an illumination with this camera. But this is not a failure of this camera. Therefore, please check the combination of the lens and the illumination with this camera when use.
When mounting a lens, take extra caution so that the lens is not tilted, nor does flaw exist at the lens-mount-screw part. Also check to confirm that no dirt nor other foreign object is put inside
Improper mounting might cause the parts to become locked.
- Do not shoot under intense light.
Avoid intense light such as spot light on part of the screen because it may cause blooming or smears. If intense light falls on the screen, vertical stripes may appear on the screen, but this is not a malfunction.
- Do not expose the camera's image-pickup-plane to sunlight or other intense light directly.
Its inner CCD (charge-coupled device) might be damaged.
- Moire
When thin stripe patterns are shot, stripe patterns that are not actually there (moire) may appears as interference stripes. This is not a malfunction.
- Undesirable noise
If the camera or the cables are located near something which emit strong magnetism or near something which emit strong electric wave, undesirable noise may appear on the screen. In such a case, try to change the location of the camera or the cable wiring.
- Handling of the protection cap
When the camera is not in use, put a lens-cap onto the camera head for protection of the image-pickup-plane.
- When not using the camera for a longtime.
Stop supplying power for safety.
- When cleaning the camera
Always turn off the power and clean with a piece of soft dry cloth.
To remove stubborn stains, use a soft cloth soaked in diluted acid-free detergent. Do not use alcohol, benzine, thinner, etc. If used, coating and printed letters may be discolored.
In case the image-pickup-plane should be settled with fine dust, dirt, or scratched, ask your dealer for technical advice.
- Wastes of this product should be separated and discarded in compliance with the various national and local ordinances.

This device complies with Part 15 of the FCC rules. Operation is subject to the following two conditions:

- (1) This device may not cause harmful interference, and
- (2) This device accept any interference received, including interference that may cause undesired operation.

This equipment has been tested and found to comply with the limits for a class A digital device, pursuant to Part 15 of the FCC Rules. These limits are designed to provide reasonable protection against harmful interference when the equipment is operated in a commercial environment. This equipment generates, uses, can radiate radio frequency energy and, if not installed and used in accordance with the instruction manual, may cause harmful interference to radio communications. Operation of this equipment in a residential area is likely to cause harmful interference in which case the user will be require to correct the interference at his own expense.

1. PRODUCT DESCRIPTION

CleverDragon series CSCX30BC3 is an integrated type B/W CCD camera with a XGA format all-pixel-data readout CCD. The model is suited for high-speed, high-resolution image processing use. Its compact, light-weight body is ideal for system integration.

2. FEATURES

- (1) All-pixel reading
The all-pixel reading system allows the CSCX30BC3 to read all pixels in just 1/30 second. CSCX30BC3 is equipped with a full-frame shutter that allows all-pixel reading even during shutter operations.
- (2) Full-frame shutter
Since all pixels are output even by a random trigger shutter operation, high resolution can be achieved, without deteriorating the vertical resolution.
- (3) Tetragonal lattice layout
The tetragonal lattice layout of CCD pixels facilitates computation for image processing.
- (4) Camera Link interface (power supply type)
By using a Camera Link-capable frame grabber board to which power can be supplied, high-speed transfer of captured images to a PC as well as various types of camera control from the PC are allowed. Power can also be supplied to the camera with only one cable.
- (5) Random trigger shutter function
CSCX30BC3 is equipped with a random trigger shutter, which starts exposure synchronized with external trigger signals. Fast-moving objects can thus be captured in place, which ensures accurate image processing.
- (6) Restart-Reset
Images can be shot and fetched at arbitrary timing based on external VD signal input.
- (7) Partial scan
Speed is further increased because areas other than the image output range specified by the user are not read.
- (8) Ultra-compact and lightweight main unit
The space-saving ultra-compact and lightweight camera has excellent resistance against vibration and impact.
- (9) Conformity to RoHS directive
CSCX30BC3 is manufactured in compliance with the European RoHS directive, which prohibits the use of hazardous substances.

3. CONFIGURATION

- (1) Camera body 1
- (2) Accessory
Operation Manual(Japanese) 1
Operation Manual(English) 1

4. OPTION PARTS

- (1) Camera-mounting kit Model name : CPT8560
*Contact your dealer / distributor for details of option units.
*Application software is not supplied as a standard item.

5. INTERFACE

Video output/controlling/power supply connector: (Camera Link Base Configuration) CAMERA LINK
Outputs video signals and VALID, based on the camera link standard LVDS.
This connector is connected to the frame grabber board, image processing device and others.
And it is possible to supply the power to the camera, by using an exclusive Camera Link cable and frame grabber board complied with Power over Camera Link standard.

Connector model: HDR-EC26FDTG2+ (Manufactured by Honda Connectors)

Pin #	I/O	Signal name	Pin #	I/O	Signal name
1	-	+12V	14	-	GND
2	O	TxOUT0-	15	O	Tx OUT0+
3	O	TxOUT1-	16	O	Tx OUT1+
4	O	TxOUT2-	17	O	Tx OUT2+
5	O	TxCLK OUT-	18	O	Tx CLK OUT+
6	O	TxOUT3-	19	O	Tx OUT3+
7	I	SerTC(RxD)+	20	I	SerTC(RxD)-
8	O	SerTFG(TxD)+	21	O	SerTFG(TxD)+
9	I	CC1(TRIG/VD)-	22	I	CC1(TRIG/VD)+
10	I	CC2+	23	I	CC2-
11	I	CC3-	24	I	CC3+
12	I	CC4+	25	I	CC4-
13	-	GND	26	-	+12V

*Please confirm the power supply of the camera cuts when the connector is connected or pulls out. It causes the breakdown etc.

6. CONNECTION EXAMPLES

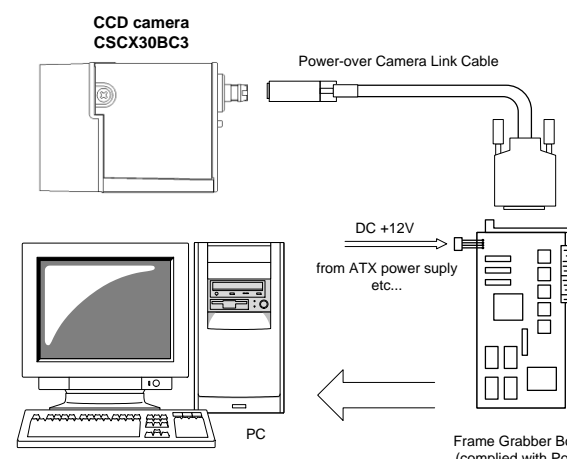

7. FUNCTIONS

By accessing the camera register published on the camera link I/F, you can control/set each function. Since access to the camera register is performed via the frame grabber board, the controlling and setting methods differ depending on the frame grabber board you use. For details, refer to the instruction manual of the relevant frame grabber board or contact our sales representative.

This instruction manual describes the specifications in the case where the camera register is directly connected by serial transmission over the camera link interface.

For details of the control and setting of functions, refer to "Interface Specification". Please ask your distributor or a sales representative about "Interface Specification".

7-1. Explanation of Each Function

- (1) Readout mode
Video is output from the camera link connector. The output video can be grabbed by the frame grabber board. The frame rate and resolution of output images that this model supports are as follows:
 - All pixel read out 29.99 fps (MAX) / 1024(H)×768 (V)
 - Partial Scan 29.99 fps to 85.14 fps (depend on Partial scan width)
Horizontal resolution: 1024 (fixed)
Partial Scan Video Start Line: 0 to 576
Partial Scan Video Width: 192 to 768

- (1-1) All pixel read out
Address: 0x90, Bit: 0, Value: 0
As all pixels are read out in approx. 1/30s, you will get images with the higher V resolution (you have to change the shutter speed to 1/30s or shorter).

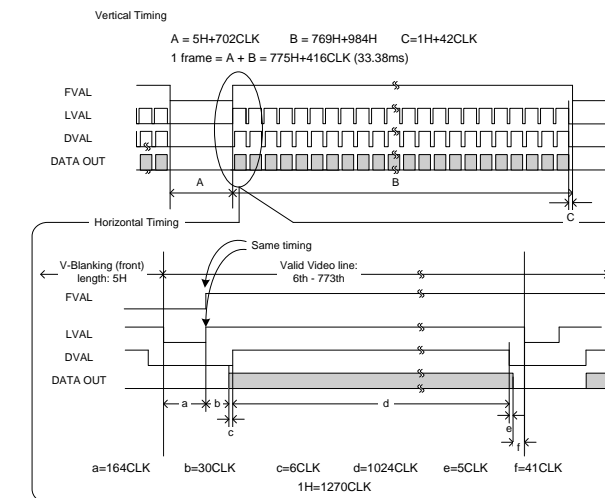

- (1-2) Partial Scan
Address: 0x90, Bit: 0, Value: 1
Speed is further increased because areas other than the image output range specified by the user are not read. Partial scan setting procedure is following:
 - Video start line Address: 0xC4, Bit: 0 to 9, Value: 576
 - Video output width Address: 0xC8, Bit: 0 to 9, Value: 192 to 768
 - Partial scan update Address: 0xC0, Bit: 0, Value: 1
 - If you want maximum frame rate, you must shorten the shutter speed.

ex. 1) Video Start Line=192, Video Width=384 (maximum speed on all pixel readout mode)

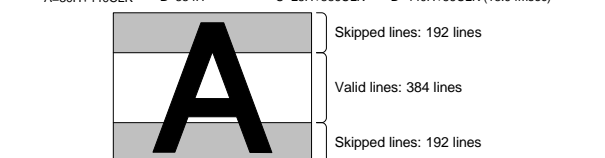
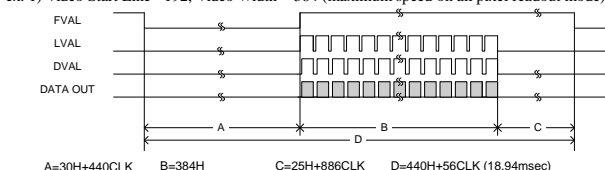

- ex. 2) Video Start Line=288, Video Width=192 (maximum speed on all pixel readout mode)

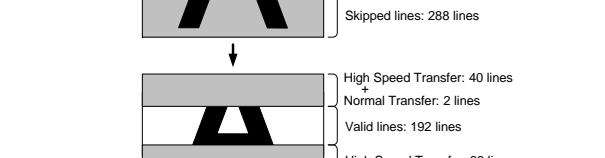
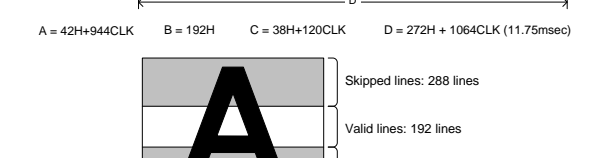
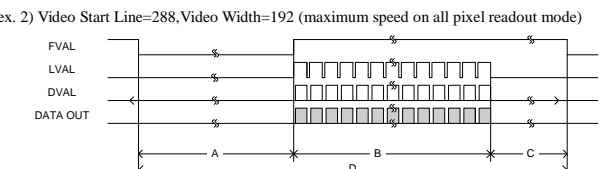

- (2) Setup Addition Value **Address: 0x70, Bit: 0 to 7, Value: 0 to 255**
You can add the offset level to the reference black level.

Setup Addition (calculated value)	Setting Range (a)	Calculation formula
+0 to 255 [digit] (10bit)	0x00 to 0xFF (0 to 255)	+ a [digit] (10bit)
+0 to 63 [digit] (8bit)	0x00 to 0xFF (0 to 255)	+ a/4 [digit] (8bit)

- (3) Gain **Address : 0x76, Bit : 0 to 6, Value:0 to 90**
You can set Gain (video gain).

Gain (calculated value)	Setting Range	Calculation formula
0 to approx. +12dB	0x00 to 0x5A (0 to 90)	0.132dB × Gain

Notes on gain setting:

It is possible to set a maximum of +12 dB (Calculation value) but the warranty range for this product is 0 to +10 dB. When using this product, be sure to set a gain value within the warranty range.
And, Setting a too high gain value can increase noise. When you adjust the brightness of the shot image, you are responsible for finally confirming the image quality by using the entire machine/equipment.

- (4) Electronic shutter
The exposure time has the format (numerator/denominator).
The numerator and denominator can be set separately in respective registers.
1 frame length depends on the shutter speed.

- Numerator **Address: 0xA4, Bit: 0 to 7, Value: 1 to 255**
Denominator **Address: 0xA0, Bit: 0 to 14, Value: 1 to 20000**

*When you set the exposure time longer than approximately 1 second, white spots and the unevenness in highlight portion might occasionally be observed on screen. This phenomenon is due to the characteristics of the CCD image-pickup device, and do not reflect performance error in the pickup device or CCD Camera itself.

- (5) Random trigger shutter **Address: 0x91, Bit: 0, Value:1**

In the random trigger shutter mode, you can shoot and grab an image at an arbitrary timing by trigger signal input from the external.

- External trigger signals can be input from the camera link I/F CC1.
- If polarity is set to negative polarity, exposure starts at the falling edge of the trigger. **Address: 0x93, Bit: 0, Value:0 is Negative Polarity, Value:1 is Positive Polarity**
- The random trigger shutter of this camera can be operated in two types of mode: fixed mode and pulse width mode. How to determine the exposure time differs depending on the mode.

- (5-1) Fixed mode **Address: 0x92, Bit: 0, Value: 0**

The exposure time is determined by the setting value for the shutter speed.

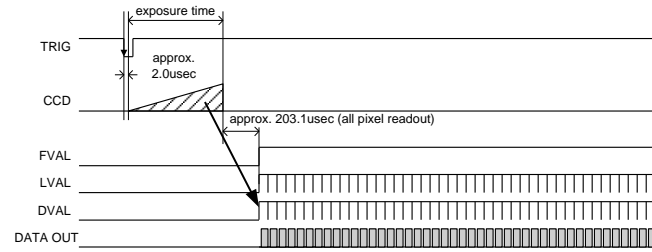

- (5-2) Pulse width mode **Address: 0x92, Bit: 0, Value: 1**

The exposure time is determined by the pulse width.
Set a pulse width of 1H (approximately 43.1 μs) or more.

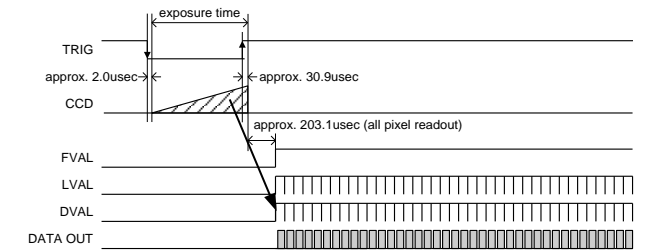

- (6) Restart Reset **Address: 0x91, Bit: 0 to 1, Value:2**

The restart / reset function is available with the ext.VD signal. You can get an arbitrary slower shutter speed than normal shutter and random trigger shutter.

- External VD signals can be input from the camera link I/F CC1.
- If polarity is set to negative polarity, exposure starts at the falling edge of the trigger. **Address: 0x93, Bit: 0, Value:0 is Negative Polarity, Value:1 is Positive Polarity**

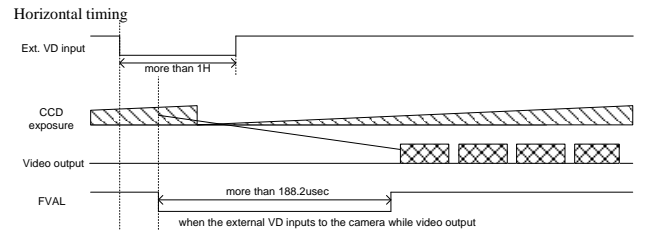
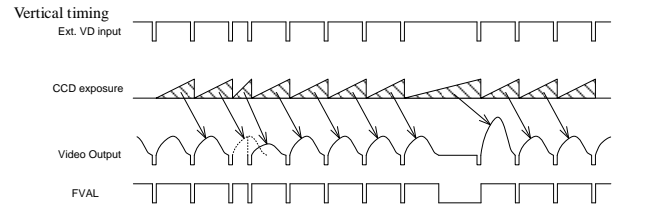

- (7) Output bit **Address: 0x87, Bit: 0 to 3, Value: 8 or 10**

You can set gray scale per pixel. The initial factory setting is 8 (8 bit).

7-2. Command Communication Protocol
The command communication protocol is the telnet standard method (method in which parameters are set in the registers in the camera).
In command send/receive operation, hexadecimal address and data are converted to ASCII data.
All ASCII alphabetic characters used are uppercase characters.

- (1) Writing to the register
To write data in a register, send a command, as follows. (Address' max-length is 2 bytes, and Data's max-length is 8 bytes)

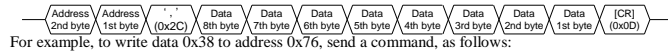

For example, to write data 0x38 to address 0x76, send a command, as follows:
7 6 3 8 [CR]

The camera responds to the write command with No Error (ACK) or Error (NAK), as follows:

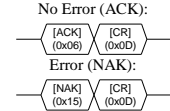

- (2) Reading the register
To read data from a register, send ', (comma)', 'R', 'Q' and [CR] code following the address. For example, to read data in address 0x91, send a command, as follows:

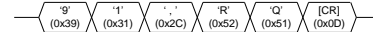

The camera responds to the read request, as follows (Data's max-length is 8 bytes):

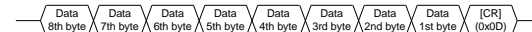

Actually, the camera responds to the read request as minimum data length: For example, to read data 0x10 to address 0x91, the camera responds as follows:

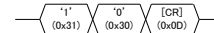

- 7-2. Error Status
If NAK is returned to the sent command, you can obtain detailed information on the error by accessing the status register.

Error type	Details of error	Status [0x69]	Expansion Status [0x6A]
No Error	No error	0x00	0x00
Communication Error	A packet format error was detected.	0x01	0x01
	An overrun error was detected.		0x02
	An framing error was detected.		0x03
General Accessing Error	The data length of the command is beyond the specified upper limit.	0x02	0x04
	The reserved area was accessed.		0x01
	You attempted a read access to a Write Only Register. You attempted a write access to a Read Only Register. The setting value is out of the specified range.		0x03
FlashRom Accessing Error	FlashRom access error	0x03	0x01
User Setting Read Error	You load your saved setting when any saved setting data is not available.	0x04	0x01
Partial Mode Related Error	You changed registers related partial scan mode when you select all pixel read-out mode.	0x05	0x01
Shutter Related Error	You attempted to set a shutter speed beyond the specified range.	0x06	0x01
	You changed Random Trigger shutter mode when you select Normal Shutter mode or Restart-Reset		0x02
	You changed trigger polarity when you select Normal Shutter mode.		0x03

8. BEFORE DETERMINING IT AS BEING A FAULT

If any trouble occurs in use, check the following first.
If the trouble persists, contact your distributor or our sales representatives.

Phenomena	Check item
Cannot turn on power	Check the connection of the CameraLink(PoCL) frame grabber board and CameraLink
Shooting image is not displayed	Check the connection of the CameraLink(PoCL) frame grabber board and CameraLink
	Check that the camera register are correct.
	Check that lens aperture is not closed.
Frame drop occurs on shooting image	Check that the CameraLink(PoCL) grabber board is installed and set up correctly.
	If more than one boards are installed in the PCI slots, remove the other boards.
Shooting image remains still	Check that the camera is not in the random trigger mode.
	Check the setting of the CameraLink(PoCL) grabber board.
Cannot control camera from PC	Check the connection of the CameraLink(PoCL) frame grabber board and CameraLink
	Check that the CameraLink(PoCL) grabber board is installed and set up correctly.

9. SPECIFICATIONS

- [Basic specification]
- Image sensor: all-pixel-data-readout interline transfer CCD
Total pixels: 1077(H) × 788(V)
Active pixel: 1034(H) × 779(V)
Video output pixels: 1024(H) × 768(V)
Scanning area: 4.81 (H) × 3.62(V) mm (= Equivalent to 1/3" type CCD size)
Unit cell size: 4.65μm(H) × 4.65μm(V)
 - Scan method: Non-interlace
 - Synchronization method: Internal synchronization
 - Aspect ratio: 4:3
 - Video Output: Compliant with CameraLink standard version 1.2
Data: 10 / 8 bit switching (factory default: 8bit)
Readout mode: All pixel readout (default): 1024(H) × 768(V) [29.99 fps]
Partial Scan (representing value): 1024(H) × 384(V) [52.75 fps]
1024(H) × 192(V) [85.14 fps]
minimum video output lines: 192, minimum step: 1 line
 - Sensitivity: 400 lx, F5.6
 - Minimum subject illuminance: 4lx F1.4 (GAIN: 10dB, video level: 50 %)
 - Gain: 0 to Approx. +12 dB [1step= Approx. 0.132dB]

- Setup Level (factory default): 40 ± 20 [digit] (10bit)
10 ± 5 [digit] (8bit)
(addition value): +0 to +255 [digit] (10bit, 255 steps)
+0 to +63 [digit] (8bit, 255 steps)
- Gamma correction: OFF (γ = 1.0 fixed)
- Power supply voltage: DC12V ± 10% (ripple 50mV_{p-p} or less)
- Power consumption: Approx. 1.3W

- [Electrical shutter specification]
- Shutter Speed: 8/1 to 1/20,000 [sec]
Setting format: Numerator / Denominator [sec]
Numerator : 1 to 255
Denominator: 1 to 20,000
ON / OFF switching (factory default: OFF)
The exposure time depends on the shutter speed setting
The exposure time depends on the pulse width.

- Random Trigger Shutter: Fixed mode, Pulse width mode
- Restart-Reset: ON / OFF switching (factory default: OFF)
The exposure time depends on the period of Ext. VD.

- [Internal sync signal specification]
- Driving frequency: 29.50 MHz (1 CLK) ± 100ppm
 - Horizontal sync frequency: 23.22 kHz (1H = 1270CLK)
 - Vertical sync frequency: 29.99 Hz (maximum frequency on all pixel readout mode)

- [Input signal specification]
- TRIG/VD: Camera Link interface input: CC1
Polarity: Positive/Negative switching (factory default: negative)
Pulse width: Minimum: 2μs

Notes of trigger mode:

*When the interval of the input trigger signal is extremely short, or when the trigger signal is noisy, there is a possibility of causing the malfunction. In this case, please input a proper trigger signal.

- [Mechanical spec]
- Lens mount: C-mount
*Depending on the lens you use, the performance of the camera may not be brought out fully due to the deterioration in resolution and brightness in the peripheral area, occurrence of the ghost, aberration and others. When you check the combination between the lens and camera, be sure to use the lens you actually use.
*Install a next lens; the C mount lens, its dimension of protrusion from flange is equal to or less than 7.9 mm. If a lens does not stand to this condition, it might not be installed to this camera.
 - Flange back: 17.526mm
 - Dimensions: 29mm(W) × 29mm(H) × 26.5mm(D)
* Not including protrusion
 - Mass: Approx. 45g
 - Camera body grounding: Conductive between circuit GND and camera body

- [Operating ambient conditions]
- Performance assurance: Temperature: 0°C to +40°C
Humidity: 10% to 90% (no condensation)
 - Operation guaranteed: Temperature: -5°C to +45°C
Humidity: 90% or less (no condensation)
 - Storage: Temperature: -20°C to +60°C
Humidity: 95% or less (no condensation)
 - EMC conditions (Electro-Magnetic Compatibility): EMI (Electro-Magnetic Interference): EN61000-6-4
EMS (Electro-Magnetic Susceptibility): EN61000-6-2
FCC Part 15 Subpart B class A

- [Communication specification]
- Communication speed: 9600 bps (fixed)
 - Start bit: 1
 - Data bit: 8
 - Parity: None
 - Stop bit: 1
 - Handshake: None

[Camera PSU input impedance]

$$C_i \leq 57\mu F, R_x = 10k\Omega \pm 10\%$$

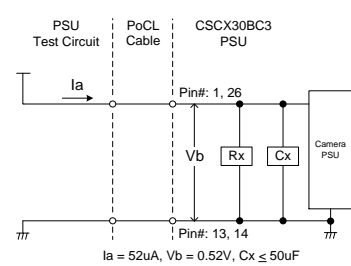

[Relative Spectrum Response]

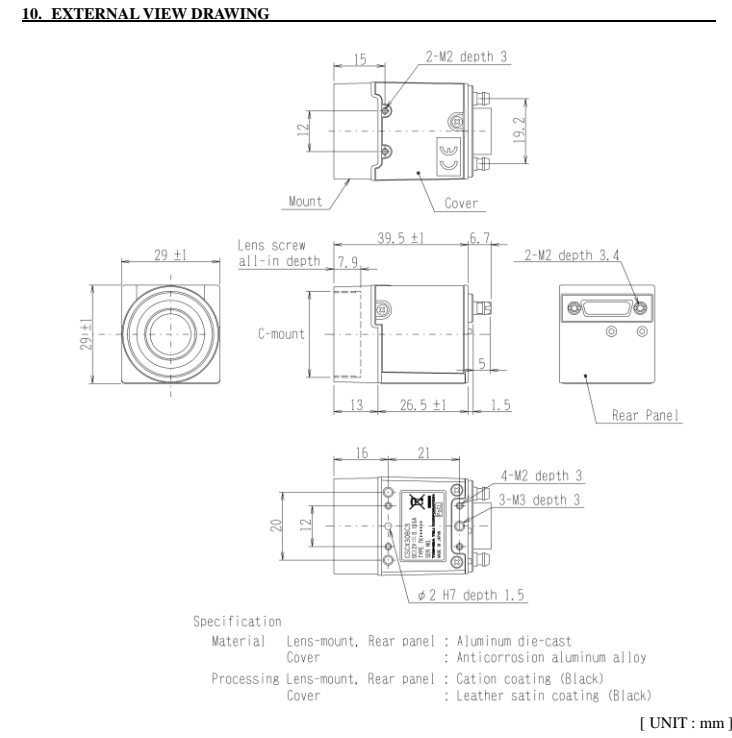
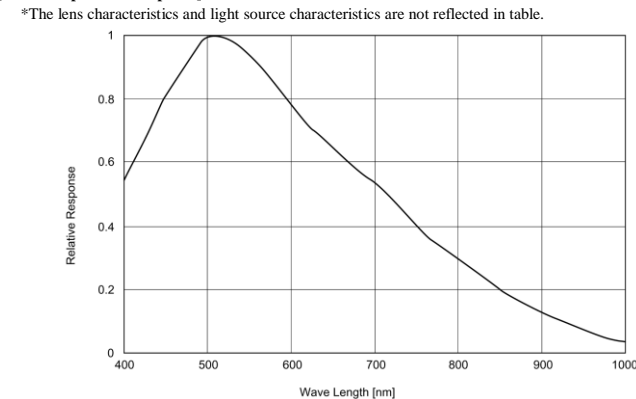

Following information is only for EU-member states:
The use of the symbol indicates that this product may not be treated as household waste. By ensuring this product is disposed of correctly, you will help prevent potential negative consequences for the environment and human health, which could otherwise be caused by inappropriate waste handling of this product. For more detailed information about the take-back and recycling of this product, please contact your supplier where you purchased the product.

This symbol is applicable for EU member states only"

环保使用期限标识，是根据电子信息产品污染控制管理办法以及，电子信息产品污染控制标识要求(SJ/T11364-2006)、电子信息产品环保使用期限通则，制定的适用于中国境内销售的电子信息产品的标识。电子信息产品只要按照安全及使用说明内容，正常使用情况下，从生产月期算起，在此期限内，产品中含有的有毒有害物质不致发生外泄或突变，不致对环境造成严重污染或对其人身、财产造成严重损害。产品正常使用后，要废弃在环保使用年限内或者刚到年限的产品时，请根据国家标准采取适当的方法进行处置。另外，此期限不同于质量/功能的保证期限。
The Mark and Information are applicable for People's Republic of China only.

中华人民共和国
环保使用期限

<产品中有害物质或元素的名称及含量>

部件名称	有毒有害物质或元素					
	铅 (Pb)	汞 (Hg)	镉 (Cd)	六价铬 (Cr(VI))	多溴联苯 (PBB)	多溴二苯醚 (PBDE)
相机本体	×	○	○	○	○	○

○：表示该有害物质在该部件所有均质材料中的含量均在电子信息产品中有毒有害物质的限量要求标准规定的限量要求(SJ/T11363-2006)以下
×：表示该有害物质至少在该部件的某一均质材料中的含量超出电子信息产品中有毒有害物质的限量要求标准规定的限量要求(SJ/T11363-2006)
This information is applicable for People's Republic of China only.

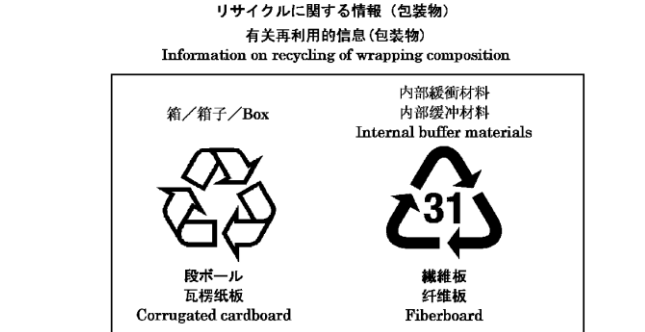

TOSHIBA TELI CORPORATION
Head Office: 7-1, 4 chome, Asahigaoka, Hino-shi, Tokyo, 191-0065, Japan
(Overseas Sales Department)
Phone : +81-42-589-8771
FAX : +81-42-589-8774
URL : <http://www.toshiba-teli.co.jp>

The design and specification is subject to change without notice.